

IPD-2HP

OWNERS MANUAL

Congratulations on your purchase of the IPD-2HP Rear Seat Entertainment Mount. Please read the instruction manual for this product before using it. The documentation provided will allow you to enjoy all the features this product has to offer. Please save this manual for future reference.



The IPD-2HP Rear Seat Entertainment Mount is Made for iPad®. Supported models include:

- New iPad
- iPad 2

“Made for iPad” means that an electronic accessory has been designed to connect specifically to iPad and has been certified by the developers to meet Apple performance standards. Apple is not responsible for the operation of this device or its compliance with safety or regulatory standards. Please note that the use of this accessory with iPad may affect wireless performance. iPad is a trademark of Apple Inc., registered in the U.S. and other countries.

FCC Notice

This device complies with part 15 of the FCC Rules. Operation is subject to the following two conditions: (1) This device may not cause harmful interference, and (2) this device must accept any interference received, including interference that may cause undesired operation.

Warning! Changes or modifications to this unit not expressly approved by the party responsible for compliance could void the user's authority to operate the equipment.

Licensed under one or more of the following patents:

Patent Numbers: 8,109,569 and 6,678,892.

What's In the Box?



Protective Case

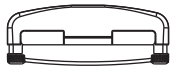

**Universal
Seatback Dock**



**Vehicle DC
Power Adaptor**



Manual

Features

- Easily docks and undocks to the seatback by a Quick Connect attachment mechanism
- Universal Seatback Dock can be installed on driver or passenger side
- Six depth settings to allow proper fitting to the seat depending on the size of the headrest
- Adjustable tilt (up or down)
- Protective case
- Charges the iPad when plugged into the vehicle power source
- Built-in DC charging port (for use with optional Home Power Supply)
- Built-in infrared (IR) headphone transmitter

Front

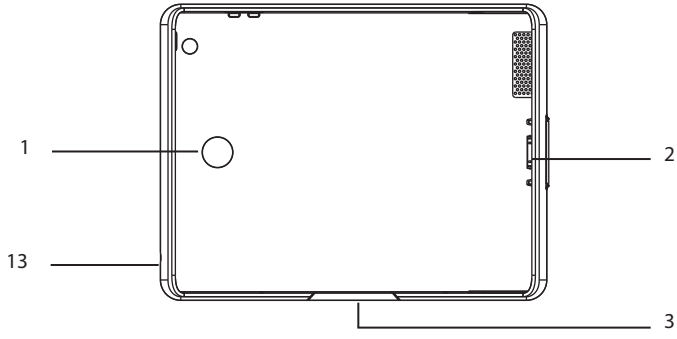

Back

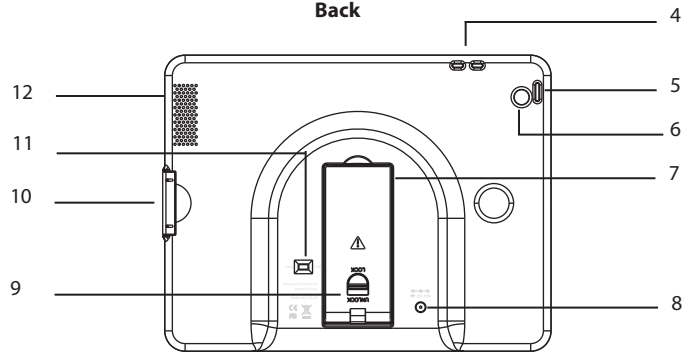

1. Finger Push Out Window
To push out the iPad from the Protective Case.
2. 30 Pin Connector
3. IR Transmitter
Used to broadcast audio signals to the wireless IR headphones (not included).
4. Volume -/Volume + Buttons
5. Power On/Off Button
To turn the iPad on or off.
6. Camera Lens Window
7. Mounting Arm
Attaches and locks the Protective Case to the Universal Seatback Dock.
8. DC 12V Charging Port
Power in jack for 12 V/1.5 A power adapter.
9. Red Switch
Hold to lock or unlock the Mounting Arm into Universal Seatback Dock.
10. Locking Key
Used to insert or release the iPad.
11. CH A/CH B Channel Switch
Select CH A or CH B to match the wireless IR Headphone channel.
12. Speaker Port
13. 3.5 mm Audio Out Port

To insert your iPad into the Protective Case:

1. Make sure the Locking Key is in the closed (pushed in) position so that it is flush within the case.

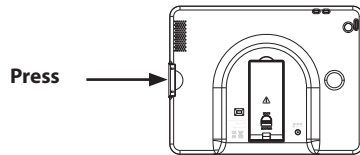

2. Slide your iPad into the Protective Case. Match the iPad charging connector with the Protective Case's 30 Pin Connector position and gently pull the Locking Key out while sliding the iPad into the case.

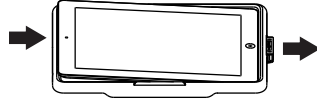

3. Push your iPad down into the Protective Case.



4. When your iPad is inside the Protective Case, slide the iPad to the left while at the same time pushing in the Locking Key.

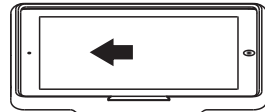

5. Press the Locking Key to ensure the iPad is held firmly by the Protective Case.

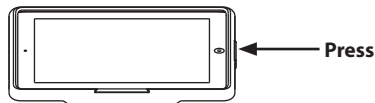

To remove your iPad from the Protective Case:

1. Hold the iPad and Protective Case vertically.
2. Pull the Locking Key gently while holding the Protective Case in a vertical position. The iPad will slide down.

Note: Please do not pull the Open Key too hard when removing your iPad from the Protective Case to prevent damaging the locking parts.



3. Use your index finger to push your iPad out of the Protective Case using the Finger Push Out Window.

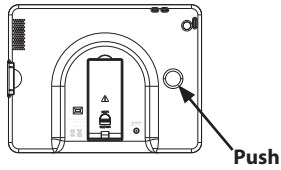

4. Remove your iPad from the Protective Case in the indicated direction.

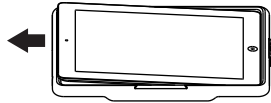

To install the Universal Seatback Dock on the Headrest:

The Universal Seatback Dock can be installed on either the driver or passenger seat.

1. Adjust the headrest position.

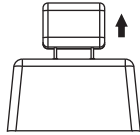

2. Plug one end of the Vehicle DC Power Adapter into the DC 12V Charging Port on the bottom of the Universal Seatback Dock.

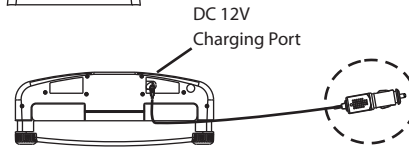

3. Turn Screws (A) counterclockwise and remove the Screws to disassemble the Universal Seatback Dock.

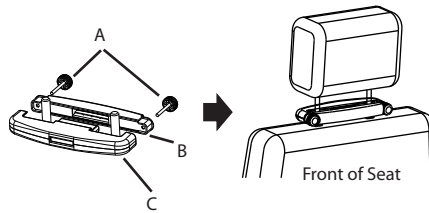

4. Clamp the Front Bracket (B) and Rear Bracket (C) around the headrest posts. Note the location of the bottom side engraved on the Rear Bracket. Ensure that this side is facing down and the slot is facing the rear of the vehicle.

5. Secure the brackets in place with the Screws. Turn the Screws clockwise and hand tighten.

6. Plug the other end of the Vehicle DC Power Adapter into the Vehicle DC Accessory Socket of your car.

To attach the Protective Case to the Universal Seatback Dock:

The Mounting Arm has six depth settings to allow for proper fitting to the seat depending on the size of the headrest.

Warning! Always make sure the Red Switch is in the UNLOCK position when inserting or removing the Mounting Arm, otherwise damage will occur to both units.

1. Hold the Red Switch in the UNLOCK position.
2. While holding the Red Switch in the UNLOCK position, insert the Mounting Arm into the slot in the Rear Bracket.
3. Once the Mounting Arm is inserted into the Rear Bracket sufficiently, release the Red Switch so that it returns to the LOCK position.

Warning! Ensure the Mounting Arm is inserted and locked in the Rear Bracket before moving your vehicle.

4. Adjust the tilt angle to the desired viewing position.

Fully inserted and locked-in position

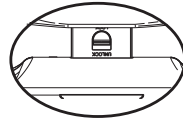

First locked-in position

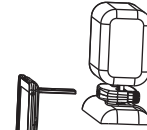
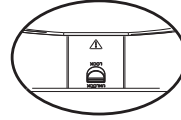

To remove the Protective Case from the Universal Seatback Dock:

1. Hold the Red Switch in the UNLOCK position.
2. At the same time, pull the Mounting Arm out of the Rear Bracket.
3. When the Mounting Arm is fully removed from the Rear Bracket, release the Red Switch so that it returns to the LOCK position.

To charge your iPad in your car or at home:

In car charging:

Plug one end of the Vehicle DC Power Adapter into the DC 12V Charging Port on the bottom of the Universal Seatback Dock, then plug the other end into the Vehicle DC Accessory Socket of your car.

At home charging:

Plug one end of the Home AC/DC Power Adapter (Part Number IPD-HPS, not included) into the DC 12V Charging Port on the back of the Protective Case, then plug the other end into an electrical outlet.

To Use the IR Transmitter:

The IPD-2HP Rear Seat Entertainment Mount has a built-in two channel infrared audio transmitter for use with wireless Infrared Headphones (sold separately).

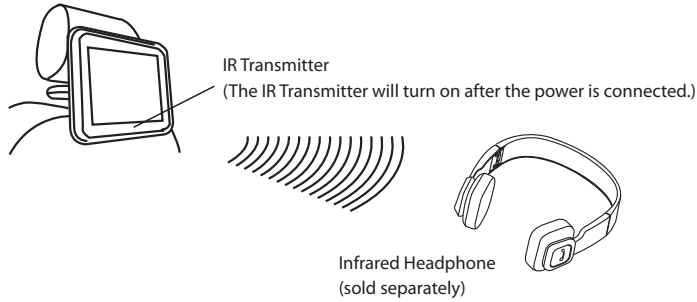

1. Connect the power supply to the Universal Seatback Dock.
2. Select CH A or CH B. The channel selected must match the channel of the Infrared Headphone (sold separately) that you are using.
Note: If two IPD-2HPs are installed in a vehicle, set one unit to CH A and the other to CH B. Set the two channel headphones accordingly.
3. For best audio quality, turn the volume of the iPad to maximum and adjust the wireless headphone volume to a comfortable listening level.

To ensure good reception:

The wireless IR Headphone must be used within a line of sight from the IR Transmitter as infrared transmission, like visible light, travels only in an unrestricted line of sight.

To disable the IR Transmitter when the power is connected and enable iPad speaker mode:

During Play Mode, press PAUSE, PLAY, PAUSE, PLAY, PAUSE, PLAY in sequence within three seconds.

To resume infrared transmission:

1. Remove the Protective Case from the Universal Seatback Dock.
2. Reinsert the Protective Case on to the Universal Seatback Dock (this will reconnect the power supply).

Troubleshooting

Problem	Cause	Solution
The Protective Case does not fit into the Mounting Arm.	<ul style="list-style-type: none">• Red Switch is not unlocked when you are inserting the Protective Case into the Universal Seatback Dock.• Universal Seatback Dock is upside down.	<ul style="list-style-type: none">• Hold Red Switch in UNLOCK position.• Repeat installation steps again.
The iPad can not be charged.	<ul style="list-style-type: none">• Power supply is not properly connected.	<ul style="list-style-type: none">• Use the Vehicle DC Power Adapter for in-car application, use the Home AC/DC Power Adapter at home.
The IR Transmitter does not work.	<ul style="list-style-type: none">• Incorrect channel setting.• IR signal is blocked.• iPad volume is too low.	<ul style="list-style-type: none">• Make sure the channel selected matches the channel of the Infrared Headphone that you are using.• The wireless IR Headphone must be used within a line of sight from the IR Transmitter.• Turn the iPad volume to maximum.



12 MONTH LIMITED WARRANTY

Applies to Audiovox Mobile Video Products

AUDIOVOX ELECTRONICS CORP. (the Company) warrants to the original retail purchaser of this product that should this product or any part thereof, under normal use and conditions, be proven defective in material or workmanship within 12 months from the date of original purchase, such defect(s) will be repaired or replaced with reconditioned product (at the Company's option) without charge for parts and repair labor. A game controller, if supplied, is similarly warranted for ninety (90) days.

To obtain repair or replacement within the terms of this Warranty, the product is to be delivered with proof of warranty coverage (e.g. dated bill of sale), specification of defect(s), transportation prepaid, to the Company at the address shown below.

This Warranty does not extend to the elimination of externally generated static or noise, to correction of antenna problems, to costs incurred for installation, removal or reinstallation of the product, or to damage to digital memory/media devices, gaming devices, discs, speakers, accessories, or vehicle electrical systems.

This Warranty does not apply to any product or part thereof which, in the opinion of the Company, has suffered or been damaged through alteration, improper installation, mishandling, misuse, neglect, accident, or by removal or defacement of the factory serial number/bar code label(s). THE EXTENT OF THE COMPANY'S LIABILITY UNDER THIS WARRANTY IS LIMITED TO THE REPAIR OR REPLACEMENT PROVIDED ABOVE AND, IN NO EVENT, SHALL THE COMPANY'S LIABILITY EXCEED THE PURCHASE PRICE PAID BY PURCHASER FOR THE PRODUCT.

This Warranty is in lieu of all other express warranties or liabilities. ANY IMPLIED WARRANTIES, INCLUDING ANY IMPLIED WARRANTY OF MERCHANTABILITY, SHALL BE LIMITED TO THE DURATION OF THIS WRITTEN WARRANTY. ANY ACTION FOR BREACH OF ANY WARRANTY HEREUNDER INCLUDING ANY IMPLIED WARRANTY OF MERCHANTABILITY MUST BE BROUGHT WITHIN A PERIOD OF 24 MONTHS FROM DATE OF ORIGINAL PURCHASE. IN NO CASE SHALL THE COMPANY BE LIABLE FOR ANY CONSEQUENTIAL OR INCIDENTAL DAMAGES FOR BREACH OF THIS OR ANY OTHER WARRANTY. No person or representative is authorized to assume for the Company any liability other than expressed herein in connection with the sale of this product.

Some states do not allow limitations on how long an implied warranty lasts or the exclusion or limitation of incidental or consequential damage so the above limitations or exclusions may not apply to you. This Warranty gives you specific legal rights and you may also have other rights which vary from state to state.

Audiovox Electronics Corporation, 150 Marcus Blvd., Hauppauge, New York 11788 1-800-645-4994

128-5495F



For Customer Service
Visit Our Website At
www.audiovoxproducts.com
Product Information, Photos,
FAQ's Owner's Manuals

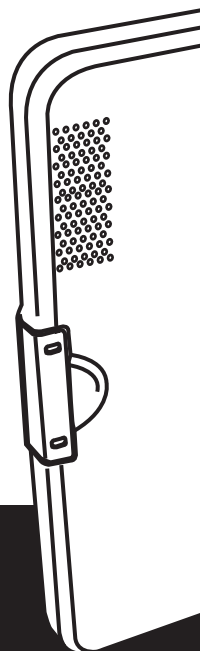

128-9126