

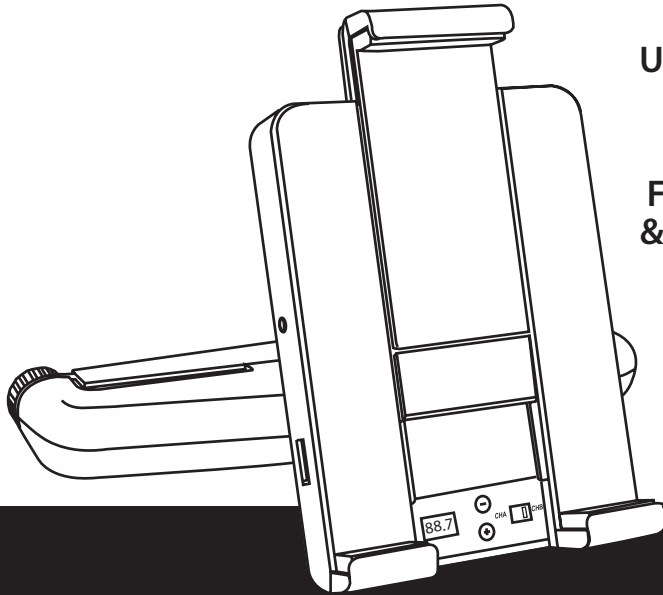

AUDIOVOX



**Universal Tablet
Mounting Kit
with Built-In
FM Transmitter
& IR Transmitter**

IPD-UNV

OWNER'S MANUAL







INTRODUCTION

The IPD-UNV Universal Tablet Mounting Kit is a perfect solution for tablet use in a vehicle. The IPD-UNV allows the user to mount a tablet securely to the back of the driver or passenger seat headrest. Once mounted, the user can position the tablet to maximize viewing pleasure. The IPD-UNV also charges the tablet and offers the user three audio options:

1. Utilize the FM Transmitter to listen to audio from the tablet through the vehicle's speakers.
2. Use an Infrared Headset (sold separately) to listen to audio from the Tablet from through the IPD-UNV IR Transmitter.
3. Use a Bluetooth® Stereo Headset (sold separately) to listen to audio from a Bluetooth® capable tablet.

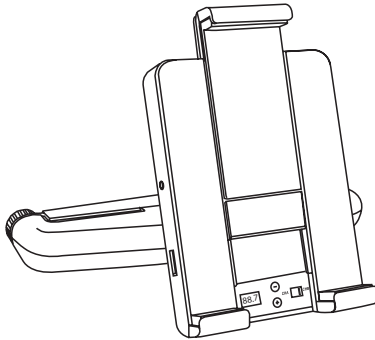



IPD-UNV UNIVERSAL TABLET MOUNTING KIT CONTENTS

PACKAGE INCLUDES:

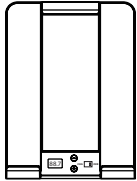

Universal Mount

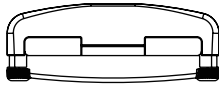

Headrest Mounting Bracket

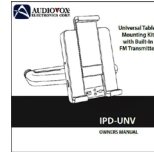

Owner's Manual

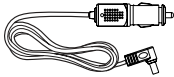

Vehicle Power Adaptor



3.5mm AUX-IN Cable

OPTIONAL ACCESSORIES



Bluetooth Headphones (BT-HP2)

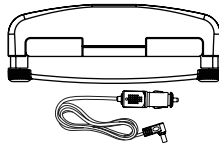

Headrest Mounting Bracket (IPD-VDSC)



Dual Channel Infrared Headphones (MTGHP2CA)



Single Channel Infrared Headphones (MTGHP1CA)

EXTRA HEADREST MOUNTING BRACKET

The Headrest Mounting Bracket can be installed very easily on either the Driver or Passenger seat. If the Universal Mount is to be used in more than one vehicle, a second Headrest Mounting Bracket can be purchased and installed allowing the user to enjoy using a tablet in either vehicle without having to uninstall and reinstall the Headrest Mounting Bracket.





UNIVERSAL MOUNT - FRONT

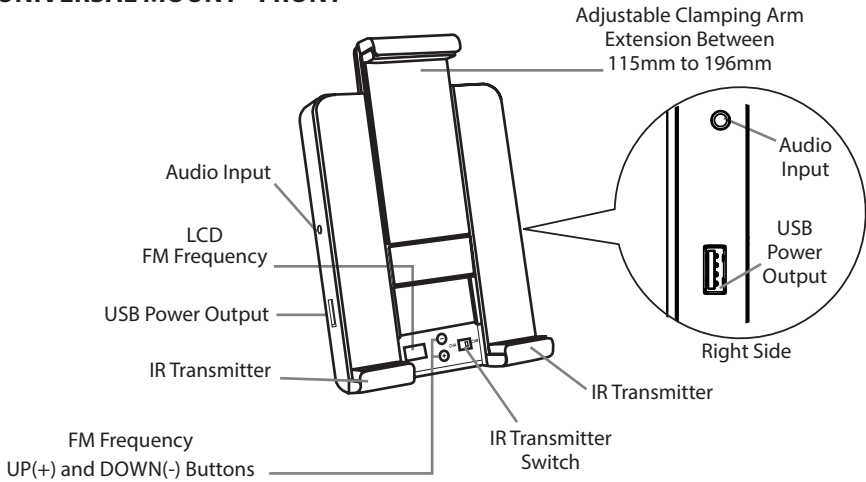

UNIVERSAL MOUNT - BACK

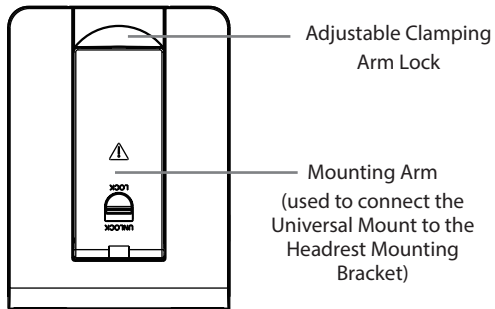



INSTALLING THE HEADREST MOUNTING BRACKET

Step 1: From the back seat of the vehicle, lift the headrest upwards so that it is locked into the highest position.

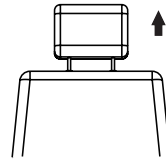

Step 2: Locate the Vehicle Power Adaptor and plug it into the vehicle ACC socket and connect the other end to the Headrest Mounting Bracket power IN connection.

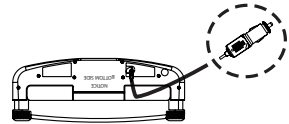

Headrest Mounting Bracket
(Bottom Side View)

Step 3: Remove the bracket locking support bar from the Headrest Mounting Bracket body by removing the two locking screws.

Step 4: Place the Headrest Mounting Bracket body on the rear side of the headrest support posts making sure that the rubber friction surfaces are facing forward.

NOTE: Make sure that the words "BOTTOM SIDE" are facing downward when installing the Headrest Mounting Bracket.

Step 5: Align the screw holes on the bracket locking support bar with the screw holes on the Headrest Mounting Bracket body and loosely reinstall the two locking screws.

Step 6: Adjust the headrest to the desired position and tighten the two locking screws securing the Headrest Mounting Bracket to the headrest.

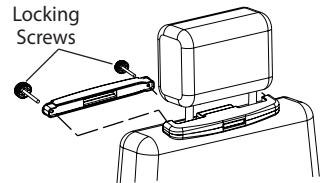



INSTALLING THE UNIVERSAL MOUNT INTO HEADREST MOUNTING BRACKET

Step 1: Open the Mounting Arm on the back of the Universal Mount.

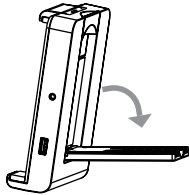

Step 2: While holding the “Grey Switch”, located on the bottom side of the Mounting Arm in the UNLOCK position, insert the Universal Mount into the Headrest Mounting Bracket, as indicated in the figure below.

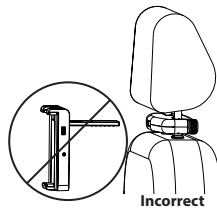
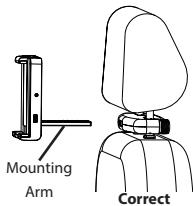

Step 3: When the Mounting Arm is fully inserted into the Headrest Mounting Bracket, release the “Grey Switch” to the LOCK position.

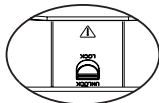

First LOCK-IN position

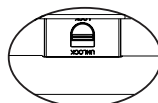

Full LOCK-IN position



Note: Ensure that the Mounting Arm is inserted properly with the Mounting Arm fully inserted and locked inside the Headrest Mounting Bracket before the vehicle is in motion.





INSTALLING A TABLET ONTO THE UNIVERSAL MOUNT

Step 1: Open the Arm Lock on the back of the Universal Mount.

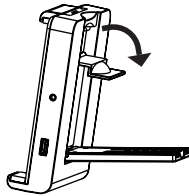

Step 2: Lift the Adjustable Clamping Arm up to the maximum height.

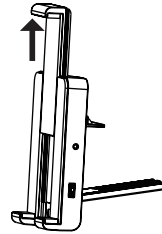

Step 3: Position a tablet in the Universal Mount.

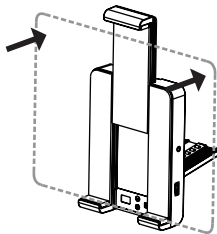

Step 4: Push the Adjustable Clamping Arm downward to compress the foam rubber so that the Upper and Lower lips secure the tablet.

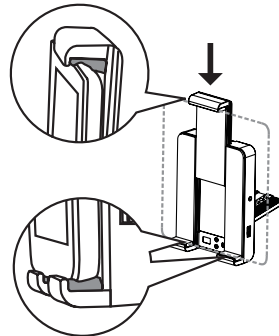



INSTALLING A TABLET ONTO THE UNIVERSAL MOUNT (Continued)

Step 5: While applying downward pressure to the Adjustable Clamping Arm, close the Arm Lock. Ensure that the tablet is fully secured into the Universal Mount.

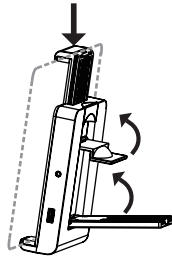

NOTE: *Adjust the tilting angle of the mounted tablet to the desired position to avoid glare.*

REMOVING A TABLET FROM THE UNIVERSAL MOUNT

Step 1: Open the Arm Lock on the back of the Universal Mount.

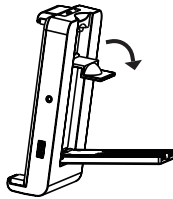

Step 2: While holding the tablet, lift the Adjustable Clamping Arm up and remove the tablet.

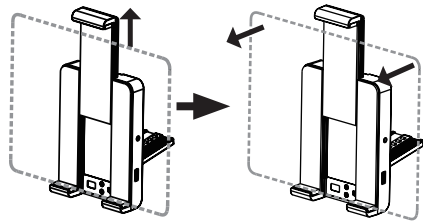



CHARGING A TABLET ON THE UNIVERSAL MOUNT

Step 1: Connect the USB Power Cable that was provided with the tablet into the required connector on the tablet.

Step 2: Connect the USB Power Cable into a USB port on either side of the Universal Mount.

NOTE: *The Universal Mount has two (2) USB outputs that allow a tablet to charge. If a device is plugged into each USB connector, only one connector will support up to 2 Amp charging, while the second will support up to 1 Amp charging. The first device that is plugged in will charge at up to 2 Amps.*

CONNECTING THE AUDIO SIGNAL FROM THE TABLET TO THE UNIVERSAL MOUNT (IR TRANSMITTER / FM TRANSMITTER)

Using the supplied 3.5mm AUX-IN Cable, connect one end of the cable into the tablet's headphone jack and the other end of the cable into the 3.5mm jack on either side of the Universal Mount.

NOTE: *The FM transmitter and IR functions are activated when the 3.5mm cable is connected to the Universal Mount and will begin to transmit the FM and IR signals when the tablet is connected.*

IR TRANSMISSION MODE

Step 1: Select either "CH A" or "CH B" on the Universal Mount.

Step 2: Turn the single or dual channel Infrared Headphones (sold separately) Power ON, the power indicator will illuminate red.

Step 3: Adjust the volume level with the volume control wheel to its lowest setting before putting the Infrared Headphones on.

Step 4: Select either "CH A" or "CH B" to correspond to the transmitted signal being received.

NOTE: *If single channel Infrared Headphones (sold separately) are used, "CH A" should be selected on the Universal Mount.*

NOTE: *If two Universal Mounts are used in the same vehicle, set one Universal Mount to "CH A" and the other Universal Mount to "CH B". Set the headphones to their respective channels.*

To ensure good signal reception, refer to the following guidelines:

- Line of sight facing the "IR Transmitter" (Ideal performance for line of sight is within 5 meters).





FM TRANSMISSION MODE

The built-in wireless FM Transmitter can be used to listen to audio from the tablet through the vehicle audio speakers.

NOTE: *The tablets must be removed to set the FM Transmitter or IR Transmitter settings.*

Step 1: Tune the vehicle radio to an unused frequency.

Step 2: Using the FM Frequency Up(+) and Down(-) Buttons on the Universal Mount, set the FM Frequency to the same FM Frequency on the vehicle stereo.

Step 3: Secure the tablet onto the Universal Mount. (See pages 8 and 9)

Step 4: Insert one end of the 3.5 mm AUX-IN cable into the Universal Mount and the other end into the tablet's headphone jack. The FM and IR functions will be activated and will begin to transmit the FM and IR signals instantly.

The user can turn the FM Transmitter ON and OFF by pressing FM Frequency Up(+) and Down(-) Buttons at the same time. The selected FM Frequency is recalled the next time the FM Transmitter is turned ON.

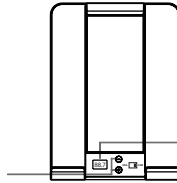

When the tablet is mounted and connected to the Universal Mount, the LCD screen will display the current FM Frequency setting when power is applied.

DISABLING THE FM AND IR TRANSMISSION

The user can choose to listen to audio through the tablet's speakers while utilizing the Universal Mount to hold the tablet and supply Power.

To listen to audio through the tablet's built in speakers, disconnect the 3.5mm AUX-IN Cable from the headphone jack.





TROUBLESHOOTING:

Problem	Cause	Solution
Tablet does not charge	Power supply is not connected.	<ul style="list-style-type: none">• Connect the Vehicle Power Adaptor.• Connect the USB Cable.
FM transmitter does not work	<ul style="list-style-type: none">• Incorrect frequency settings.• The AUX-IN Cable is not connected.• The FM Transmitter is OFF.	<ul style="list-style-type: none">• Make sure the frequency shown on the Universal Mount LCD display is the same as what the vehicle Radio is tuned to.• Make sure the 3.5mm cable is connected.• Turn the FM Transmitter ON.
Mounting Arm does not fit into the Headrest Mount.	<ul style="list-style-type: none">• The "Unlock" key has not pressed when trying to insert the Mounting Arm into the Headrest Mount.• The Universal Headrest Mount installed upside down.• The Universal Mounting Bracket is upside down.	Follow appropriate steps to reinstall.
IR transmitter does not work.	<ul style="list-style-type: none">• Power is not connected.• 3.5mm AUX-IN Cable not connected.• IR Headphones batteries are discharged.• IR Transmitter Switch set incorrectly	<ul style="list-style-type: none">• Connect the Vehicle Power Adaptor.• Connect the 3.5mm AUX-IN Cable.• Replace IR Headphone batteries.• Verify correct IRT Channel settings.





WARRANTY



12 MONTH LIMITED WARRANTY

Applies to Audiovox Mobile Video Products

VOXX ELECTRONICS CORP. (the Company) warrants to the original retail purchaser of this product that should this product or any part thereof, under normal use and conditions, be proven defective in material or workmanship within 12 months from the date of original purchase, such defect(s) will be repaired or replaced with reconditioned product (at the Company's option) without charge for parts and repair labor. A game controller, if supplied, is similarly warranted for ninety (90) days.

To obtain repair or replacement within the terms of this Warranty, the product is to be delivered with proof of warranty coverage (e.g. dated bill of sale), specification of defect(s), transportation prepaid, to the Company at the address shown below.

This Warranty does not extend to the elimination of externally generated static or noise, to correction of antenna problems, to costs incurred for installation, removal or reinstallation of the product, or to damage to digital memory/media devices, gaming devices, discs, speakers, accessories, or vehicle electrical systems.

This Warranty does not apply to any product or part thereof which, in the opinion of the Company, has suffered or been damaged through alteration, improper installation, mishandling, misuse, neglect, accident, or by removal or defacement of the factory serial number/bar code label(s). THE EXTENT OF THE COMPANY'S LIABILITY UNDER THIS WARRANTY IS LIMITED TO THE REPAIR OR REPLACEMENT PROVIDED ABOVE AND, IN NO EVENT, SHALL THE COMPANY'S LIABILITY EXCEED THE PURCHASE PRICE PAID BY PURCHASER FOR THE PRODUCT.

This Warranty is in lieu of all other express warranties or liabilities. ANY IMPLIED WARRANTIES, INCLUDING ANY IMPLIED WARRANTY OF MERCHANTABILITY, SHALL BE LIMITED TO THE DURATION OF THIS WRITTEN WARRANTY. ANY ACTION FOR BREACH OF ANY WARRANTY HEREUNDER INCLUDING ANY IMPLIED WARRANTY OF MERCHANTABILITY MUST BE BROUGHT WITHIN A PERIOD OF 24 MONTHS FROM DATE OF ORIGINAL PURCHASE. IN NO CASE SHALL THE COMPANY BE LIABLE FOR ANY CONSEQUENTIAL OR INCIDENTAL DAMAGES FOR BREACH OF THIS OR ANY OTHER WARRANTY. No person or representative is authorized to assume for the Company any liability other than expressed herein in connection with the sale of this product.

Some states do not allow limitations on how long an implied warranty lasts or the exclusion or limitation of incidental or consequential damage so the above limitations or exclusions may not apply to you. This Warranty gives you specific legal rights and you may also have other rights which vary from state to state.

VOXX Electronics Corporation, 150 Marcus Blvd., Hauppauge, New York 11788 • 1-800-645-4994

128-9330





NOTES:







For Customer Service
Visit Our Website At
www.voxxelectronics.com
Product Information, Photos,
FAQ's, Owner's Manuals

© 2014 VOXX ELECTRONICS CORP., 150 MARCUS BLVD., HAUPPAUGE, NY 11788



128-9266

