

Power Series Amplifiers Installation Manual / Quick Start Guide

JENSEN®

Installation Assistance

For installation assistance, call 888-921-4088 during normal business hours, or visit www.jensenmobile.com at any time.

Supplies and Tools

To install the amplifier, you will need tools, supplies and adapters. It is best to make sure you have everything you need before you start.

Disconnect Battery

Disconnect the negative (-) battery cable before starting the installation. Check the battery ground (there should be two (2) ground wires coming from the battery – one going to the starter mounting bolt or engine block and another going to the vehicle chassis) and make sure the battery is grounded to the chassis with at least a #8 gauge wire. Also check the alternator connections, making sure they are tight and free from corrosion, rust or dirt.

Location and Mounting

The amplifier's compact design allows great flexibility in mounting. Common mounting locations include under the front passenger seat or in the trunk area.

When selecting a location, remember that amplifiers generate heat. Select a location on a flat surface away from heat and moisture where air can circulate around the amplifier.

Recommended Power Wire Size

MODEL NUMBER	FUSE SIZE	MIN. WIRE GAUGE
Power250x2	25A	#8
Power400x4	2x20A	#8
Power500x1	2x35A	#6

Remote Terminal (Turn-On)

Connect the power antenna or amplifier turn-on lead (Switched +12VDC) from the receiver to the amplifier remote terminal.

Note: Complete amplifier operation manuals are online at www.jensenmobile.com

Power Terminal (+12V) and Ground Terminal (Gnd)

Connect the main power wire to the battery, within 18 inches from the positive (+) battery post, use an adequate size fuse or circuit breaker capable of handling the current of the selected power wire. A fuse or circuit breaker must be installed to prevent a possible electrical fire should the main power wire short to ground.

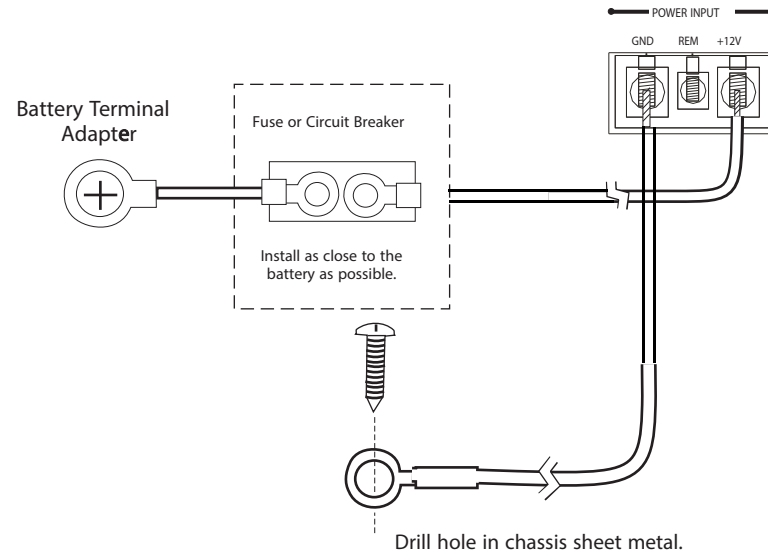

Make the ground lead as short as possible, leaving enough length to complete the installation. To ensure a good ground, scrape away any paint or undercoating to expose bare metal. Use a "ring" terminal of the proper gauge and an "outside star washer" (between the chassis and ring terminal) when making your ground connection.

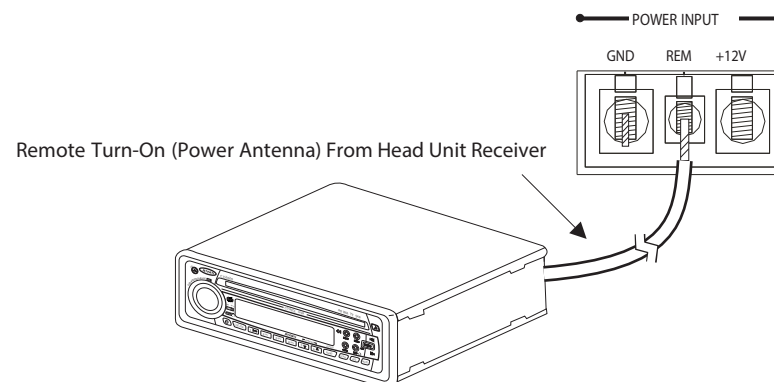

Speaker Wiring

The Speaker Wiring diagrams illustrate options for connecting one or two speakers. Observe the proper speaker polarity.

Power500x1

Two Subwoofers

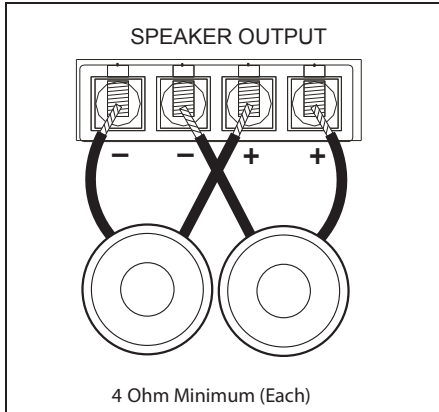

One Subwoofer

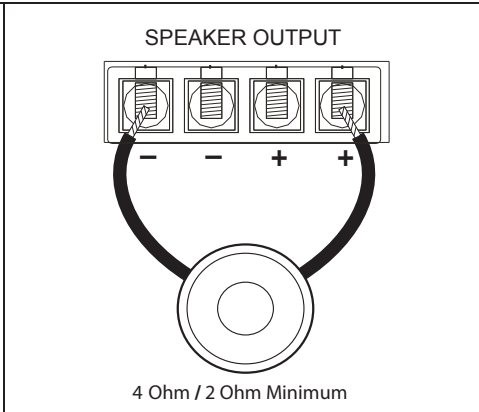

Power250x2

Two Speakers

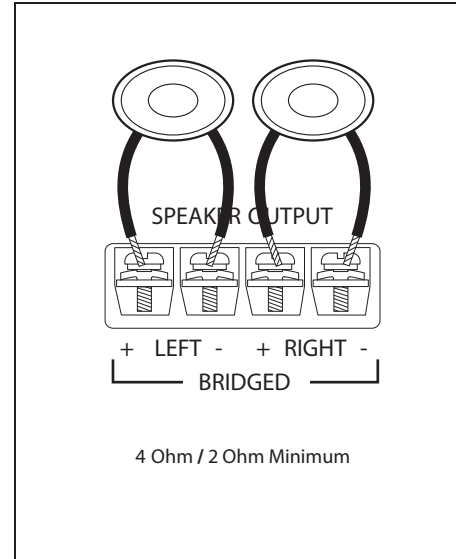

One Subwoofer

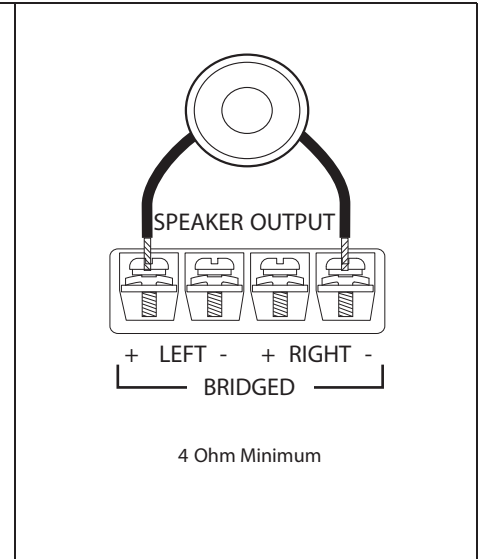

Power400x4

Four Speakers

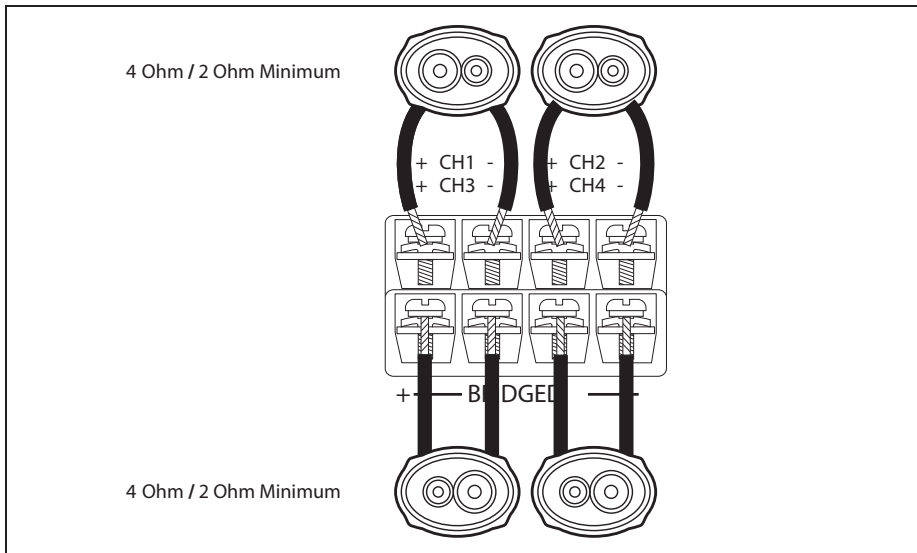

Power400x4

Two Speakers

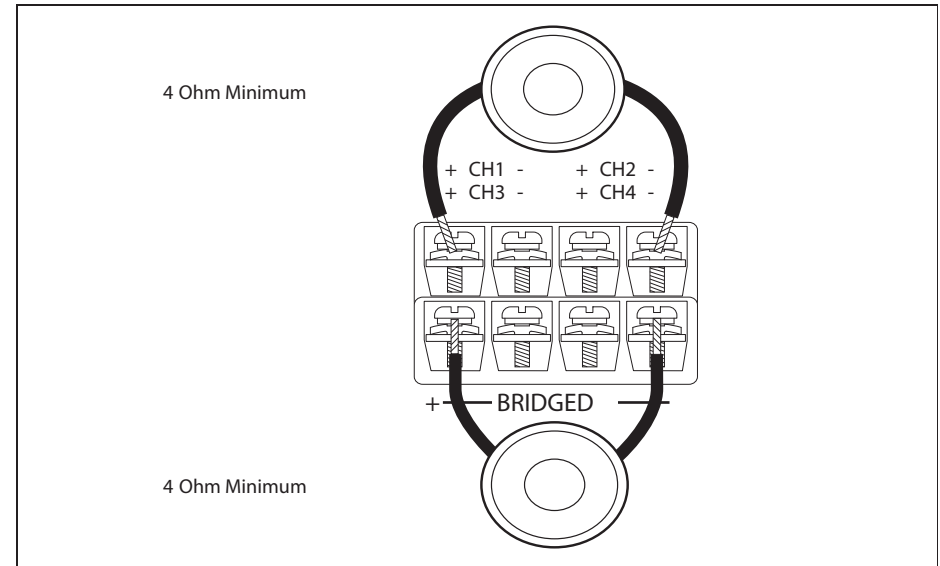

Input Wiring

Most trunk/hatchback installations will require a 15-20 foot RCA cable, while pickup trucks and under-seat mounting will require a 6-12 foot RCA cable. Connect an RCA cable from your receiver to the RCA input on your amplifier.

Power250x2

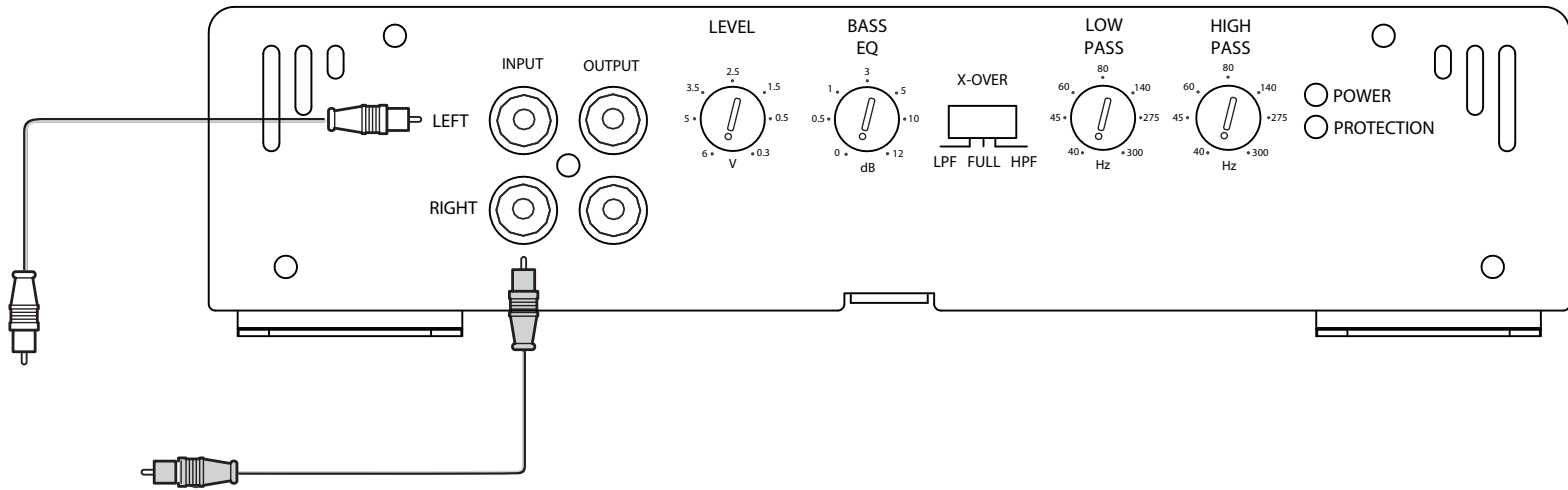

Power400x4

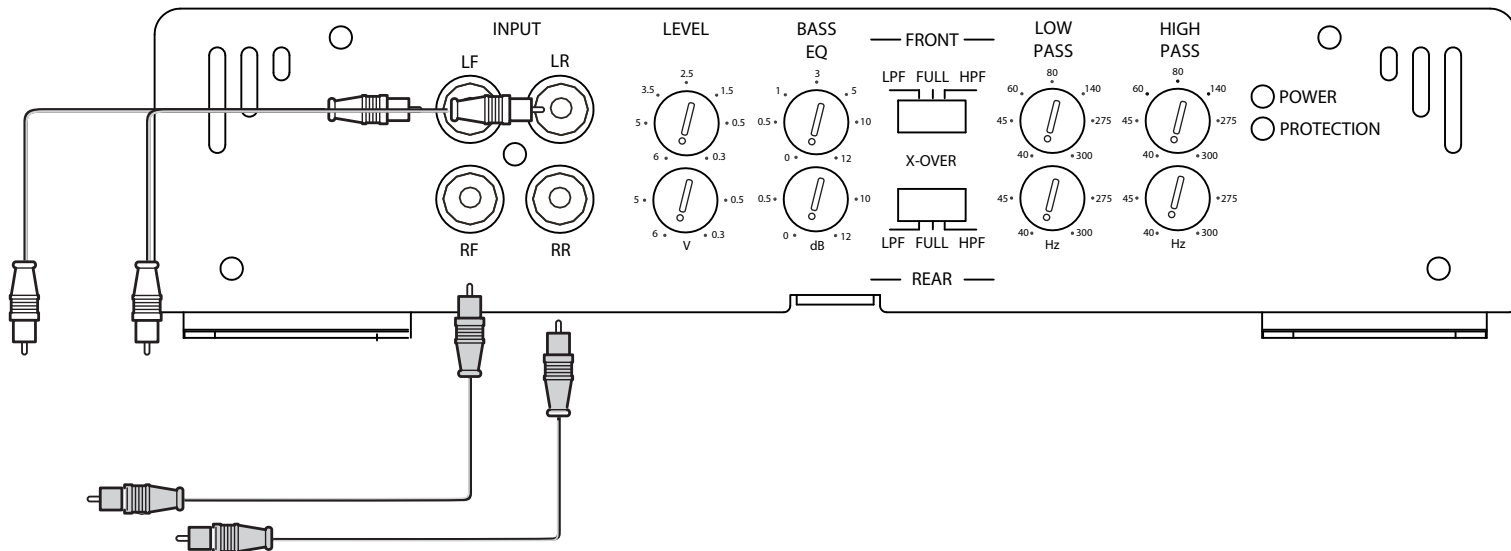

Input Wiring (Continued)

Most trunk/hatchback installations will require a 15-20 foot RCA cable, while pickup trucks and under-seat mounting will require a 6-12 foot RCA cable. Connect an RCA cable from your receiver to the RCA input on your amplifier.

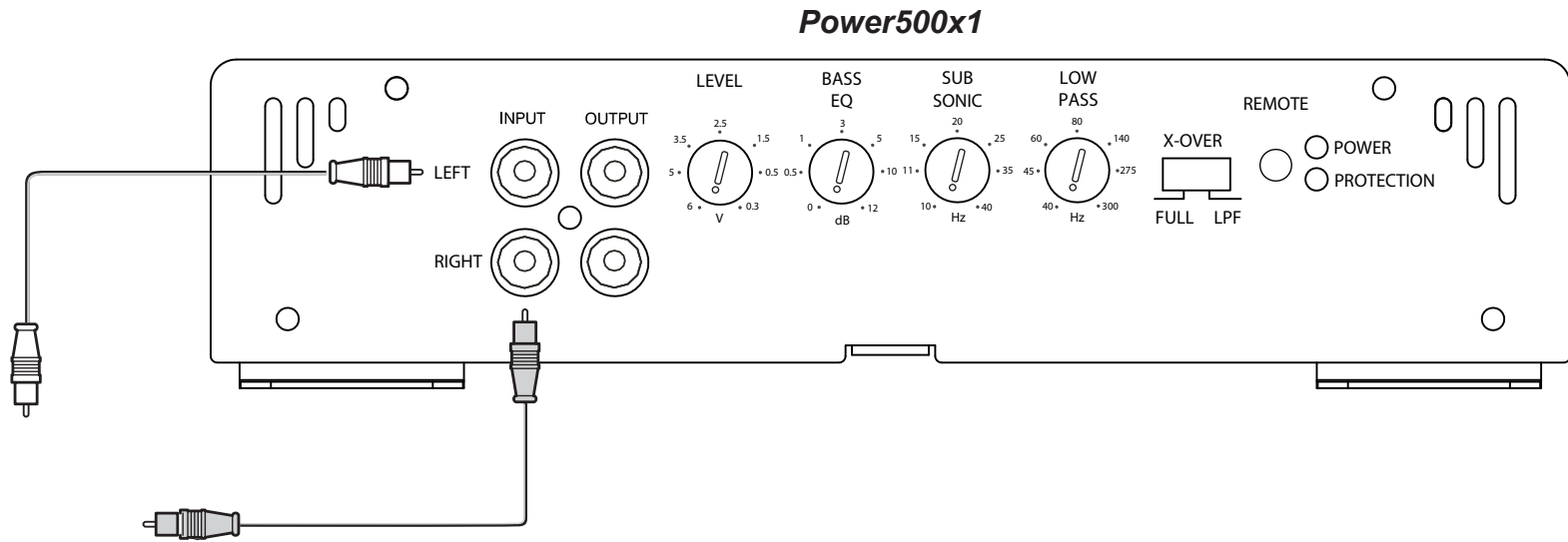

Limited One Year Warranty

This warranty gives you specific legal rights. You may also have other rights which vary from state to state.

Dual Electronics Corp. warrants this product to the original purchaser to be free from defects in material and workmanship for a period of one year from the date of the original purchase.

Dual Electronics Corp. agrees, at our option, during the warranty period, to repair any defect in material or workmanship or to furnish an equal new, renewed or comparable product (whichever is deemed necessary) in exchange without charges, subject to verification of the defect or malfunction and proof of the date of purchase. Subsequent replacement products are warranted for the balance of the original warranty period.

Who is covered? This warranty is extended to the original retail purchaser for products purchased from an authorized Jensen dealer and used in the U.S.A.

What is covered? This warranty covers all defects in material and workmanship in this product. The following are not covered: software, installation/removal costs, damage resulting from accident, misuse, abuse, neglect, product modification, improper installation, incorrect line voltage, unauthorized repair or failure to follow instructions supplied with the product, or damage occurring during return shipment of the product. Specific license conditions and copyright notices for the software can be found via www.jensenmobile.com.

What to do?

1. Before you call for service, check the troubleshooting guide in your owner's manual. A slight adjustment of any custom controls may save you a service call.
2. If you require service during the warranty period, you must carefully pack the product (preferably in the original package) and ship it by prepaid transportation with a copy of the original receipt from the retailer to an authorized service center.
3. Please describe your problem in writing and include your name, a return UPS shipping address (P.O. Box not acceptable), and a daytime phone number with your shipment.
4. For more information and for the location of the nearest authorized service center please contact us by one of the following methods:
 - Call us toll-free at 1-888-921-4088
 - E-mail us at cs@dualav.com

Exclusion of Certain Damages: This warranty is exclusive and in lieu of any and all other warranties, expressed or implied, including without limitation the implied warranties of merchantability and fitness for a particular purpose and any obligation, liability, right, claim or remedy in contract or tort, whether or not arising from the company's negligence, actual or imputed. No person or representative is authorized to assume, for the company, any other liability in connection with the sale of this product. In no event shall the company be liable for indirect, incidental or consequential damages.

Dual Electronics Corporation Heathrow, FL 32746

Technical Assistance: 888-921-4088

www.jensenmobile.com © 2016 Printed in China