

Installation Manual: Nissan Rogue Power Lift Gate System

NOTE: Not for Rogue Sport Models

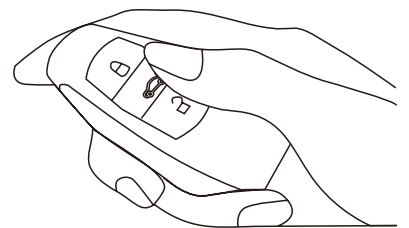
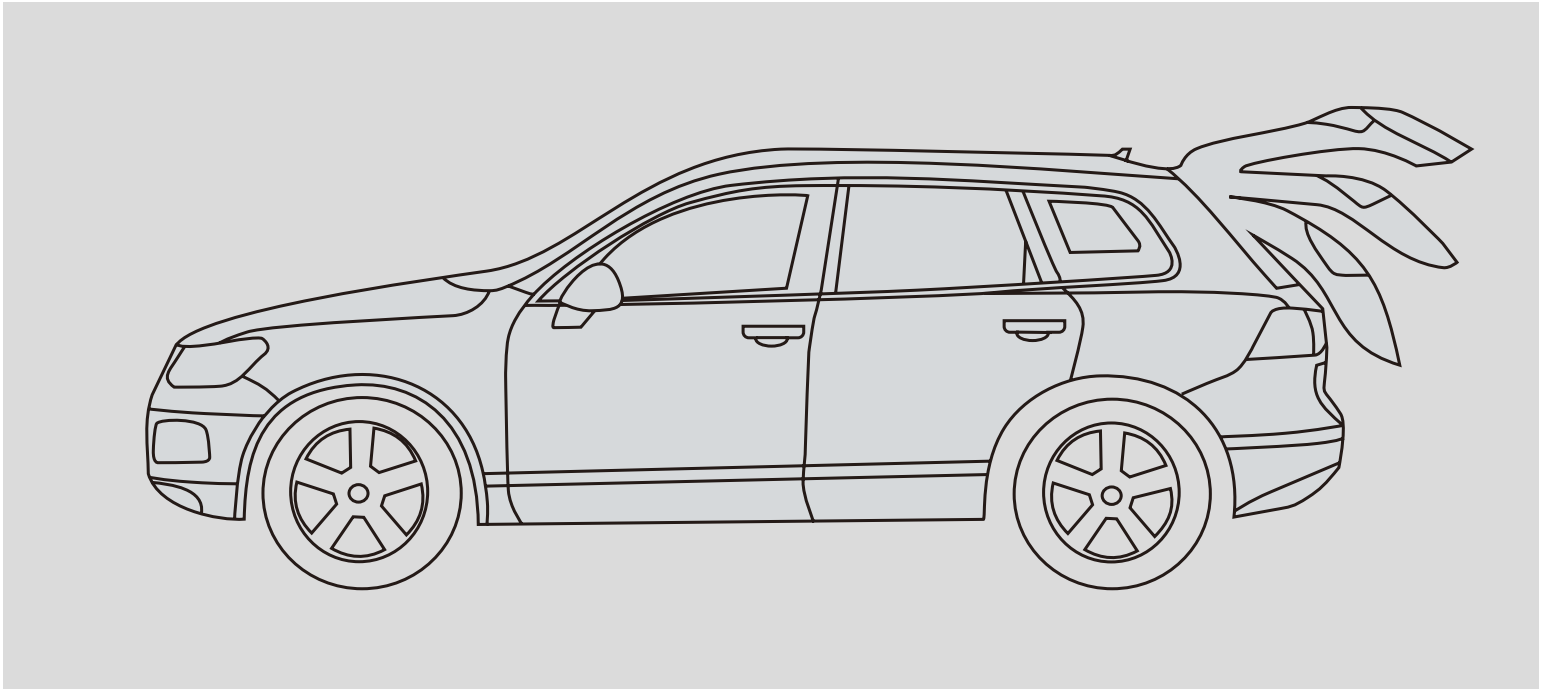

NOTE: Installation Precaution

1. It is recommended to have this product installed by a professional to avoid damage caused by improper installation.
2. Do not attempt to disassemble or modify any components included within the kit. Unapproved modifications or evidence of tampering will void any warranty included with the product.
3. Before installation, inspect the vehicle's controls and interior/exterior for any damage or malfunctioning components. Report any damage or non conformities to the customer prior to installing the product.
4. Inspect the factory lift gate for proper operation and function of lights before installing this product. Improper opening or closing of the lift gate may interfere with the functionality of the Power Lift Gate System.
5. It is recommended to remove or cover any item of clothing (belt buckles, jeans rivets, buttons, etc) prior to installation of this accessory to prevent damage incurred to the vehicle during the installation.
6. Interior panels that have been removed should be set aside somewhere safe during the installation process to avoid damage.
7. When routing and securing wiring harnesses, care should be exercised to avoid any hot, sharp, or moving objects in the vehicle such as steering column, pedals, dash bracing, HVAC components, etc.
8. Do not deviate from methods of installation in this document. Any damage caused by improper wire routing, incorrect connections, wiring, etc. is not covered under the warranty.
9. Disconnect the negative (-) battery terminal before proceeding to installation. Wait at least 2 minutes after disconnecting the negative (-) battery terminal to disable the SRS and other systems in the vehicle. Any damage caused from failure to disconnect the battery is not covered under the warranty.
10. After installation, you must manually close the lift gate to initialize the Power Lift Gate System.

Wiring Details

ADVENT[®] NR Liftgate System Layout

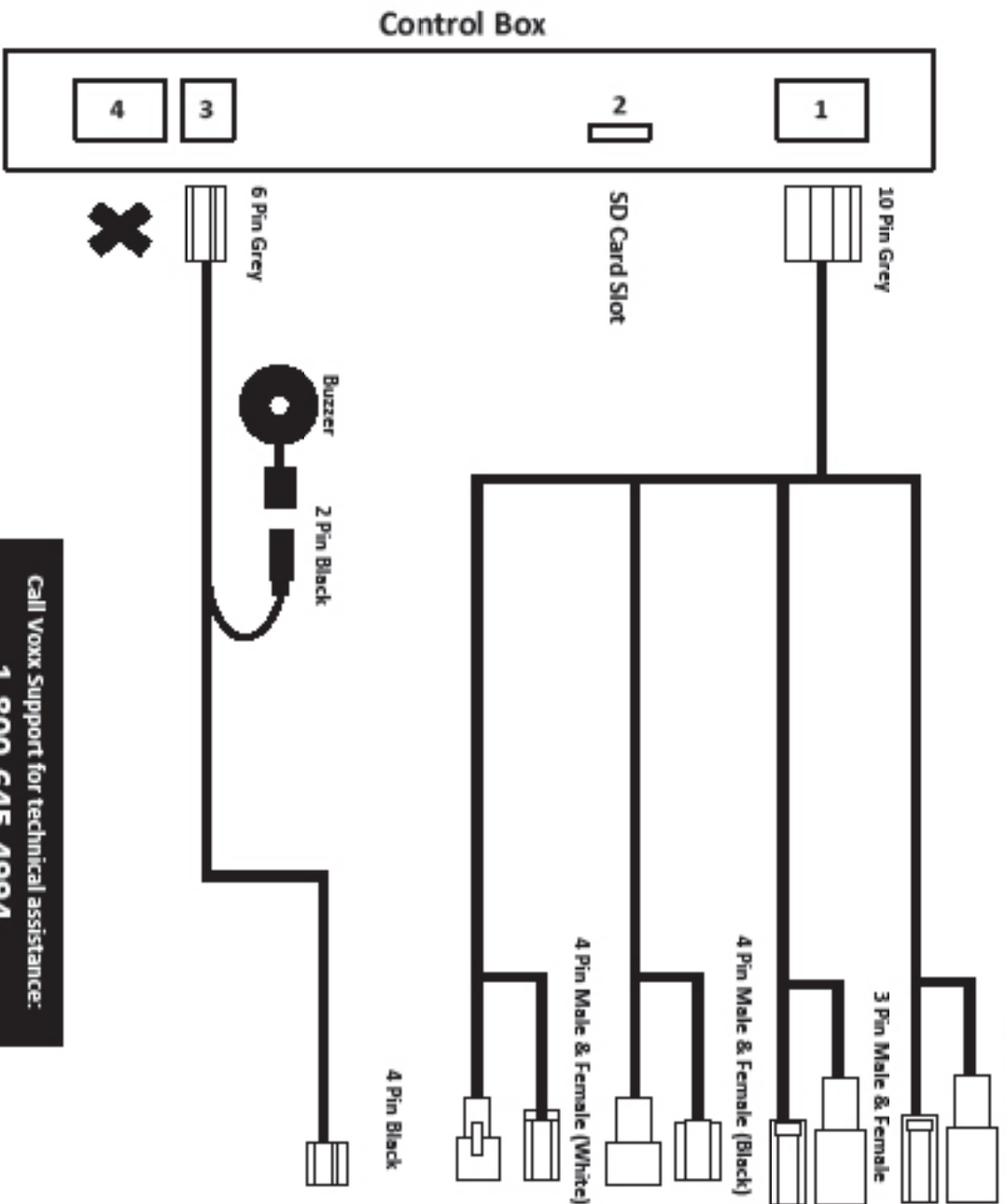

Call Voxx Support for technical assistance:
1-800-645-4994
 9 AM – 6 PM (EST - Eastern) Monday – Friday

- ① Left Liftgate Connection
 - ② Right Liftgate Connection
 - ③ Electronic Locking Mechanism
 - ④ Outside Latch Button
 - ⑤ Back Button
- NOTE: Remove factory cover to install button
- Component Locator
-

Wiring Details

ADVANTAGE

NR Liftgate System Layout

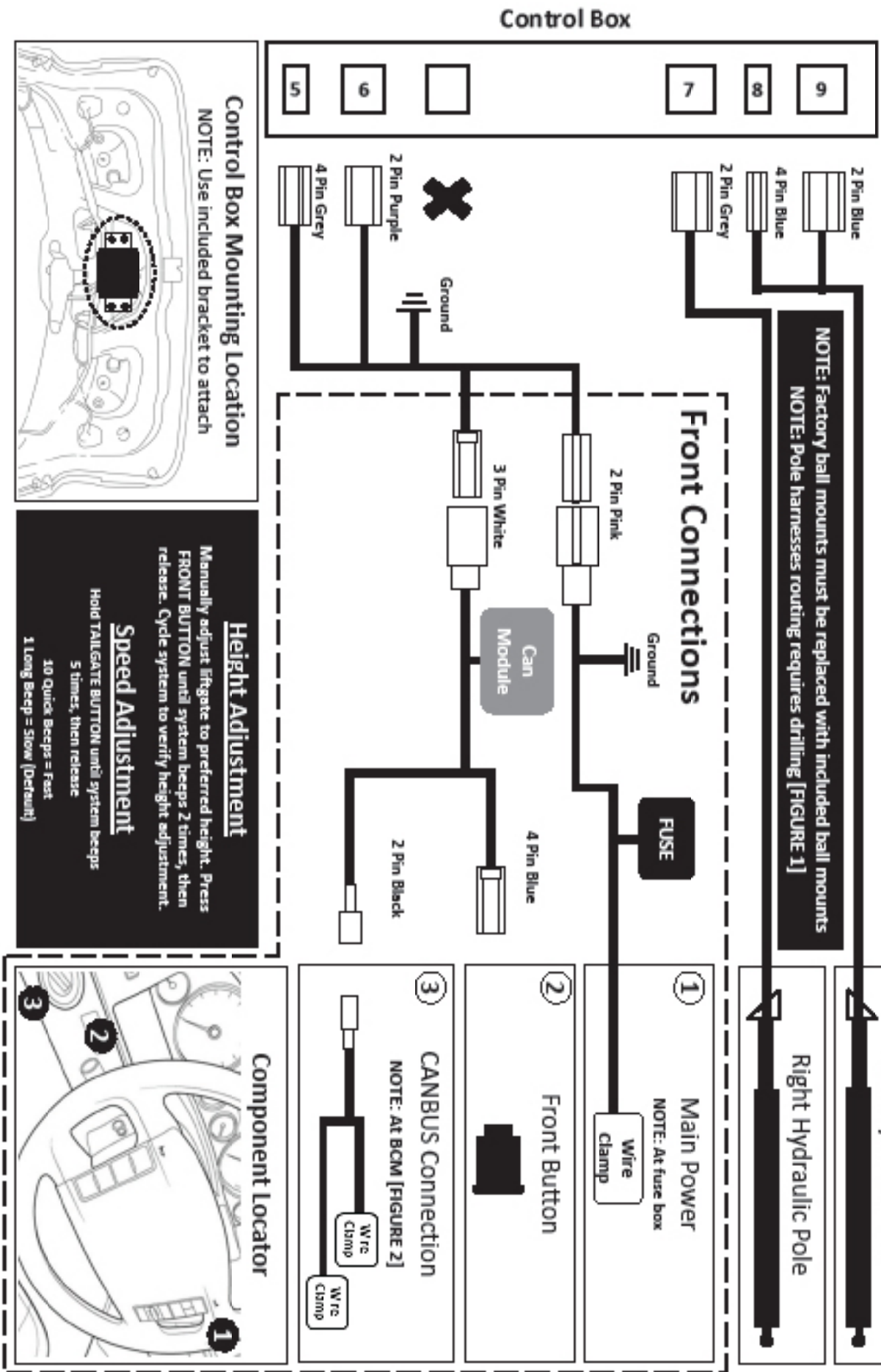

NOTE: Factory ball mounts must be replaced with included ball mounts
NOTE: Pole harnesses routing requires drilling. [FIGURE 1]

Control Box Mounting Location
NOTE: Use included bracket to attach

Height Adjustment
 Manually adjust liftgate to preferred height. Press FRONT BUTTON until system beeps 2 times, then release. Cycle system to verify height adjustment.

Speed Adjustment
 Hold TRAILGATE BUTTON until system beeps 5 times, then release
 10 Quick Beeps = Fast
 1 Long Beep = Slow (Default)

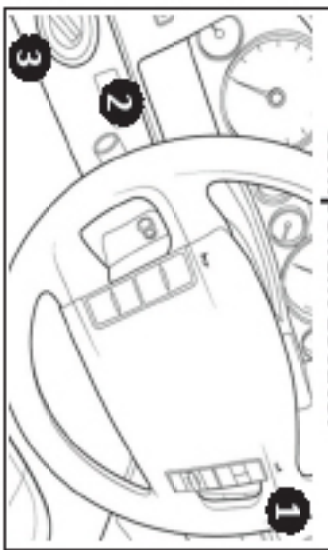
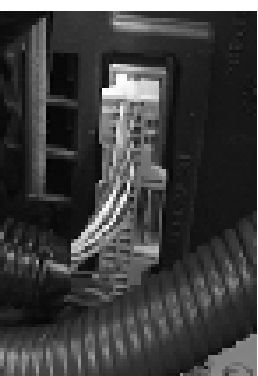
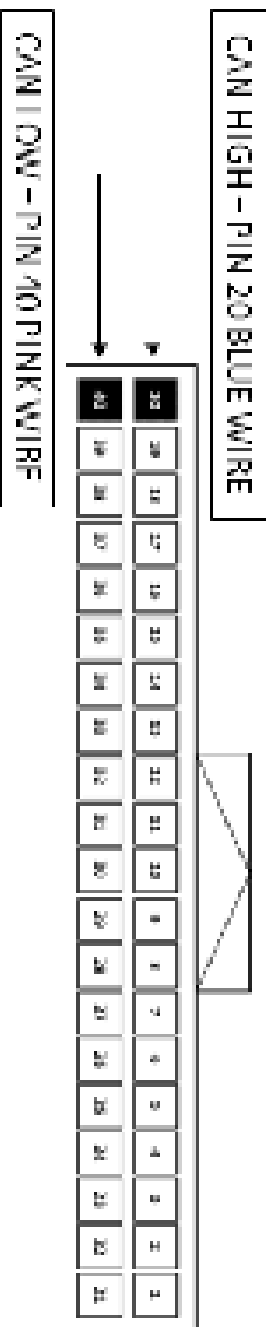

FIGURE 1: Pole Harness Drill Location



FIGURE 2: CANBUS Connection

1. Connect CANBUS Harness's GRN Wire to BCM Pin 20 (Blue)
2. Connect CANBUS Harness's GRN/BLACK wire to BCM Pin 40 (Pink)



PREPARING FOR INSTALLATION

INSTALLATION PREPARATION

Before starting installation

1. Familiarize yourself with the installation instructions.
2. Inspect kit components to verify everything is present, there is no damage, and to familiarize yourself with the parts.

VEHICLE PREPARATION

1. Place protective coverings on vehicle.
2. Apply protective tape to all points before prying.

3. **"IMPORTANT.....IMPORTANT"**



Disconnect Negative Battery Cable

INSTALLATION:

1. Disengage the clips and remove the driver's dash side cover panel.
2. Remove the screws securing the driver's lower dash panel.

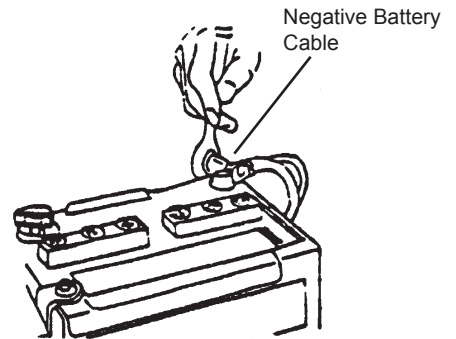

3. Carefully pull on the driver's lower dash panel to disengage the clips. Disconnect any connectors and remove the driver's lower dash panel.



4. Remove the 3 screws that secure the control buttons to the driver's lower dash panel, and remove the button panel.



5. Remove the blank knock out and install the supplied lift gate open/close button into the button panel. Then reinstall the button panel to the driver's lower dash panel with the 3 screws, previously removed.



6. Connect the Power Lift Gate's power wire to the red wire at the rear of the fuse panel with the supplied connector clamp.

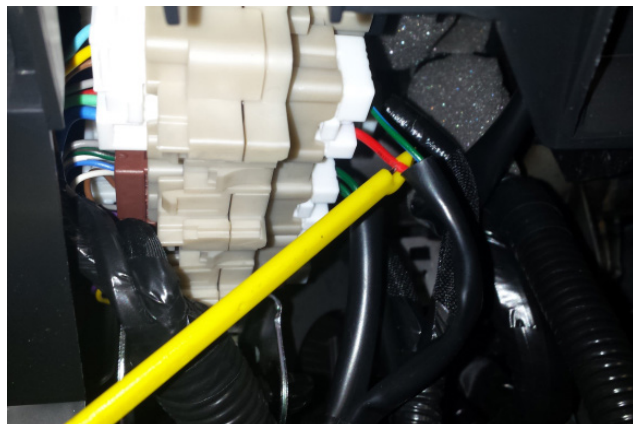

7. Make CAN-Bus connections as shown in the diagram on page 5.

8. Route the Power Lift Gate's wiring harness towards the rear of the vehicle.



9. Route the harness towards the liftgate opening. Loosen the weatherstrip and pull the harness out.



10. Loosen both sides of the wiring harness boot between the vehicle's body structure and the lift gate.

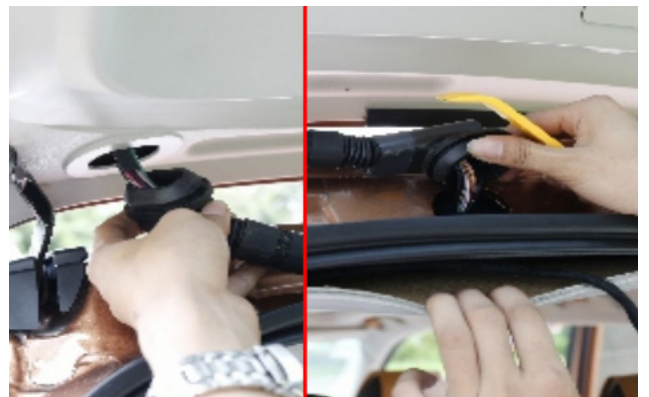

11. Using a wire puller or fish tape, carefully pull the wire harness through the wiring boot.

Note: Spraying a bit of soap/water solution inside the wiring boot will help to lubricate the rubber boot and make it easier to pull the harness through.



12. Carefully disengage the clips and remove the lift gate interior trim panel.



13. Using the wire puller or fish tape, route the wiring harness through the sides and into the lift gate structure as pictured.



14. Mount the supplied control module mounting bracket in the lift gate structure, as shown.

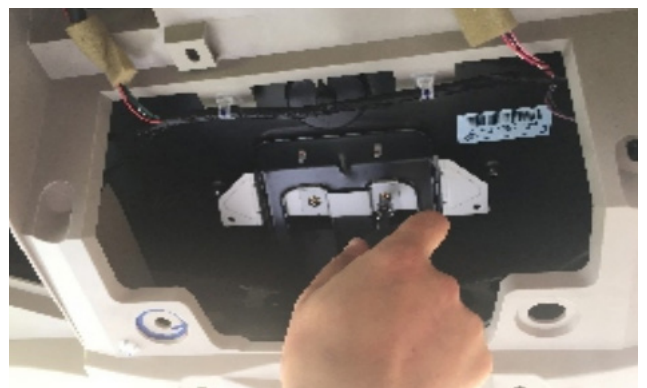

15. Mount the control module to the mounting bracket.

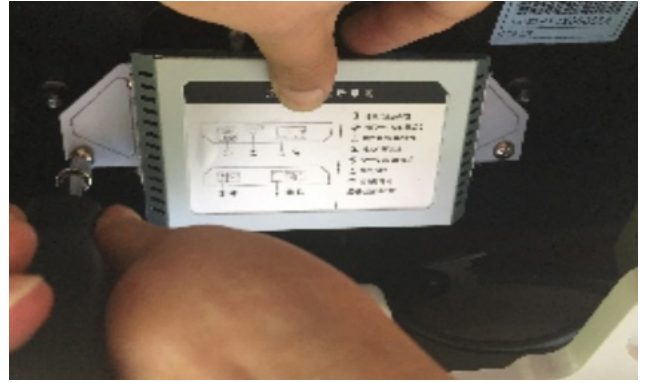

16. Using a helper or supporting brace, support the lift gate in the full opened position.

17. Using a pry tool, remove the lower clip on the end of the OEM gas support struts for the lift gate.



Exercise caution when removing the support struts, as the lift gate is very heavy once removed.

18. Using a pry tool, remove the upper clip on the end of the OEM gas support strut for the lift gate, and remove the support strut.



19. Repeat for the opposite side.

20. Remove the OEM strut ball mounts from both sides of the lift gate. Replace with the ball mounts supplied in the kit.

21. Remove the OEM lower support strut brackets from the body structure. Replace with the new brackets supplied in the kit.



Note: Transfer the gasket from the OEM bracket to the new bracket before installing.

22. Install the Power Lift Gate Lift Motors onto the ball mounts with the wire harness facing upwards, on the lift gate side. Note the LEFT and RIGHT orientation as marked on the lift motors.



23. You will need to drill a hole in the plastic for the wire harness from the lift motor to pass through.



24. Disconnect the OEM lift motor's wiring harness and connect to the power lift motor's wiring harness you just installed.

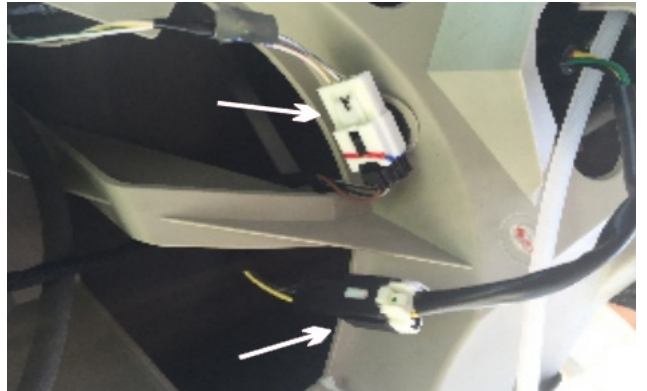

25. Disconnect the OEM power latch motor connector, and connect to supplied T-Harness.

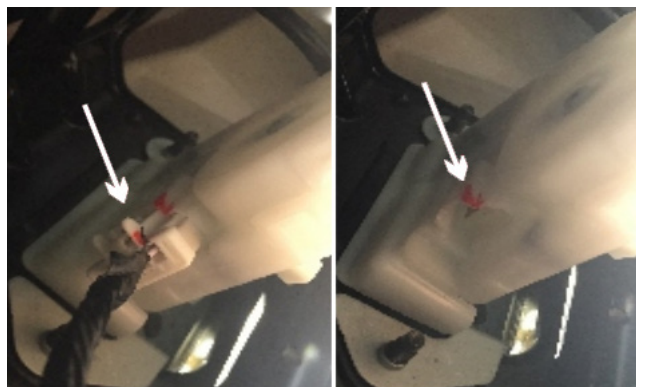

26. Remove the OEM open/close button cover plate. Install the supplied open/close button.



27. Connect the harness to the button, and make all appropriate connections to the main control module.



28. Reinstall all of the interior panels removed during the installation.



29. **IMPORTANT:** Prior to closing, ensure door panel is re-installed. Manually close the lift gate to initialize the Power Lift Gate System. Function test the system to verify proper operation.

THESE POINTS MUST BE CHECKED TO ENSURE A QUALITY INSTALLATION

- | | |
|--|--|
| <input type="checkbox"/> Head Light
<i>If the warning lights remains on, it may indicate a system malfunction.</i> | <input type="checkbox"/> Massage Seats (if equipped) |
| <input type="checkbox"/> High Beams | <input type="checkbox"/> Power Side Mirrors (if equipped) |
| <input type="checkbox"/> Turn Signal Lights | <input type="checkbox"/> Side Mirror Defogger (if equipped) |
| <input type="checkbox"/> Tail Lights | <input type="checkbox"/> Front Windshield Defogger (if equipped) |
| <input type="checkbox"/> Stop Lights | <input type="checkbox"/> Navigation System (if equipped) |
| <input type="checkbox"/> Backup Lights | <input type="checkbox"/> Rear Sunshade (if equipped) |
| <input type="checkbox"/> Hazard Lights | <input type="checkbox"/> Cruise Control Light (if equipped) |
| <input type="checkbox"/> Marker Lights | <input type="checkbox"/> Steering Wheel Audio Control (if equipped) |
| <input type="checkbox"/> Dome/Courtesy Lights | <input type="checkbox"/> HVAC |
| <input type="checkbox"/> Panel/Switch Illumination | <input type="checkbox"/> Power Locks (if equipped) |
| <input type="checkbox"/> Accessory Controls/Illumination (if equipped) | <input type="checkbox"/> Power Windows (if equipped) |
| <input type="checkbox"/> Rear Window Defogger (if equipped) | <input type="checkbox"/> Gauges |
| <input type="checkbox"/> Key Sensor Buzzer | <input type="checkbox"/> Front Wiper/Washer |
| <input type="checkbox"/> Fog Lights (if equipped) | <input type="checkbox"/> Hood Latch Release |
| <input type="checkbox"/> Day Time Running Lights (if equipped) | <input type="checkbox"/> Passenger Air Bag Switch (if equipped) |
| <input type="checkbox"/> Trunk/Tailgate/Bed Lights (if equipped) | <input type="checkbox"/> Rollover Side Curtain Air Bag Switch (RSCA) |
| <input type="checkbox"/> Glove Box Light (if equipped) | <input type="checkbox"/> Horn |
| <input type="checkbox"/> ABS Light (if equipped) | <input type="checkbox"/> Seat Belt Warning Light
<i>If the warning lights remains on, it may indicate a system malfunction.</i> |
| <input type="checkbox"/> Rear Wiper/Washer (if equipped) | <input type="checkbox"/> Air Bag Warning Light
<i>If the warning lights remains on, it may indicate a system malfunction.</i> |
| <input type="checkbox"/> Clock (if equipped) | <input type="checkbox"/> Lamp Failure Sensor
<i>If the warning lights remains on, it may indicate a system malfunction.</i> |
| <input type="checkbox"/> Accessory Power Socket (if equipped) | <input type="checkbox"/> Track/Skid Control Light (if equipped)
<i>If the warning lights remains on, it may indicate a system malfunction.</i> |
| <input type="checkbox"/> Starter | <input type="checkbox"/> Tire Pressure Monitoring System (TPMS)
<i>Prior to TPMS activation and Pre-Delivery Service (PDS) of the vehicle the TPMS light will blink when IG is turned on. After TPMS activation and PDS of the vehicle the TPMS light will illuminate for a few seconds and go off when IG is turned on.</i> |
| <input type="checkbox"/> Audio/Video (if equipped) | |
| <input type="checkbox"/> Power Sliding Door (if equipped) | |
| <input type="checkbox"/> Convenience Memory Settings (if equipped) | |
| <input type="checkbox"/> Heated Seats (if equipped) | |