

ADVUV630

Owner's Manual

///ADVENT®



Introduction

Congratulations on your purchase of the ADVUV630 Mobile Multimedia Receiver. Please read the instruction manual for this product before using. The documentation provided will allow you to fully enjoy all the features this unit has to offer. Please save this manual for future reference.

iPhone®, iPod®, iPod classic, iPod nano, iPod shuffle, and iPod touch are trademarks of Apple Inc., registered in the U.S. and other countries.

“Made for iPod” and “Made for iPhone” mean that an electronic accessory has been designed to connect specifically to iPod or iPhone respectively, and has been certified by the developer to meet Apple performance standards. Apple is not responsible for the operation of this device or its compliance with safety and regulatory standards. Please note that the use of this accessory with iPod or iPhone may affect wireless performance.

Bluetooth® is a trade mark of Bluetooth Special Interest Group (SIG) Inc.

WARNING!

Never install this unit where operation and viewing could interfere with safe driving conditions.

WARNING!

To reduce the risk of a traffic accident (except when using for rear view video camera) never use the video display function while driving the vehicle. This is a violation of federal law.

WARNING!

To prevent injury from shock or fire, never expose this unit to moisture or water.

WARNING!

Never disassemble the unit.

WARNING!

Never use irregular discs.

WARNING!

To prevent damage to the mechanism inside this unit, avoid impact to the unit's monitor.

WARNING!

Using an improper fuse may cause damage to the unit and result in a fire.

Controls and Indicators	4
Main Menu	6
Main Menu - Page 1	6
Main Menu - Page 2	7
Audio Control Menu	8
AM/FM Radio	9
Loading Media	11
Audio Disc	12
JPEG/MPEG	13
JPEG Image Mode	13
MPEG Video Mode	14
DVD	15
JPEG/MPEG	16
Bluetooth	17
Bluetooth Menu	17
Connecting to a Bluetooth device	18
Connecting to a Bluetooth device	19
Bluetooth Setup Menu	20
Disconnecting	21
Making Calls	22
Managing Incoming Calls	23
Rear Camera	24
Camera Function	24
Rear Display Function	25
iPod/iPhone (Front USB/Rear USB)	26
iPod/iPhone Music Menu	26
iPod/iPhone Video Menu	28
iPod/iPhone Photo Menu	28
AV IN1/AV IN2 Input	29
XM Satellite Radio (Optional)	30
SWC (Steering Wheel Control)	32
System Settings Menu	33
Wallpaper	36
Troubleshooting	37
Error Messages	39
Care and Maintenance	40
Specifications	41

NOTE: Refer to the separate NavMate 5 Navigation Instructions for operating instructions related to navigation.

Controls and Indicators

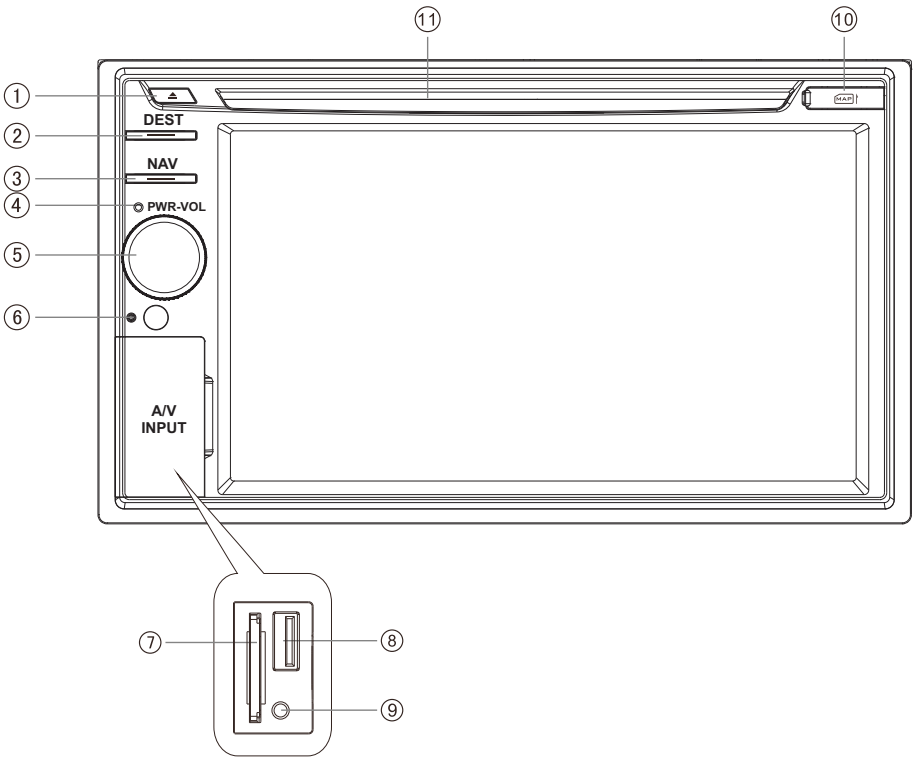

Getting Started

After pressing the **PWR-VOL** button to turn the unit on, the “Radio” screen appears.

To adjust equalizer settings, touch the **EQ** icon on the right side of the screen below the clock display (see “Audio Control Menu” on page 8).

To access the “Main Menu”, press the **MENU** button at the top left corner of the screen (see “Main Menu” on page 6). From the Main Menu, you can choose the source for the front and rear zone TFT screens, change the background wallpaper, or select the “Settings” menu to adjust a variety of system features.

1. **▲ Eject Button**

Press this button to eject a DVD/CD/MP3 disc. Disc play is stopped, the disc is ejected, and the unit will change to radio operation. If the disc is not removed from the unit and the button is pressed again, the disc will be re-loaded. If the disc is not removed from the disc slot within 10 seconds of being ejected, it will be automatically re-loaded to prevent accidental damage.

2. **DEST Button**

Press this button as a shortcut to access the Navigation mode and enter a desired destination.

3. **NAV Button**

Press this button to toggle between Navigation source and the current Audio source.

4. **Bluetooth Microphone**

The ADVUV630 has an internal microphone as well as an optional external microphone (Included). The internal Bluetooth microphone is located on the left side of the radio's faceplate. For best reception, speak loudly and clearly.

5. **PWR-VOL Controller (On/Off, Volume Control, Mute)**

Press to turn the unit on. *Press and hold* for 3 seconds to turn the unit off.

Increase the volume by rotating the knob clockwise. Decrease the volume by rotating the knob counter-clockwise. The unit's front panel screen will display the volume level for 3 seconds. The volume ranges from "0" to "50".

When on, press to mute the audio. Press again to restore the volume.

NOTE: The turn-on volume is preset to "16" to prevent the audio system from being too loud when powered on. If the volume is set lower than "16", this will be your turn-on volume. This setting is not adjustable.

6. **Reset**

Press to reset system to correct a system halt or other illegal operation, use the tip of a pen to press the reset button.

7. **SD/SDHC Card Slot**

Insert card for playback of audio/video files.

8. **USB Connector**

USB will charge with ≤ 1 Amp charging current while connected.

9. **A/V INPUT**

10. **Map Micro SD Card Slot**

11. **Disc Slot**

Accepts DVD/CD/MP3 discs.

Main Menu



Main Menu - Page 1

Disc:

Select CD/DVD mode, (CD/DVD must be inserted).

Radio:

Select AM/FM radio mode.

SD:

Access the contents of the SD Card (SD card must be inserted).

Front USB:

Access a device connected to the front (A/V Input) USB connector. When an iPod is connected, this icon is labeled "Front iPod" and shows an iPod image.

Bluetooth:

View the Bluetooth menu.

Camera:

Access a signal from an external camera (optional accessory).

Navigation:

Select navigation mode.

Rear USB:

Access a device connected to the rear USB connector. When an iPod is connected, this icon is labeled "Rear iPod" and shows an iPod image.

XM:

Select XM Radio mode.

AV IN1:

Access the AUX INPUT mode

Wallpaper:

Press to access the "Wallpaper" menu and choose from available wallpaper images. See "Wallpaper" on page 36.

Front/Rear TFT:

Independent sources can be played simultaneously on the ADVUV630. For example, a music source can be used on the main TFT screen while DVD video is available to rear passengers. Press **Rear TFT** on the bottom menu bar to switch between the front and rear zone source menus.

- Camera, NAV, XM, Radio and BT sources are only available on the front TFT.
- When the front TFT source is DISC, front USB, rear USB or SD source, and the rear TFT source is the same, the TFT output is the same on all screens.

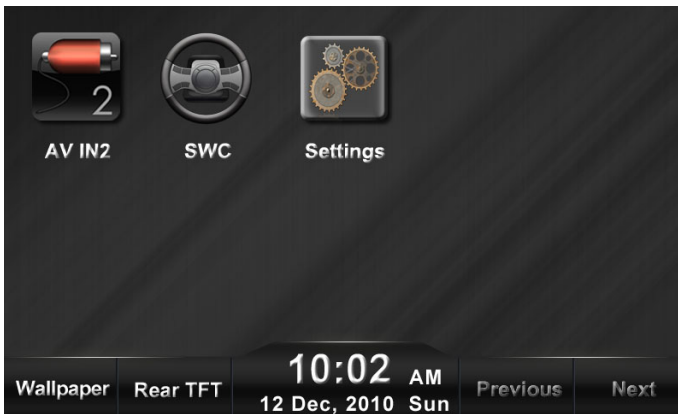

Main Menu - Page 2

- If the rear TFT source is AV IN1 or AV IN2, the front TFT source must be different since these AV IN sources cannot be shared between front and rear.

Next:

View a second page of menu choices.

AV IN2:

Access the audio/video input (AV2) mode.

SWC:

Access the Steering Wheel Control menu and assign functions.

Settings:

Access the unit's setup menu. The setup menu consists of a submenu which contains General, Video, Audio, and other unit settings.

Rear TFT:

Access the Rear TFT source menu options. Some sources (navigation, radio, camera, etc.) are not available for playback on rear TFT screens.

Previous:

Return to the first page of menu choices.

Rearrange Main Menu Icons:

Press and hold an icon, and then drag to relocate it to another position on the screen. The icon in the target destination will move to the vacant position.

Audio Control Menu



Audio Control Menu

The Audio Control feature allows you to easily adjust your audio system to meet the acoustical characteristics of your vehicle, which vary depending on the type of vehicle and its measurements. Proper setting of the Fader and Balance boosts the effects of the cabin equalizer.

Touch the  button on the screen to access the audio control menu. The "EQ" menu appears by default. Touch **FAD-BAL** to view the "Fader" menu and adjust Loudness, Subwoofer and Fader settings. To return to the "EQ" menu, touch **EQ**.

Use the touch screen to adjust the settings for an audio feature.

The Audio menu will automatically exit after a few seconds of inactivity. To exit quickly, touch the **BACK** button in the top left corner of the screen.

Audio Function	Adjustable Range
EQ (NOTE: The "User" setting is automatically selected when individual Bass, Mid and Treble settings are modified.)	Dance
	Hip Hop
	Rave
	User
	Acoustic
	Rock
	Latin
	Urban
Bass (85Hz)	-12 to +12
Mid-Range (1kHz)	-12 to +12
Treble (12.5Hz)	-12 to +12
Loudness	On/Off
Subwoofer	On/Off, 0 to +12
Fader	Front to Rear (Grid)
Balance	Left to right (Grid)



Radio Menu

Accessing Radio Mode:

To access Radio mode from the Main Menu, select the “Radio” icon.

MENU:

Press to access the “Main Menu” (see “Main Menu” on page 6). From the Main Menu, you can choose the source for the front and rear zone TFT screens, change the background wallpaper, or select the “Settings” menu to adjust a variety of system features.

Volume Level:

Displays the current volume level (VOL 0-50).

Band Indicator:

Indicates the frequency band that is currently playing (AM-1, AM-2, FM-1, FM-2, or FM3).

Clock Display:

Displays the time (12:19 AM) as entered by the user in the Settings Menu, clock function.

ST (Stereo):

This icon appears when the radio station frequency is broadcasted in stereo.

LOC (Local/Distance):

Touch to choose either Local or Distance radio reception. When the icon turns blue, only stations with sufficient signal strength will be detected.

EQ (Equalizer):

Touch to access the audio control menu to adjust audio settings (see “Audio Control Menu” on page 8).

◀◀:

Press to seek tune. *Press and hold* to tune the station down one step at a time.

▶▶:

Press to seek tune. *Press and hold* to tune the station up one step at a time.

P1 - P6:

Provides a display of the preset frequencies. Press to recall preset stations.

Mute:

This button is used to mute the volume from the radio. By pressing the button, a Mute indication will appear on the speaker icon and the volume will be muted.

Radio Menu

Band:

Press to select or change the radio band (AM-1, AM-2, FM-1, FM-2, or FM3). When the band is changed the presets associated with the band will also be displayed.

Scan:

Press to access the Auto-Store Tuning feature which will automatically scan and enter up to six strong stations into the six preset memory locations. If you have already set the preset memories to your favorite stations, activating the Auto-Store feature will erase those stations and enter the new strong stations. This feature is most useful when travelling in an area where you are not familiar with the local stations.

Direct Entry:

Press to access the direct tuning keyboard.



Enter the desired radio frequency using the keypad, and then press the check mark (✓) to tune to that frequency.

Mem:

Press to view the "Save" screen and store the current frequency to a preset memory position.



Touch one of the boxes labeled "P1"- "P6" to store the current frequency in that preset memory position. To cancel, press **BACK**.

PTY List:

The unit contains thirty two categories that can be searched. These categories consist of topics such as news, sports, types of music, etc.

Use the **Next/Previous** buttons to scroll through the list of available PTY categories.

While a category is highlighted (News, Sports, Talk etc.), press the **Enter** button to search for that topic.



Loading Media

Load Disc:

Playback begins automatically when a disc is inserted.

You can play video, audio or images stored on the following discs:

- DVD Video, DVD-R, DVD-RW
- VCD
- Audio CD, CD-R, CD-RW

Eject Disc:

Press the  button on the front panel to eject the disc. When the disc is ejected, the unit switches to the previous source.

Connect USB/iPod Device:

1. Open the AV/INPUT cover (or access the rear iPod connector).
2. Connect your USB/iPod cable to the front or rear USB input. Connect the other end of the cable to your USB/iPod device. When an iPod is attached, the corresponding source menu icon will display an iPod icon. For viewing iPod video, connect your jLinkUSB cable (optional) to the USB and 3.5mm connectors on the front or rear of the radio.

NOTE: The rear 3.5mm female connector bundled with the USB connector is for iPod video only. This is not an audio input and only works when an iPod is connected for video playback.

Remove the USB/iPod Device:

1. Select another source from the main menu.
2. Remove the USB/iPod device.

Insert SD Card:

1. Open the AV/INPUT cover.
2. Insert the SD Card into the SD card slot. Play starts automatically. SD card slot supports MP3, WMA, MPEG 1/2 and XviD formats.

Remove the SD Card:

1. Select another source on the main menu.
2. Press the card in to release.
3. Remove the SD card.

Audio Menu (iPod, USB, Disc, SD)

MENU:

Press to access the “Main Menu” (see “Main Menu” on page 6). From the Main Menu, you can choose the source for the front and rear zone TFT screens, change the background wallpaper, or select the “Settings” menu to adjust a variety of system features.

Clock Display:

Displays the time (12:19 AM) as entered by the user in the Settings Menu, clock function.

Random:

Press to access the random play function. This function will play the songs on the CD in a random, shuffled order.

In random play mode, pressing **Next** or **Previous** will also select tracks in a random order instead of the normal progression. Additional presses will select tracks in random order. Press the random play () icon to cancel the random play mode.

Repeat:

Press during disc playback to repeat playback of the current song. The  icon will appear. Press the icon a second time to repeat all tracks in the current folder. Press again to turn the repeat function off.

(Equalizer):

Touch to access the audio control menu to adjust audio settings (see “Audio Control Menu” on page 8).

Mute:

Press to mute the volume. A mute indication will appear on the speaker icon and the volume will be muted.

Previous:

Press to play the previous track on the disc. *Press and hold* to fast reverse.

Next:

Press to play the next track on the disc. *Press and hold* to fast forward.

Direct Entry:

Press to access the direct access song selection keyboard. Enter the desired track number and press the check mark () to play the selected track.

Play/Pause:

Press to begin playback. Press again to pause playback.

List:

Press once to view a list of the tracks contained on the disc. Press the **Up/Down** buttons to navigate the list of tracks or touch the track title. Once highlighted, touch the track title again to play.

Press the **List** space twice (**List** and then **Return**) to view a list of folders on the disc. Press the **Page Up/Page Down** buttons to navigate the list of folders or touch the folder name. Once highlighted, touch the folder name again to view the track titles in the selected folder. Repeat above process to select a track.



JPEG Image Mode

Navigating Files:

When a disc containing JPEG files is loaded in the unit, the Root Menu appears automatically. The Root Menu will display the contents of the disc.

Touch the  image on the left side of the screen (under the music note and film strip) to view a display of the images or image folders contained on the disc or card/device. JPEG images can be stored on the disc/card device as individual images or in folders.

When the file/folder list is displayed, press to select a folder or image name. Press again to display an image file or show contents of the folder. Repeat until the desired image is shown.

NOTE: Touch the top of the screen to view file information, including file type and number of files.

NOTE: On-screen controls do not work with iPod/iPhone images. You must use the iPod controls when displaying images stored on an iPod.

JPEG Menu Screen:

- **1/2**: Show 2nd page of controls.
- **◀◀**: View previous photo.
- **||**: Pause slideshow.
- **▶▶**: View next photo.
- **■**: Stop and return to previous screen.
- **Rotate**: Rotate image clockwise.
- **⌘**: Press to display the direct access keyboard. Enter a file number, then press the check mark (✓) to display.
- **2/2**: Show 1st page of controls.
- **🏠**: Shift image view upward.
- **◀**: Shift image view left.
- **▶**: Shift image view right.
- **⬇**: Shift image view downward.
- **Zoom**: Increase image size.
- **📄**: Display image file information at the top of the screen.

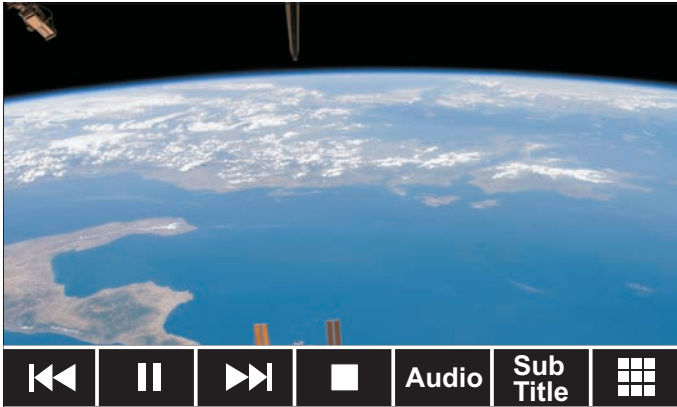

MPEG Video Mode

Navigating Files:

When loading a disc or device containing multiple MPEG, or a combination of media files, the Root Menu appears automatically. The Root Menu will display the contents of the disc, card or device. If only one MPEG file exists, playback will begin automatically.

Touch the film strip image on the left side of the screen (under the music note) to view a display of the MPEG files or folders contained on the disc or card/device. MPEG files can be stored as individual files or in folders.

When the file/folder list is displayed, press to select a folder or file name. Press again to play a file or show contents of the folder. Repeat until the desired file is played.

MPEG Menu Screen:

- : View previous file.
- / : Pause playback. Press again to play.
- : View next file.
- : Stop and return to previous screen.
- **Audio**: Direct audio to left, right or stereo output.
- **SubTitle**: Display subtitles, when available.
- : Press to display the direct access keyboard. Enter a file number, then press the check mark () to play.

NOTE: Touch the top of the screen to view file information including file type, elapsed and remaining playing time, and number of files.

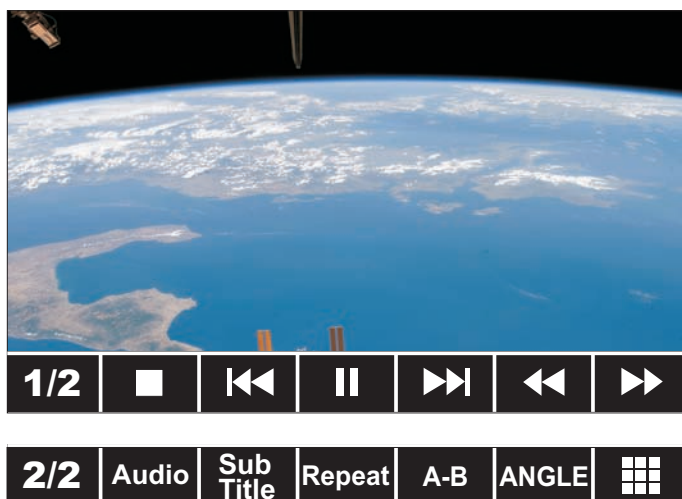

DVD Mode

Accessing DVD Mode:

When a DVD disc is loaded in the unit, playback begins automatically. To access DVD mode from the Main Menu, select the “Disc” icon.

DVD Touchscreen Areas:

Touch the areas indicated below to access on-screen options:

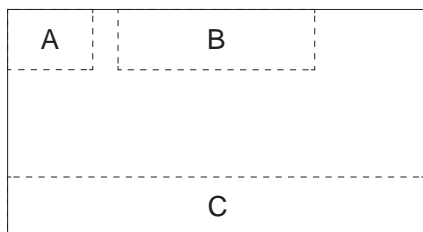

- Touch **A** to access the main menu.
- Touch **B** to view disc information, including file type, elapsed and remaining playing time, title and chapter number. Press twice consecutively to view audio, subtitle, angle and bitrate information.
- Touch **C** to view on-screen controls.



DVD On-Screen Controls:

- **1/2**: Show 2nd page of controls.
- **■**: Stop disc playback. Press again to resume playback.
- **◀◀**: Select previous chapter.
- **|| / ▶**: Pause playback. Press again to play.
- **▶▶**: Advance to next chapter.
- **◀◀**: Fast reverse at 2x, 4x, 8x and 20x. Press again to resume normal playback speed.
- **▶▶**: Fast forward at 2x, 4x, 8x and 20x. Press again to resume normal playback speed.
- **2/2**: Show 1st page of controls.
- **Audio**: Select the audio language. Each time the icon is pressed a different audio language is selected.
- **SubTitle**: Select the subtitle language (if the disc is recorded in multiple languages). Each time the icon is pressed a different subtitle language is selected. This function can also be turned on or off.

DVD Mode

- **Repeat:** Repeat the current chapter. Press the icon a second time to repeat the current title. Press the icon a third time to turn the repeat function off.
- **A-B:** Repeat a specific portion from point A to point B of the disc. During playback press **A-B** to set the starting point A. Press **A-B** a second time to set the ending point B. The player will repeatedly play the part between Point A and Point B. Press **A-B** a third time to cancel A-B repeat and resume playback.
- **ANGLE:** Some DVDs contain scenes that have been shot simultaneously from different angles. For a DVD disc recorded with multiple angles, press the ANGLE button to toggle the available angles of the on-screen image.
-  Display the direct access keyboard.



Press the  button to choose Chapter or Title entry. Next, enter a chapter or title number, and then press the check mark () to play.

You can also choose **Menu** to access the DVD root menu or **Title** to access the DVD title menu.

Press **Clear** to clear your entry and start over.

Press **Goto** to view the DVD search screen.

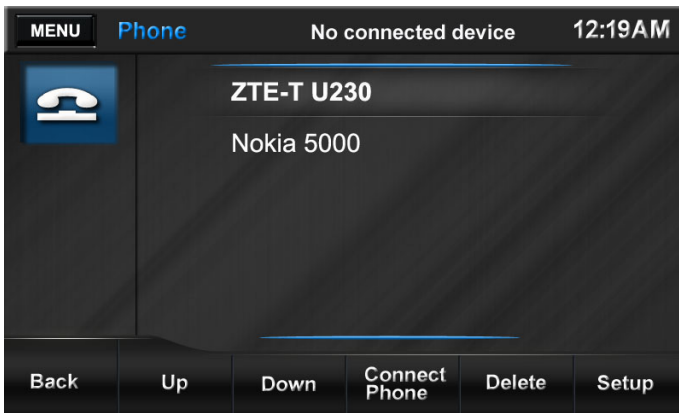

Bluetooth Menu

Entering Bluetooth Mode:

To enable Bluetooth mode, press the unit's front panel **MENU** button. Next, press the Settings icon on page 2 of the Setup menu. Select the Bluetooth submenu and set the "Bluetooth" option to "On".

Select the Bluetooth icon from the main menu to access the Bluetooth screen. Previously paired phones (if applicable) are listed in the center of the screen. Use the up/down buttons to navigate the list.

Initial Bluetooth Menu:

- **MENU:** Press to access the "Main Menu" (see "Main Menu" on page 6). From the Main Menu, you can choose the source for the front and rear zone TFT screens, change the background wallpaper, or select the "Settings" menu to adjust a variety of system features.
- Device Status (no device connected)
- **Clock Display:** Displays the time (12:19 AM) as entered by the user in the Settings Menu, clock function.
- **Back:** Return to previous screen.
- **Up:** Move up the menu list.
- **Down:** Move down the menu list.
- **Connect Phone:** Initiate pairing or reconnect highlighted phone.
- **Delete:** Remove highlighted phone from list.
- **Setup:** Open pop-up menu to view Bluetooth setup options.

Connecting to a Bluetooth device

Bluetooth® technology has the capability to wirelessly synchronize and transfer data among devices. The Bluetooth audio capabilities can be used for wireless phones hands-free applications. Bluetooth has many profiles and the unit is compatible with most Bluetooth enabled wireless phones. Before attempting to use the Bluetooth functions on the unit, please make sure your wireless phone supports Bluetooth functions.

NOTE: The line-of-sight distance between this unit and your cellular phone must be 30 feet (10 meters) or less for sending and receiving voice and data via Bluetooth wireless technology.

Before using Bluetooth functions, you must pair your wireless phone and the unit. Pairing is a special process used when two devices connect for the first time. The pairing process is used to generate a link key that is used for authentication purposes for future Bluetooth connections between devices. Refer to the procedures for “Pairing Your Wireless Phone” and “Pairing a Wireless Phone and the Unit.”

Pairing Your Wireless Phone:

Your wireless phone can be paired with the unit in two manners. The unit can initiate the search for compatible devices and pair to the wireless phone or the wireless phone can initiate the search and pair to the unit. The following paragraphs describe both methods.

NOTE: The following procedures are generic. Procedures for pairing wireless phones may vary slightly from phone manufacturer to phone manufacturer. Compatibility with all Bluetooth devices is not guaranteed.

Pairing a Wireless Phone and the Unit:

1. Select the Bluetooth setup option on the wireless phone to be paired (please refer to the wireless phone’s instruction manual to enter Bluetooth setup, turn Bluetooth on/off, and perform pairing). Access the wireless phone Bluetooth function and set the Bluetooth function to ON.
2. Set your wireless phone Bluetooth discover mode to ON.
NOTE: Some discover modes have a time limit, usually a minute, before they are automatically turned off.
3. Use the wireless phone’s add a new device feature. A device or devices will appear on your wireless phone display.
NOTE: Some phones require a “pass key” or pairing code to connect. If your phone requires a pass key or pairing code, you will need to enter this number in the Pairing Code field under the Bluetooth SETUP menu. The default pairing code for many wireless phones is “1234”. The default code for the unit is “0000”.
4. A prompt to pair or bond should appear on your wireless phone. Accept the request and initiate the process.
5. A prompt to enter a PIN number or passkey for the unit should appear. The default pass key for the unit is “0000”.
6. At this point a prompt stating pairing successful should appear. Another prompt should appear

Connecting to a Bluetooth device

asking connect to the unit, “Yes” or “No”. Press Yes. The wireless phone and the unit should pair and the wireless device name will appear at the top of the screen.



Once the Bluetooth main menu appears on the unit's front panel the wireless phone and the unit have paired.

Pairing the Unit and a Wireless Phone:

1. Press the front panel MENU button and then press the “Bluetooth” icon to access the Bluetooth main menu.



2. Select the Bluetooth setup option on the wireless phone to be paired (please refer to the wireless phone's instruction manual to enter Bluetooth setup, turn Bluetooth on/off, and perform pairing). Access the wireless phone Bluetooth function and set the Bluetooth function to ON.
3. Set your wireless phone Bluetooth

discover mode to ON.

NOTE: Some discover modes have a time limit, usually a minute, before they are automatically turned off.

4. On the Bluetooth main menu press the **Connect Phone** button.
5. Follow the prompts on your wireless phone to initiate pairing. At this point the wireless phone will ask the user to respond to a prompt similar to “Pairing request from ADVUV630 Accept? Yes or No “. The user should answer Yes to the request. Another prompt will appear on the wireless phone to enter the PIN or pass key.
6. Enter the PIN or pass key for the unit (0000). Acknowledge the unit's PIN or pass key on the wireless phone by pressing (ENTER, OK etc.). The following screen should appear.



Once the Bluetooth main menu appears on the unit's front panel, the wireless phone and the unit have paired.

NOTE: Any obstacle between this unit and a Bluetooth device can reduce the operational range.

NOTE: Keep this unit away from any other electronic devices that may cause interference.

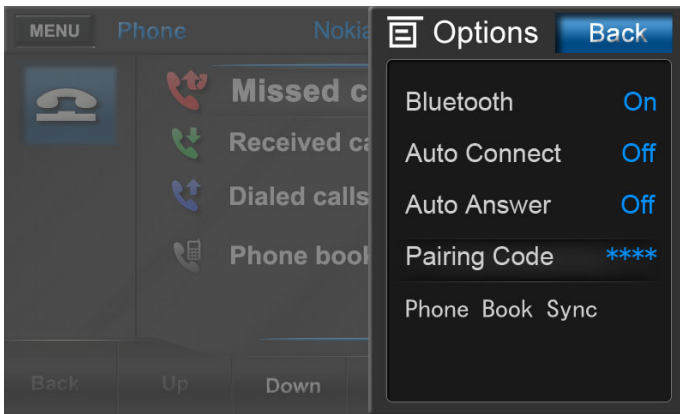

Bluetooth Setup Menu

To access the Bluetooth “Options” menu, press the **Setup** button.

Bluetooth:

Choose to turn the Bluetooth feature “On” or “Off.”

Auto Connect:

The “Auto Connect” option will allow the unit to automatically connect to a previously paired Bluetooth device when it is in range. When the Auto Connect option is set to “Off”, you must initiate the pairing process with your wireless phone. To enable the Auto Connect option, set this feature to “On.”

Auto Answer:

When this feature is set to “On,” the unit will automatically answer calls coming into the paired device.

Pairing Code:

Choose the “Pairing Code” option to access a keyboard allowing you to enter a new pairing code to be used when pairing this unit to your bluetooth devices (the default code is “0000”). Enter a new 4-digit pairing code and then press the check mark (✓).

To correct errors made while typing, you can press the **C** button to clear the entire entry or the back arrow (←) to delete the last digit entered.

Press the **Back** button to return to the main Bluetooth menu without changing the code.

Phone Book Sync:

Before you can use Phone Book list, you must first initiate the Phone Book Sync feature. This will also update your list of Missed Calls, Received Calls, and Dialed Calls.

After choosing “Phone Book Sync” from the menu, the unit will display the message “Sync Current Device’s Phonebook?” Press the check mark (✓) to begin syncing or click the X to cancel and return to the main Bluetooth menu.

Back:

Press the **Back** button at any time to return to the main Bluetooth menu without making changes to the above options.

NOTE: Not all wireless phones allow access to missed, received or dialed calls or address book support.



Disconnecting

Deleting a paired wireless device:

1. Press the front panel **MENU** button and then press the Bluetooth icon to access the Bluetooth main menu.
2. Touch to select the phone model number you want to delete and then press the **Delete** button.

Disconnect a Bluetooth device:

To disconnect a device, press the **Disconnect Phone** button.

The device will also be disconnected when the device is moved beyond the operational range (approximately 30 feet). When the "Auto Connect" feature is set to "On," you can reconnect the device to the unit by placing it within the operational range.

If you do not want to reconnect the device to the unit automatically, set Auto Connect" feature to "Off."

Making Calls

Make a call (keypad direct entry):

1. Press the front panel **MENU** button and then press the Bluetooth icon to access the Bluetooth main menu.
2. Pair the phone with the unit.
3. Press the **Direct Entry** button to view the keypad.



4. Enter a phone number and then press the  button.

Make a call (using lists):

1. Press the front panel **MENU** button and then press the Bluetooth icon to access the Bluetooth main menu.
2. Pair the phone with the unit.
3. Touch to view one of the following phone lists: Missed Calls, Received Calls, Dialed Calls or Phone Book. If you did not yet sync your phonebook, see "Bluetooth Setup Menu" on page 20 for syncing instructions.
4. Use the Up/Down buttons to navigate the list.
5. Touch to select a number.
6. Touch the number again to dial.



Cancel call in progress:

To cancel a call in progress, touch the **Hangup** button at the bottom of the screen.

Transfer call in progress:

To transfer a call in progress from the radio back to the mobile device, press the **Transfer** button at the bottom of the screen.

Mute call:

To mute the phone call audio from the unit when a call is received, press the **Mute** button. Press the **Mute** button again and the phone call will be restored to the unit.

External Microphone:

When a call is received, you can communicate with the caller using the unit's internal microphone or an optional external microphone. An external microphone (included with the ADVUV630) will, in some instances, improve the sound quality during communication.

The default setting for the unit is the internal microphone. Pressing the **External Mic** button will enable audio output to the optional external microphone (if connected).

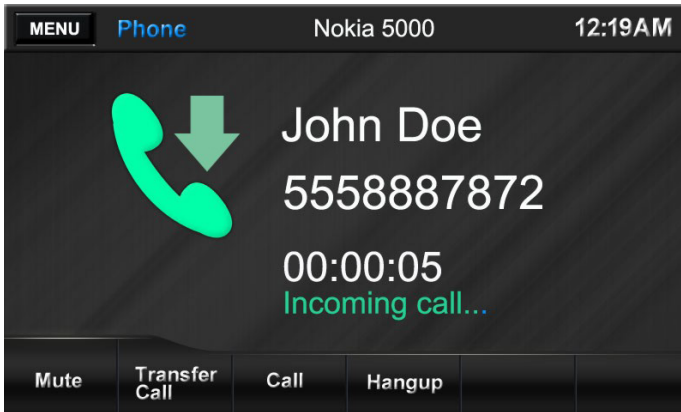

Managing Incoming Calls

Managing Incoming Calls:

When connected to a Bluetooth phone, the unit will mute audio output, pause disc play, and change to the Bluetooth screen when a call is received.

The incoming phone number and assigned name for that number will appear in the middle of the screen. An audible tone will sound from the unit and a graphic display will appear on the front panel. If the incoming call has no caller ID, the unit will display "Private Caller".

Answering an Incoming Call:

To answer the call, press the **Call** button. For best reception, speak loudly and clearly toward the external microphone. To end the conversation, press the **Hangup** button.

Rejecting an Incoming Call:

Press the **Hangup** button to reject an incoming call. The call will revert to your wireless phone and be left for voice mail.

Volume Control:

To increase or decrease the volume level, turn the **PWR-VOL** knob on the front panel.

Audio Mute:

To mute the phone call audio from the unit when a call is received, press the **Mute** button. Press the **Mute** button again and the phone call will be restored to the unit.

Camera Function

Rear Camera Function:

The unit is “camera ready.” Before accessing any camera features, you must install a rear video camera. When the camera is not installed and the function is accessed by the gear selector being placed in reverse or the unit’s menu, touching the **Camera** icon produces no response. When the camera is installed, the rear view image of what is behind the vehicle will appear when the vehicle’s gear selector lever is placed in reverse. When the lever is removed from the reverse position, the unit will return to the previous screen.

The rear camera image can be adjusted from the “Setup” menu under the “Video” submenu. The image can be changed from normal to mirror image.

Rear Display Function

The unit allows two sources to be played simultaneously. For example, the unit's screen can be set to the radio function while the rear passengers can watch a DVD video using an optional rear monitor.

The unit provides for connection of up to two additional monitors (sold separately) for rear passengers.

Perform the following to access the Rear TFT function:

1. Turn on the rear monitor. Refer to the monitor's owner's manual for instructions.
2. Insert the media (DVD, CD etc.) to be viewed into the unit.
3. Press the unit's touch screen **MENU** button and select the **Rear TFT** icon on the second page of menu options. The Rear TFT menu options appear on the screen.
4. Use the **MENU** icons (Disc, SD, Front USB, Rear USB, AV IN1, AV IN2, Rear Off and Front TFT) to select the playback source for the Rear TFT.
5. Control the rear zone function
6. Use the **Front/Rear TFT** button at the bottom of the screen to switch between front and rear MENU options.

NOTE: You cannot change or control the front zone source from the rear zone video screen.

iPod/iPhone (Front USB/Rear USB)

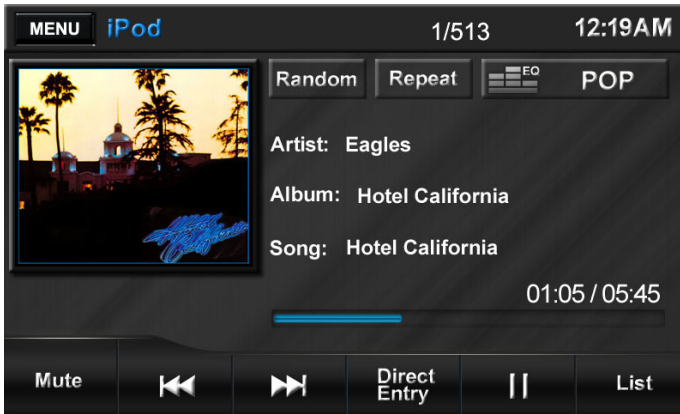

iPod/iPhone Music Menu

Accessing iPod Mode:



Press to access the “Main Menu” (see “Main Menu” on page 6). Connect a supported iPod or iPhone to the Front or rear USB connector. The iPod icon appears instead of the USB icon whenever an iPod or iPhone is attached to the Front or Rear USB connector. Press the **Front iPod** or **Rear iPod** icon to access iPod mode.

Music playback begins automatically.

Clock Display:

Displays the time (12:19 AM) as entered by the user in the Settings Menu, clock function.

Random:

This function will randomly reorganize all files on the iPod for playing in the new random order. You can view the random song order by pressing the **List** button. Press once to play all songs in random order. The  icon appears. Press twice to play the current album in random order. Press the random play () icon a third time to cancel random play mode.

In random play mode, pressing **Next** or **Previous** will select songs in the random order (as indicated on the List screen) instead of the normal progression.

Repeat:

Press during disc playback to repeat playback of the current file. The  icon will appear. Press the icon a second time to repeat all music files on the iPod. Press a third time to turn the repeat function off.

(Equalizer):

Touch to access the audio control menu to adjust audio settings (see “Audio Control Menu” on page 8).

Mute:

Press to mute the volume. A mute indication will appear on the speaker icon and the volume will be muted.

Press to play the previous file. *Press and hold* to fast reverse.

Press to play the next file. *Press and hold* to fast forward.

iPod/iPhone Music Menu

Direct Entry:

Press to access the direct access song selection keyboard. Enter the desired track number and press the check mark (✓) to play the selected track.



Press to begin playback. Press again to pause playback.

List:

Press once to view a list of the files contained on the iPod. Press the on-screen arrows to navigate the list of files or touch to select. Once highlighted, touch the file name again to play.



Press the **Page Up/Page Down** buttons to navigate screen lists. Once highlighted, touch to view options inside a folder. Repeat above process to select a file.

Press the **List** space twice (**List** and then **Return**) to view the iPod music menu.



- **Playlists:** Provides a list of all the Playlists that are stored in the iPod. Pressing the Playlist name will provide the song associated with Playlist. Pressing the title name will begin playback of the song.
- **Artists:** Provides a list of the performers that are stored in the iPod. Pressing the performers name will provide the title associated with the performers. Pressing the title name will begin playback of the item.
- **Albums:** Provides a list of the albums that are stored in the iPod. Pressing the albums provides the title name. Pressing the title name will begin playback of the item.
- **Songs:** Provides a list of the songs and audio items that are stored in the iPod. Pressing the title name will begin playback of the item.
- **Genres:** Provides a list of the categories that are contained in the iPod. Pressing the Genres icon will result in the artist names comprising the genre to be displayed. Pressing the artist's name will display the title name. Pressing the title name will begin playback of the item.
- **Composers:** Provides a list of composers of that are stored in the iPod. Pressing the composer's name will display the song's title. Pressing the title name will begin playback of the item.
- **Podcasts:** Provides a list of podcasts that are stored in the iPod. The podcasts usually consist of a series of digital audio files. Pressing the title name will begin playback of the podcast.

iPod/iPhone Video Menu

Press the film strip icon on the left side of the screen (under the music note) to view the iPod movie menu.

NOTE: You must use the optional jLink USB cable to view iPod video on this unit.

- **MOVIE:** Provides a list of all the movies that are stored in the iPod. Pressing the movie's name will begin playback of the movie.
- **RENTAL:** Provides a list of rental videos that are stored in the iPod. Pressing the title name will begin playback of the rental video.
- **TV SHOWS:** Provides a list of the TV shows that are stored in the iPod. Pressing the title name will begin playback of the item.
- **MUSIC VIDEOS:** Provides a list of the music videos that are stored in the iPod. Pressing the music video name will begin playback of the music video.
- **VIDEO PLAYLISTS:** Provides a list of all the Video Playlists that are stored in the iPod. Pressing the title name will begin playback of the video.
- **VIDEO PODCASTS:** Provides a list of podcasts that are stored in the iPod. The podcasts usually consist of a series of digital video files. Pressing the title name will begin playback of the podcast.

iPod/iPhone Photo Menu

Touch the  image on the left side of the screen (under the music note and film strip) to switch to iPod control and display iPod images on the unit's TFT screen.

You cannot directly control iPod image playback using the on-screen controls. You must use the iPod menu to control the images displayed after selecting iPod photo mode.



Auxiliary Audio/Video Input

AV IN1 Auxiliary Audio/Video Input:

The unit contains an auxiliary audio/video input which can accept signals from various audio/video devices. The A/V INPUT on the front panel (reference Item 9, Controls and Indicators) accepts a 3.5mm connector which has three female color coded RCA connectors on the opposite end. The yellow is used for video, the red accepts the right channel audio and the white accepts the left channel audio.

Perform the following steps to access audio/video using the unit's A/V INPUT:

1. Turn on the video /audio source component. Refer to the owner's manual for instructions.
2. Connect the device's output signal to the unit using the three RCA inputs (Yellow= Video, Red=Right Audio, White=Left Audio).
3. Press the unit's on-screen **MENU** button and select **AV IN1**.
4. Use the controls located on the device to begin playback and other control functions.

AV IN2 Auxiliary Audio/Video Input:

The unit contains a rear auxiliary audio/video inputs (AUX IN R, AUX IN L, AUX IN VIDEO) which can accept signals from various audio/video devices. The yellow is used for video, the red accepts the right channel audio and the white accepts the left channel audio.

Perform the following steps to access audio/video inputs using the unit's REAR AUX IN:

1. Turn on the video /audio source component. Refer to the owner's manual for instructions.
2. Connect the device's output signal to the unit using the three RCA inputs (Yellow= Video, Red=Right Audio, White=Left Audio).
3. Press the unit's on-screen **MENU** button and select **AV IN2**.
4. Use the controls located on the device to begin playback and other control functions.

XM Satellite Radio (Optional)



XM Radio Menu

Listeners can subscribe to XM® Radio on the Web by visiting www.xmradio.com, or by calling (800) 967-2346. Customers should have their Radio ID ready (see “Displaying the Identification (ID) Code”). Customers can receive a limited number of free-to-air channels without activation.

Accessing XM Radio Mode:

To access Radio mode from the Main Menu, select the “XM” icon.

Viewing the Identification (ID) Code:

Before you listen to satellite radio, you must subscribe to the service using your radio’s identification number. To display the radio ID, use the **Channel** **▶▶** / **◀◀** buttons to tune to channel “000”. The screen displays the radio ID where the channel name is usually displayed.

MENU:

Press to access the “Main Menu” (see “Main Menu” on page 6). From the Main Menu, you can choose the source for the front and rear zone TFT screens, change the background wallpaper, or select the “Settings” menu to adjust a variety of system features.

Band Indicator:

Indicates the frequency band currently playing (BAND 1, BAND 2 or BAND 3).

Signal Strength Indicator:

As the strength of the satellite radio signal increases, the number of illuminated segments will increase.

Clock Display:

Displays the time (12:19 AM) as entered by the user in the Settings Menu, clock function.

(Equalizer):

Touch to access the audio control menu to adjust audio settings (see “Audio Control Menu” on page 8).

Channel:

Use the next arrow (**▶▶**) or previous arrow (**◀◀**) to tune to available XM channels.

Category:

Use the next arrow (**▶▶**) or previous arrow (**◀◀**) to view the available XM categories. Categories group music by type such as jazz, rock, classical etc.

P1 - P6:

Provides a display of the preset

XM Radio Menu

frequencies. Press to recall preset stations.

Mute:

This button is used to mute the volume from the radio. By pressing the button, a Mute indication will appear on the speaker icon and the volume will be muted.

Band:

Press to select or change the radio band (Band 1, Band 2 or Band 3). When the band is changed the presets associated with the band will also be displayed.

Scan:

Press to access the Auto-Store Tuning feature which will automatically scan and enter up to six strong stations into the six preset memory locations. If you have already set the preset memories to your favorite stations, activating the Auto-Store feature will erase those stations and enter the new strong stations. This feature is most useful when travelling in an area where you are not familiar with the local stations.

Direct Entry:

Press to access the direct tuning keyboard.



Enter the number corresponding to a desired XM channel using the keypad, and then press the check mark (✓) to tune to that frequency.

Mem:

Press to view the "Save" screen and store the current frequency to a preset memory position.



Touch one of the boxes labeled "P1"- "P6" to store the current frequency in that preset memory position. To cancel, press **BACK**. The channel can now be recalled at any time by pressing that preset.

Channel Guide:

When pressed, a channel list is displayed with the current channel in play highlighted. Use the up/down arrows and scroll bar on the right to view the available XM radio channels.

SWC (Steering Wheel Control)

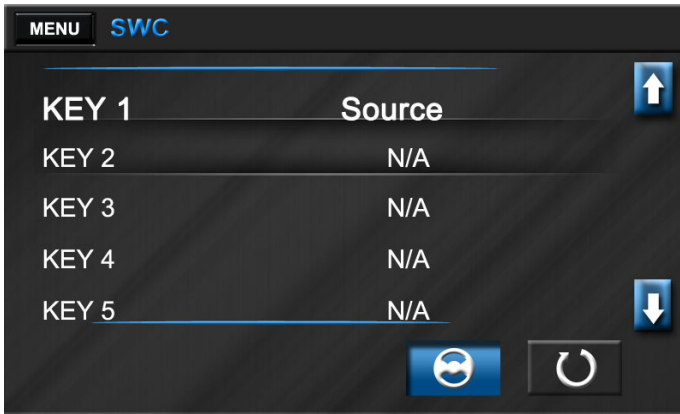



SWC Menu



The ADVUV630 is compatible with the PAC (Pacific Accessory Corporation) steering wheel control adapter SWI-PS. A 3.5mm female connector (labeled "SWC") on the back of the head unit allows connectivity to the PAC adapter. Please refer to the instructions included with the PAC adapter for detailed installation information. The steering wheel control option allows you to program your existing steering wheel controls to work with the ADVUV630.

Accessing the "SWC" Menu:

To access SWC mode, select the "SWC" icon on page 2 of the Main Menu.

NOTE: Before you begin, you MUST press the  button to clear any prior programming options. If a mistake is made during the programming sequence, press the  button to clear all settings and start over. Otherwise, the steering wheel control function may not function properly.

Programming Keys 1-7:

1. Press the  button to clear any existing program settings.
2. Touch the option (N/A) next to each Key number to open a window with possible programming options (use the up/down arrow buttons on the right side of the screen to view additional Key choices).
3. Use the up/down arrows to navigate the list. Touch to select the desired function for the selected Key number.
4. Continue with Key 1 - Key 7 (Keys +1 through +7 are reserved for future use).
5. After selecting a desired function for each Key (1-7), press the  button to begin programming your choices to the buttons on your steering wheel control. Follow the on-screen commands to complete this process, pressing the left/right arrow buttons to move between Key selections.

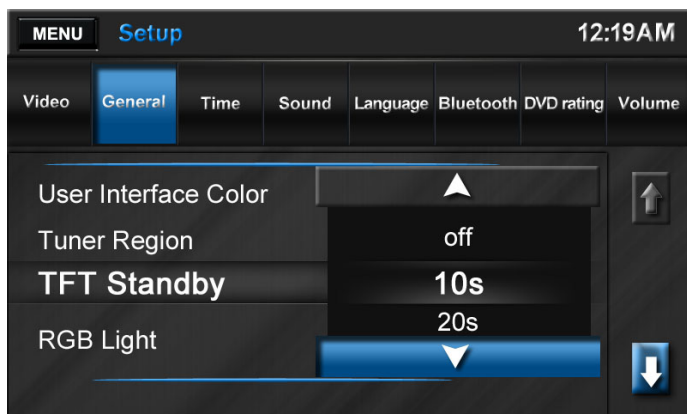

Settings Menu

Accessing the “Setup” Menu:

Press **MENU** to access the “Main Menu.” Press **Next** to view a second page of menu options and then select the **Settings** icon.

Accessing Menu Items:

Press the submenu feature you wish to adjust (Video, General, etc.). The submenu feature for adjustment will be highlighted. Pressing the feature will display the adjustable parameters. Available menu options are as follows:

Video Menu Options:

- **Aspect Ratio:** Choose Full
- **Rear Camera:** The Rear Camera input can be displayed on the unit’s front panel in “Normal View” or a “Mirrored View”. In the “Mirror View” the camera image is reversed as if looking through a rear-view mirror.

General Menu Options:

- **User Interface Color:** Choose White, Red, Blue, Amber or Green to determine the accent color for buttons and specific text for on-screen menus.
- **Tuner Region:** Choose the region

that corresponds with your location (USA or Europe).

- **TFT Standby:** Select the length of time to pass before the TFT standby feature activates (10 seconds or 20 seconds).
- **RGB Light:** The RGB light illuminates the front panel buttons (eject, PWR-VOL, etc.) There are 8 preset colors and 3 custom color options. Choose the “Scan Color” option to preview the 8 preset color options. Press to select a color. The Edit Color menu allows you to design a custom color. To begin, touch the **Edit Color** option and then press to highlight Custom 1, 2 or 3. Touch Adjust to open the “Edit Color” window. To choose a custom color, drag across the color bar or input the RGB value using the +/- arrow buttons on the right side of the screen. Touch **Initialize** to load (factory installed) the original backlight color.
- **Beep:** An audible beep tone occurs when front panel or on-screen control buttons are pressed. The beep tone can be disabled by setting this

Settings Menu

- option to “Off.”
- **Wallpaper:** Choose a preferred wallpaper image (Black, Shore Waves, Lotus Flower, Smart Cars, Dense Flowers, User Defined) to be displayed behind the Main Menu options. Select the “User Defined” option to load up to 12 user-defined wallpaper images using the Micro-SD slot located at the top right corner of the front panel (labeled “MAP”).
- **Calibration:** This touch screen calibration adjustment is used to set the parameters of the touch screen to ensure that when the screen is pressed that it corresponds to the feature the user is selecting. To calibrate the screen, first select the Touch Screen Calibration. Press the Yes icon and it will be selected. Follow the instructions on the screen to press and briefly hold the stylus. The stylus will move to each corner of the screen and finally to the center. If the screen is pressed the new calibration parameters will be accepted. If the screen is not pressed within the thirty seconds, the new parameters will be disregarded.

Time Menu Options:

- **Date:** To adjust the date, press to select the “Date” option and then use the on-screen arrows to adjust the month, day and year fields.
- **Clock mode:** Press to choose the 12 hour or 24 hour clock format.
- **Time:** To adjust the time, press to select the “Time” option and then use the on-screen arrows to adjust the hour and minute fields.

Sound Menu Options:

- **Subwoofer filter:** This option allows the Sub Filter Frequency to be set to the following frequencies to optimize the audio output for your vehicle: 80Hz, 120Hz or 160Hz.
- **DRC:** Set the Dynamic Range Control to “On” for better playback at low volumes.

Language Menu Options:

DVD subtitle and Menu options are dependent on individual DVD discs. To choose a default language, touch to select the option and then use the on-screen arrows to choose from languages available on the current disc. Note that the selected default language may not be available on all discs.

- **OSD:** Select the on-screen language display.
- **DVD Audio:** Select the DVD audio language.
- **DVD Subtitle:** Select the DVD subtitle language.
- **Disc Menu:** Select the DVD menu language.

Bluetooth Menu Options:

- **Bluetooth:** Turn the Bluetooth function on/off.
- **Auto Connect:** When set to “On”, if a previously paired device is within range, the unit reconnects to the device automatically. When set to “Off” the user must manually connect to paired devices.
- **Auto Answer:** Set to “On” to answer incoming calls to a paired device automatically. Choose “Off” to manually answer incoming calls.
- **Microphone:** Choose to use the built-in internal microphone or the external (optional and included) microphone.
- **Pairing Code:** Set the password

Settings Menu

for pairing the unit with Bluetooth devices.

DVD Rating Menu Options:

- **Set Password:** Set the password to restrict playback of disc content determined by the “Rating Level” option. The default code is “4321.”
- **Rating Level:** Choose an appropriate rating level to be playing without the use of a password.

Kid safe	Acceptable for children.
G	Acceptable for general viewers.
PG	Parental guidance recommended.
PG-13	Unsuitable for children under the age of 13.
PG-R	Recommended that parents restrict viewing by children under 17.
R	Parental approval recommended for children under the age of 17.
NC-17	Unsuitable for children under the age of 17.
Adult	Acceptable for adults only.

- **Factory Default:** Restore factory default rating settings.

Volume Menu Options:

The Volume option allows you to adjust the volume for a source automatically when switching to that mode. To automatically increase volume for a source, touch to select that source and then use the on-screen arrow buttons to choose an adjustment level from 1-12.

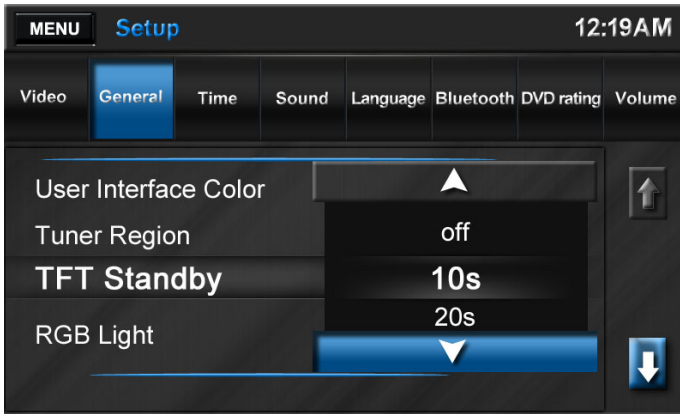

User-Defined Wallpaper

Accessing the “Wallpaper” Screen:

Press **MENU** to access the “Main Menu.” Press **Wallpaper** to access the “Wallpaper” screen.

You can also access the “Wallpaper” screen from the “Setup” menu by choosing the **Settings** button. Choose “Wallpaper” from the “General” menu and select the “User Defined” option.

You can store up to 12 JPEG or Bitmap images in flash memory for use as wallpaper.

Adding User-Defined Images:

1. Temporarily remove the Map data card from the Micro SD slot labeled “MAP” located at the top right corner of the unit.
2. Load a micro SD card with preferred wallpaper images (low resolution offers better performance) into the Micro SD card. Wait a few seconds for the images to load.
NOTE: DO NOT load or delete any data from the MAP SD card.
3. Select the **SD card** button on the “Wallpaper” screen to view the directories and the files on the card. Select a directory and then press

the **Enter** button to view the directory contents. Press the **Enter** button to the right side of the directory name to go up a level.

4. Select a JPEG or Bitmap image and then press the **Enter** button to load it into flash memory and apply as wallpaper.
5. Remove the Micro SD card containing the wallpaper images and replace the map data card.

Reviewing and Selecting Stored Images:

Press the **Back** button to view images stored in flash memory. Use the up/down arrows on the right to navigate the list. Select an image to see a preview. Press the **Enter** button to use it as wallpaper.

Deleting Stored Images:

To delete stored images, select the image and press the **Delete** button.

Problem	Cause	Corrective Action
GENERAL		
Unit will not power on	Radio fuse blown	Install new fuse with correct rating
	Car battery fuse blown	Install new fuse with correct rating
	Illegal operation	Press the RESET button located in the bottom left corner of the front panel
No/low audio output	Improper audio output connection	Check wiring and correct
	Volume set too low	Increase volume level
	Improper "MUTE" connection	Review wiring diagram and check "MUTE" connection
	Speakers damaged	Replace speakers
	Heavily biased volume balance	Adjust the channel balance to the center position
	Speaker wiring is in contact with metal part of car	Insulate all speaker wiring connections
Poor sound quality or distortion	Pirated disc is in use	Use original copy
	Speaker power rating not compatible with unit	Connect proper speakers
	Speaker is shorted	Check speaker contact
Unit resets itself when engine is off	Incorrect connection between ACC and positive battery wire	Check wiring and correct
TFT MONITOR		
No image	Incorrect connection to parking brake wire	Check wiring and correct
	Parking brake is not engaged	Stop vehicle in safe place and apply parking brake
Flashing image or interference appears on screen	DVD is not compatible with current TV system settings	Change setup to accommodate disc
	Improper video signal connections	Check wiring and correct
Prolonged image or improper height/width ratio display	Improper aspect ratio setup	Use correct aspect ratio setting

Troubleshooting

Problem	Cause	Corrective Action
TUNER		
Weak station searching	Vehicle antenna is not fully extended	Connect the vehicle antenna control cable properly
	Vehicle antenna not properly connected	Connect the vehicle antenna control cable properly
	LOCAL function is activated	Use LO/DX button to turn LOCAL function off
Cannot insert disc	Disc already inside unit	Eject current disc and insert new one
Image blurred, distorted, or dark	Disc is illegally copied	Use original disc
Disc does not play back	Disc is warped or scratched	Use disc in good condition
	Disc is dirty or wet	Clean disc with soft cloth
	Laser pickup is dirty	Clean laser pickup with cleaning disc
	Incompatible disc is used	Use compatible disc
	Disc rating exceeds Parental Lock rating limit	Change Parental Lock settings to lower restriction
	Disc region code is not compatible with unit	Use disc with proper region code
	Disc is inserted upside down	Insert disc with label side up
PBC cannot be used during VCD playback	PBC is not available on the disc	
No repeat or searching while playing VCD	PBC is on	Turn PBC off
MP3		
Interruption occurred during playback	Disc is dirty or scratched	Clean disc or replace
	File is damaged/bad recording	Recreate disc with good files

Error Messages

Message Displayed	Cause	Corrective Action
Loading	Disc is being read	
No Disc	Disc is dirty	Clean disc with soft cloth
	Disc is upside down	Insert disc with label side up
	Disc not present in loading compartment	Insert disc
Bad Disc	Disc is dirty	Clean disc with soft cloth
	Disc is upside down	Insert disc with label side up
Unknown disc	Disc format is not compatible with this unit	
Region Error	DVD is not compatible with region code of unit	
Error	Illegal mechanism operation	Press the EJECT key for 5 seconds to reset the loading mechanism

Care and Maintenance

1. Use only a clean silicone cloth and neutral detergent to clean the front panel or monitor. A rough cloth and non-neutral detergent (such as alcohol) may result in scratching or discoloration.
2. Do not get water or cleaning fluids on the unit.
3. If the temperature inside the player gets too hot, a protective circuit automatically stops play of the disc. If this occurs, allow the unit to cool before operating the player again.
4. Never insert anything other than a 5" (12 cm) compact disc into the player as the mechanism can be damaged by foreign objects.
5. Do not attempt to use a 3" (8 cm) CD-Single disc in this unit, either with or without an adaptor, as damage to the player and/or disc may occur. Such damage is not covered by the Warranty on this product.
6. The CD player may not operate properly in extreme hot or cold. If such conditions occur, allow the interior of the vehicle to reach a normal temperature before using player.
7. When the vehicle warms up during cold weather or under damp conditions, condensation may appear on the LCD panel. Should this occur, the screen will not operate properly until the moisture has evaporated.
8. We suggest you use a cleaning disc in this unit more frequently than in the unit in your home due to the environmental conditions of the vehicle.

DVD/CD Player

Compatible Disc Media: DVD + R / RW (Single and Dual Layer) and CD-R / RW
Compatible Media Formats: CD-DA, MP3, WMA, VCD, SVCD, Xvid, AVI, MPEG1 / 2
Signal to Noise Ratio: > 95dBA
Dynamic Range: > 95dB
Frequency Response: 20Hz to 20 kHz, -3dB
Channel Separation: > 60dB @ 1 kHz
D/A Converter: High performance 24-bit / 192 kHz sample rate, Multi-Bit Sigma-Delta Modulator

Video

Format: NTSC, PAL (auto-detection)
Output: 1Vp-p (75-ohm)
Input: 1Vp-p (75-ohm)

FM Tuner

Tuning Range: 87.5MHz - 107.9MHz
Mono Sensitivity (-30dB): 9dBf
Quieting Sensitivity (-50dB): 15dBf
Alternate Channel Selectivity: 70dB
Signal to Noise Ratio @ 1 kHz: 58dB
Image Rejection: 80dB
Stereo Separation @ 1 kHz: > 30dB
Frequency Response: 30Hz - 15 kHz, -3d

AM Tuner

Tuning Range: 530 kHz - 1720 kHz
Sensitivity (-20dB): 15uV
Signal to Noise Ratio @ 1 kHz: 50dB
Image Rejection: 60dB
Frequency Response: 50Hz - 2 kHz, -3dB

Monitor

Screen Size: 6.2" (Measured diagonally), 16:9 Widescreen
Screen Type: High Definition TFT Liquid Crystal Display (LCD)
Resolution: 1,152,000 sub pixels, 800x3 (W) X 480 (H)

General

Auxiliary Input impedance: 10k
Power Supply: 11 to 16VDC, negative ground
Power Antenna (Blue): 500mA max, current limited protection
Amplifier Remote (Blue/White): 500mA max, current limited protection
Operating Temperature: -20C ~ 65C
Fuse: 15-amp, mini ATM type
DIN chassis dimensions: 7" X 7" X 4" (178mm x 178mm x 50mm)



CEA Power Ratings

Power Output: 13 Watts RMS x 4 channels into 4-Ohms @ < 1% THD+N
Signal to Noise Ratio: 70dBA below reference (Reference: 1 Watt, 4-Ohms)
Frequency Response: 20 Hz - 20 kHz, -3dB. (Aux Input used as reference input)
Reference Supply Voltage: 14.4VDC

**Specifications subject to change without notice.*

///ADVENT®

Audiovox Electronics Corporation
Hauppauge, NY 11788
Technical Assistance: 1-800-323-4815
www.audiovox.com

© 2011 Audiovox
Ver. 011911
Printed in China