

CE 90

ALARM CLOCK RADIO

OPERATION INSTRUCTIONS

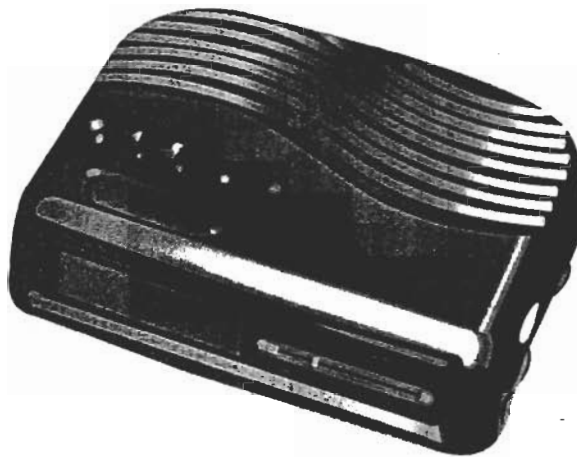

The lightning flash and arrowhead within the triangle is a warning sign alerting you of "dangerous voltage" inside the product.

WARNING

**RISK OF ELECTRIC SHOCK
DO NOT OPEN**

CAUTION: TO REDUCE THE RISK OF ELECTRIC SHOCK, DO NOT REMOVE COVER (OR BACK) NO USER-SERVICEABLE PARTS INSIDE. REFER SERVICING TO QUALIFIED SERVICE PERSONNEL.



The exclamation point within the triangle is a warning sign alerting you of important instructions accompanying the product.

WARNING: TO REDUCE THE RISK OF FIRE OR ELECTRIC SHOCK, DO NOT EXPOSE THIS APPLIANCE TO RAIN OR MOISTURE.

* SEE BOTTOM OF UNIT FOR GRAPHIC SYMBOLS *

* DO NOT CONNECT FM ANTENNA TO EXTERNAL ANTENNA *

WARNING

To prevent fire or shock hazard do not expose the unit to rain or moisture.

- To avoid electrical shock, do not open the cabinet. Refer servicing to qualified personnel only.

FEATURES

- Electronic digital alarm clock and sleep timer are combined.
- Two wake-up modes available: radio or buzzer alarm.
- Power back-up function to keep the clock operating during a power interruption, using an optional 6F22 battery.

PRECAUTIONS

- To disconnect the cord, pull it out by the plug, not by the cord.
- Avoid exposure to temperature extremes; direct sunlight, moisture, sand, dust or mechanical shock.
Allow adequate air circulation to prevent internal heat build-up. Do not place the unit on surfaces (rugs, blankets, etc.) or near materials (curtains, draperies) that may block the ventilation holes.
- Should any solid object or liquid fall into the unit, unplug the unit and have it checked by qualified personnel before operating it any further.
- When cleaning the casing, use a soft cloth dampened with a mild detergent solution. Never use abrasive cleansers or chemical solvents.

This device complies with Part 15 of FCC Rules. Operations is subject to the following two conditions: (1) this device may not cause harmful interference, and (2) this device must accept any interference received, including interference that may cause undesirable operation.

LOCATION OF CONTROLS

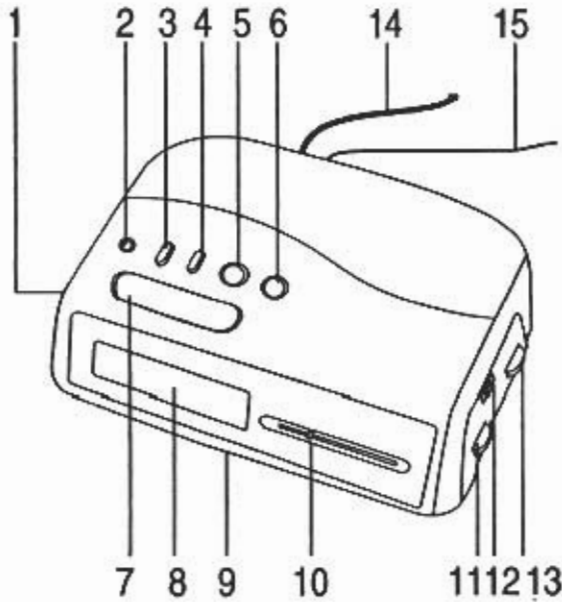

- 1. Function selector [ON/OFF/
RADIO BUZZER]
- 2. CLOCK set button
- 3. HOUR set button [HR]
- 4. MINUTE set button [MIN]
- 5. ALARM set button
- 6. SLEEP set button
- 7. SNOOZE/SLEEP OFF button
- 8. Time display
- 9. Power back-up battery
compartment [bottom]
- 10. Radio dial scale

- 11. TUNING control
- 12. BAND selector
- 13. VOLUME control
- 14. AC power cord
- 15. Antenna wire

TIME DISPLAY INDICATOR

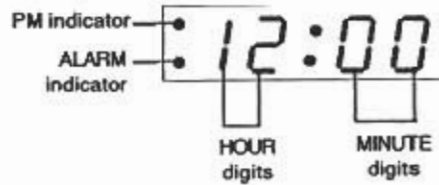

POWER SUPPLY

USING HOUSE CURRENT

Before use, check that the rated voltage of your unit matches your local voltage.

Caution: To prevent electrical shock, match wide blade of plug to wide slot, fully insert.

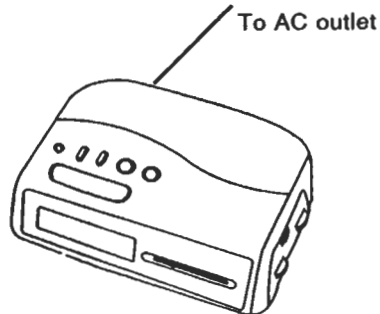

POWER BACK UP DURING POWER INTERRUPTION

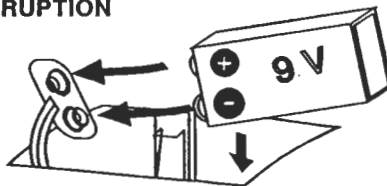

Insert one "6F22" battery

Be sure to install an optional 9V battery for the power back-up function. If the AC power supply is interrupted, the battery supplies power to keep the clock operating and holding the alarm time setting.

- During power interruption, the clock function is maintained although illumination of the indicator goes off, but the alarm sound does not come on.
- After a power interruption, the displayed time may not be always correct (it may gain or lose less than ten minutes per hour).

This battery is only for clock operation and alarm memory during power interruption. You cannot listen to the radio with the battery.

When to replace the battery

To check the battery condition, unplug the AC power cord from the wall outlet and plug it in again after a few minutes. If the displayed time is incorrect, replace the battery with a new one.

Caution

- Be sure to install the battery before disconnecting the AC power cord.
- When the unit is left unplugged for a long time, remove the battery to avoid undue battery discharge and unit damage from battery leakage.

HOW TO SET THE CLOCK

1. While pressing the CLOCK set button, press the HR button to the desired hour.



2. While pressing the CLOCK set button, press the MIN button to the desired minute.



• PM 12:00 = NOON time , and PM indicator will light up.

LISTENING TO THE RADIO

1. Set to ON.



2. Select a band



3. Tune in to a station

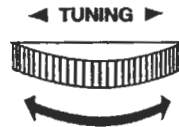

4. Adjust the volume.



5. After listening
Set to OFF.



To improve the radio reception
FM: Extend the external antenna wire

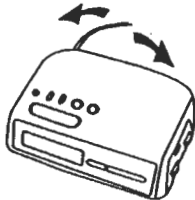

AM: Rotate the unit horizontally

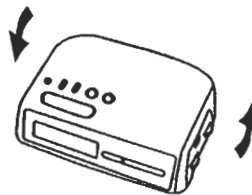

Int
sa
ng
int
lis
he

NOT

WAKE UP TO ALARM [RADIO OR BUZZER]

1. While pressing the ALARM button, press the HR button to the desired hour.

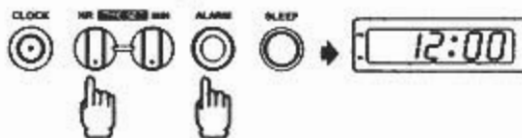

2. While pressing the ALARM button, press the MIN button to the desired minute.

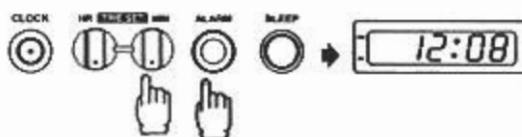

3. For radio alarm

First tune in the desired station and adjust the volume.
Set to RADIO



- For buzzer alarm

Set to BUZZER



4. The AL [Alarm] indicator will lights up

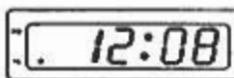

- Set to RADIO or BUZZER will come on at the preset time, and shut off automatically after 119 minutes.

HOW TO TURN OFF THE ALARM

1. If you want to snooze a few more minute.

Press the SNOOZE button will deactivate the sound for 9 minute. You can repeat this function as many times as you like within 119 minutes from the preset alarm time.

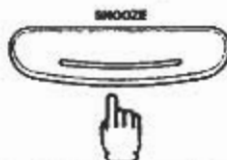

2. To complete cancel the alarm mode.

Press the ALARM button, and it will resume after 24 hours.

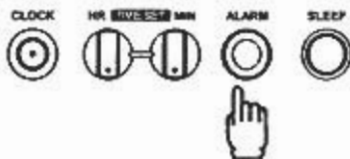

HOW TO SET THE SLEEP TIMER

- 1. While listening to the radio,**
Set to OFF.

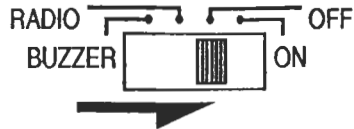

- 2. Press SLEEP.**

The radio turns on, and will turn off after 59 minutes.



OR

maximum to 119 minutes.
Press SLEEP and HOUR.



maximum to 119 minutes.
Press SLEEP and MINUTE button, will be counted down automatically.



- 3. Turn off the SLEEP before 59 minutes.**
Press the SNOOZE button.

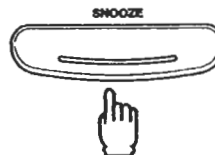

SPECIFICATION

Frequency range	FM: 88-108 MHz AM: 530-1700 kHz
Antennas	FM: 1 meter antenna wire AM: Built-in ferrite bar antenna
Speaker	8 Ohm
Power output	240mW [at 10% total harmonic distortion]
Power requirements	120V AC, 60 Hz For the power backup function: 9V DC, one 6F22 battery
Dimensions	Approx. 179x132.2x54.8mm [W/D/H]
Weight	Approx. 560g [not inculed battery]

Design and specifications subject to change without notice.

IMPORTANT SAFETY INSTRUCTIONS

1. **Read Instructions** - All the safety and operating instructions should be read before the appliance is operated.
2. **Retain Instructions** - The safety and operating instructions should be retained for future reference.
3. **Heed Warnings** - All warnings on the appliance and in the operating instructions should be adhered to.
4. **Follow Instructions** - All operating and use instructions should be followed.
5. **Water and Moisture** - The appliance should not be used near water - for example, near a bathtub, washbowl, kitchen sink, laundry tub, in a wet basement, or near a swimming pool, and the like.
6. **Carts and Stands** - The appliance should be used only with a cart or stand that is recommended by the manufacturer.
- 6A. An appliance and cart combination should be moved with care. Quick stops, excessive force, and uneven surfaces may cause the appliance and cart combination to overturn.
7. **Wall or Ceiling Mounting** - The appliance should be mounted to a wall or ceiling only as recommended by the manufacturer.
8. **Ventilation** - The appliance should be situated so that its location or position does not interfere with its proper ventilation. For example, the appliance should not be situated on a bed, sofa, rug, or similar surface that may block the ventilation openings; or, placed in a built-in installation, such as a book case or cabinet that may impede the flow of air through the ventilation openings.
9. **Heat** - The appliance should be situated away from heat sources such as radiators, heat registers, stoves, or other appliances (including amplifiers) that produce heat.
10. **Power Sources** - The appliance should be connected to a power supply only of the type described in the operating instructions or as marked on the appliance.
11. **Grounding or Polarization** - Precautions should be taken so that the grounding or polarization means of an appliance is not defeated.
12. **Power-Cord Protection** - Power-supply cords should be routed so that they are not likely to be walked on or pinched by items placed upon or against them, paying particular attention to cords at plugs, convenience receptacles, and the point where they exit from the appliance.
13. **Cleaning** - The appliance should be cleaned only as recommended by the manufacturer.
14. **Power Lines** - An outdoor antenna should be located away from power lines.



- 15. Outdoor Antenna Grounding** - If an outside antenna is connected to the receiver, be sure the antenna system is grounded so as to provide some protection against voltage surges and built up static charges. Section 810 of the National Electrical Code, ANSI/ NFPA No. 70, provides information with respect to proper grounding of the mast and supporting structure, grounding of the lead-in wire to an antenna discharge unit, size of grounding conductors, location of antenna-discharge unit, connection to grounding electrodes, and requirements for the grounding electrode. See Figure 1.

FIGURE 1
EXAMPLE OF ANTENNA GROUNDING
AS PER NATIONAL
ELECTRICAL CODE

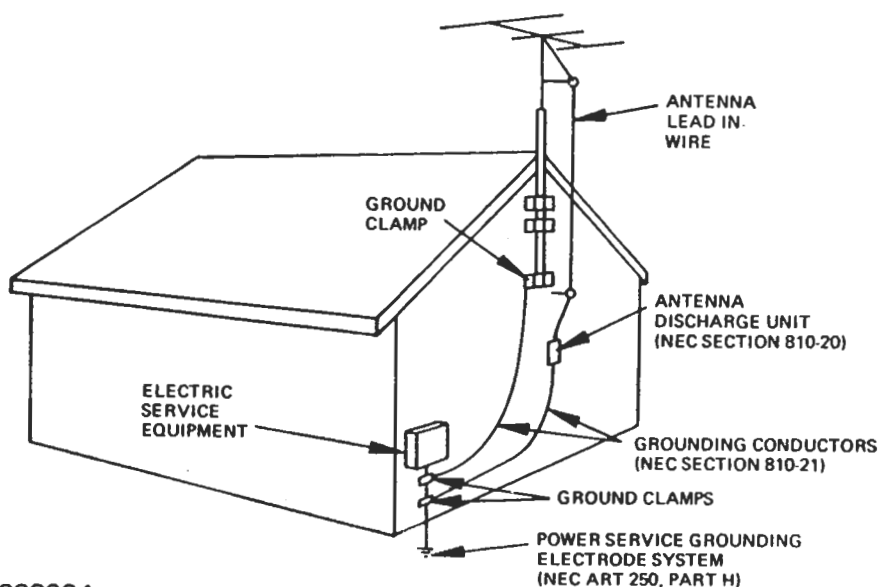

S2898A NEC - NATIONAL ELECTRICAL CODE

- 16. Nonuse Periods** - The power cord of the appliance should be unplugged from the outlet when left unused for a long period of time.
- 17. Object and Liquid Entry** - Care should be taken so that objects do not fall and liquids are not spilled into the enclosure through openings.
- 18. Damage Requiring Service** - The appliance should be serviced by qualified service personnel when:
- The power-supply cord or the plug has been damaged; or
 - Objects have fallen, or liquid has been spilled into the appliance; or
 - The appliance has been exposed to rain; or
 - The appliance does not appear to operate normally or exhibits a marked change in performance, or
 - The appliance has been dropped, or the enclosure damaged.
- 19. Servicing** - The user should not attempt to service the appliance beyond that described in the operating instructions. All other servicing should be referred to qualified service personnel.