



AUDIOVOX®
ELECTRONICS CORP.

LCD TV

FPE4707HR

Operating Manual



Before connecting, operating or adjusting this product, please read the manual completely.

Please keep this manual for future reference.

FOR ASSISTANCE CALL 1-800-619-3848 OR VISIT US AT WWW.AUDIOVOX.COM.

128-8036

Table of Contents

Important Information	1
Important Safety Precautions	2
Setup	5
Identification of Controls	8
Connections	12
Basic Operations	18
Memorizing the Channels	20
Channel Selection	22
Setting Picture	23
Setting Picture/Adjusting Image	24
Setting Sound	25
System Setup	27
Clock and Timer Setup	28
Viewing Closed Captions	29
Setting Parental Control	30
PIP/PBP/POP Operations	34
Electronic Program Guide	36
Image Adjust for PC/Component Mode	37
Image Adjust for HDMI Mode	38
Troubleshooting	39
Care and Maintenance	40
Specifications	41
Programming the Universal Remote Control	42

Important Information

WARNING: TO REDUCE THE RISK OF FIRE OR ELECTRIC SHOCK, DO NOT EXPOSE THIS APPARATUS TO RAIN OR MOISTURE.

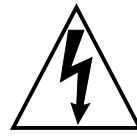
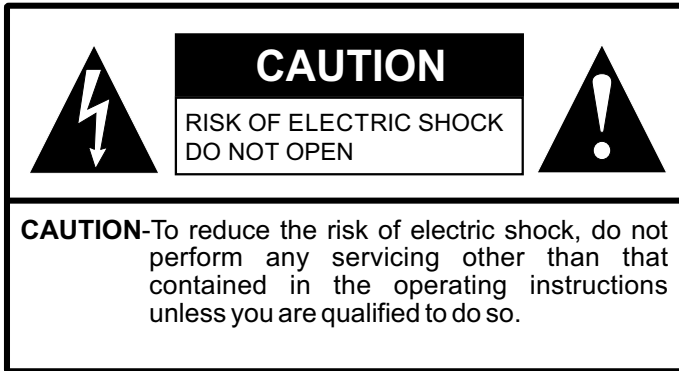

The lightning flash with arrowhead symbol, within an equilateral triangle is intended to alert the user to the presence of uninsulated dangerous voltage within the product's enclosure that may be of sufficient magnitude to constitute a risk of electric shock to persons.



The exclamation point within an equilateral triangle is intended to alert the user to the presence of important operating and maintenance (servicing) instructions in the literature accompanying the appliance.

This product utilizes tin-lead solder, and fluorescent lamp containing a small amount of mercury. Disposal of these materials may be regulated due to environmental considerations. For disposal or recycling information, please contact your local authorities or the Electronic Industries Alliance: www.eia.org

FCC STATEMENT

FCC Notice

LCD TV: A CLASS B digital device

This equipment has been tested and found to comply with the limits for a Class B digital device, pursuant to part 15 of the FCC Rules. These limits are designed to provide reasonable protection against harmful interference when the equipment is operated in a commercial environment.

This equipment generates, uses, and can radiate radio frequency energy and, if not installed and used in accordance with the instruction manual, may cause harmful interference to radio communications. Operation of this equipment in a residential area is likely to cause harmful interference in which case the user will be required to correct the interference at his own expense.

FCC CAUTION:

Pursuant to 47CFR, Part 15.21 of the FCC rules, any changes or modifications to this monitor not expressly approved by the manufacturer could cause harmful interference and would void the user's authority to operate this device.

WARNING: This is a CLASS B product. In a domestic environment this product may cause radio interference in which case the user may be required to take adequate measures to counter interference.

Important Safety Precautions

Electrical energy can perform many useful functions, but it can also cause personal injuries and property damage if improperly handled. This product has been engineered and manufactured with the highest priority on safety. But **IMPROPER USE CAN RESULT IN POTENTIAL ELECTRICAL SHOCK OR FIRE HAZARD**. In order to prevent potential danger, please observe the following instructions when installing, operating and cleaning the product. To ensure your safety and prolong the service life of your LCD TV product, please read the following precautions carefully before using the product.

- 1. Read these instructions**---All operating instructions must be read and understood before the product is operated.
- 2. Keep these instructions**---These safety and operating instructions must be kept in a safe place for future reference.
- 3. Heed all warnings**---All warnings on the product and in the instructions must be observed closely.
- 4. Follow all instructions**---All operating instructions must be followed.

5. Do not use this apparatus near water---for example, near a bathtub, washbowl, kitchen sink, or laundry tub, in a wet basement, or near a swimming pool, and the like. Do not use immediately after moving from a low temperature to high temperature environment, as this causes condensation, which may result in fire, electric shock, or other hazards.

Apparatus shall not be exposed to dripping or splashing and no objects filled with liquids, such as vases, shall be placed on the apparatus.

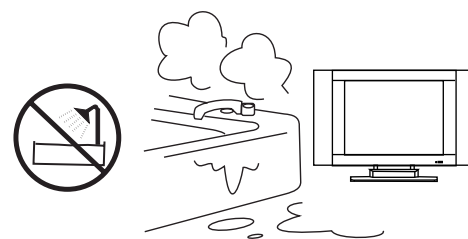

6. Clean only with dry cloth---Unplug this product from the wall outlet before cleaning. Do not use liquid cleaners or aerosol cleaners. Use a damp cloth for cleaning.

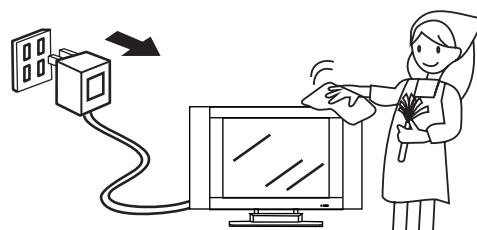

7. Ventilation---Do not block any ventilation openings. Install in accordance with the manufacturer instructions. The vents and other openings in the cabinet are designed for ventilation. Do not cover or block these vents and openings since insufficient ventilation can cause overheating and/or shorten the life of the product. Do not place the product on a bed, sofa, rug or other similar surface, since they can block ventilation openings. This product is not designed for built-in installation; do not place the product in an enclosed place such as a bookcase or rack, unless proper ventilation is provided or the manufacturer's instructions are followed.

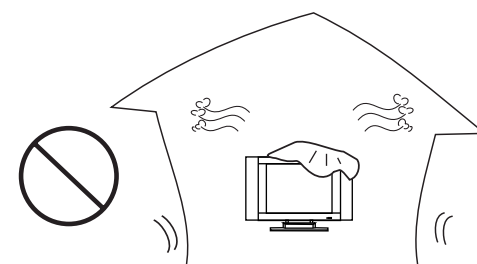

8. Heat sources---Do not install near any heat sources such as radiators, heat registers, stoves, or other apparatus (including amplifiers) that produce heat.

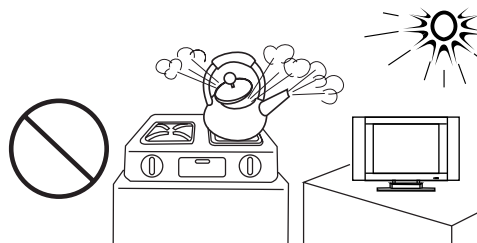

9. Grounding or Polarization---Do not defeat the safety purpose of the polarized or grounding-type plug. A polarized plug has two blades with one wider than the other. A grounding type plug has two blades and a third grounding prong. The wide blade or the third prong are provided for your safety. If the provided plug does not fit into your outlet, consult an electrician for replacement of the obsolete outlet.

10. Power cord protection---Protect the power cord from being walked on or pinched particularly at plugs, convenience receptacles, and the point where they exit from the apparatus.

NOTE: where the mains plug or an appliance coupler is used as the disconnect device, the disconnect device shall remain readily operable.

11. Attachments---Only use attachments/accessories specified by the manufacturer. Do not use attachments not recommended by the manufacturer. Use of improper attachments can result in accidents.

Important Safety Precautions (continued)

12. Stand---Use only with the cart, stand, tripod, bracket, or table specified by the manufacturer, or sold with the apparatus. Do not place the product on an unstable trolley, stand, tripod or table. Placing the product on an unstable base can cause the product to fall, resulting in serious personal injuries as well as damage to the product. When mounting the product on a wall, be sure to follow the manufacturer's instructions. Use only the mounting hardware recommended by the manufacturer.

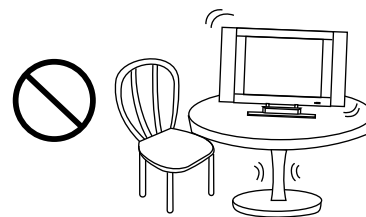

13. Move Carefully---When a cart is used, use caution when moving the cart/apparatus combination to avoid injury from tip-over. Sudden stops, excessive force and uneven floor surfaces can cause the product to fall from the trolley.

Never attempt to move the TV unless the AC power cord has been disconnected.



14. Lightning---Unplug this apparatus during lightning storms or when unused for long periods of time.

For added protection for this television equipment during a lightning storm, or when it is left unattended and unused for long periods of time, unplug it from the wall outlet and disconnect the antenna. This will prevent damage to the equipment due to lightning and power-line surges.

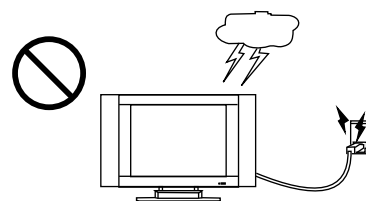

15. Servicing---Refer all servicing to qualified service personnel. Servicing is required when the apparatus has been damaged in any way, such as power-supply cord or plug is damaged, liquid has been spilled or objects have fallen into the apparatus, the apparatus has been exposed to rain or moisture, does not operate normally, or has been dropped.

16. Replacement parts---In case the product needs replacement parts, make sure that the service person uses replacement parts specified by the manufacturer, or those with the same characteristics and performance as the original parts. Use of unauthorized parts can result in fire, electric shock and/or other danger.

17. Overloading---Do not overload wall outlets, extension cords, or convenience receptacles on other equipment as this can result in a risk of fire or electric shock.

18. Entering of objects and liquids---Never insert an object into the product through vents or openings. High voltage flows in the product, and inserting an object can cause electric shock and/or short internal parts. For the same reason, do not spill water or liquid on the product.

19. Damage requiring service---If any of the following conditions occurs, unplug the power cord from the AC outlet, and request a qualified service person to perform repairs.

a. When the power cord or plug is damaged.

b. When a liquid is spilled on the product or when objects have fallen into the product.

c. When the product has been exposed to rain or water.

d. When the product does not operate properly as described in the operating instructions.

Do not touch the controls other than those described in the operating instructions. Improper adjustment of controls not described in the instructions can cause damage, which often requires extensive adjustment work by a qualified technician.

e. If the product has been dropped or the cabinet has been damaged in any way.

f. When the product displays an abnormal condition or exhibits a distinct change in performance. Any noticeable abnormality in the product indicates that the product needs servicing.

20. Safety checks---Upon completion of service or repair work, request the service technician to perform safety checks to ensure that the product is in proper operating condition.

21. Wall or ceiling mounting---When mounting the product on a wall or ceiling, be sure to install the product according to the method recommended by the manufacturer. This is a safety feature.

Important Safety Precautions (continued)

22. Power source---This product is intended to be supplied by a listed power supply indicated on the marking label. If you are not sure of the type of power supply to your home, consult your product dealer or local power company. For added protection for this product during a lightning storm, or when it is left unattended and unused for long periods of time, unplug it from the wall outlet and disconnect the cable system. This will prevent damage to the product due to lightning and power line surges. When the unit has to be used with another power supply voltage, the power cable must be changed. Consult your product dealer. The socket outlet should be installed near the equipment and easily accessible. Use only the power cord designated by our dealer to ensure safety and EMC. When connecting other products such as VCRs and personal computers, you should turn off the power of the unit for protection against electric shock.

23. Panel protection---The LCD panel used in this product is made of glass. Therefore, it can break when the product is dropped or impacted upon by other objects. Be careful not to be injured by broken glass pieces in case the LCD panel breaks.

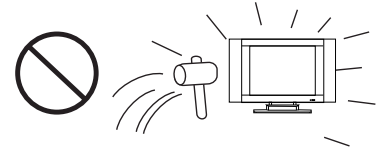

24. Pixel defect---The LCD panel is a very high technology product, giving you finely detailed pictures. Occasionally, a few non-active pixels may appear on the screen as a fixed point of blue, green or red. Please note that this does not affect the performance of your product.

WARNING: For continued safety, apparatus with class I construction shall be connected to a mains socket outlet with a protective earthing connection.

Setup

Using the Remote Control

- Use the remote control by pointing it towards the remote sensor window of the set. Objects between the remote control and sensor window may prevent proper operation.

Note: This illustration is for reference only. The remote sensor may be in different locations on different models.

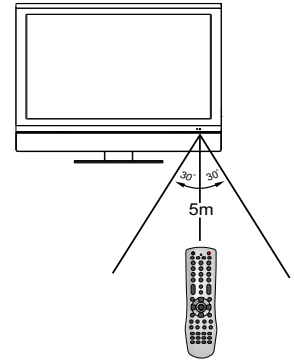

Cautions regarding use of remote control

- Do not expose the remote control to shock. In addition, do not expose the remote control to liquids, and do not place in an area with high humidity.
- Do not install or place the remote control under direct sunlight. The heat may cause deformation of the unit.
- The remote control may not work properly if the remote sensor window of the main unit is under direct sunlight or strong lighting. In such a case, change the angle of the lighting or TV set, or operate the remote control closer to the remote sensor window.

Batteries for the Remote Control

1 Open the battery cover.

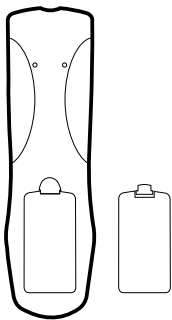

2 Insert two size-AA batteries.

- (Place the batteries with their terminals corresponding to the (+) and (-) indications in the battery compartment.)

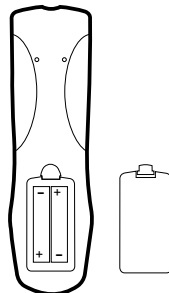

3 Replace the cover.

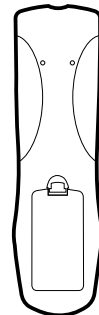

Precaution on battery use

Improper use of batteries can result in a leakage of chemicals and/or explosion. Be sure to follow the instructions below.

- Place batteries with their terminals corresponding to the (+) and (-) indications.
- Different types of batteries have different characteristics. Do not mix batteries of different types.
- Do not mix old and new batteries. Mixing old and new batteries can shorten the life of new batteries and/or cause old batteries to leak chemicals.
- Remove batteries as soon as they are non-operable. Chemicals that leak from batteries can cause a rash. If chemical leakage is found, wipe with a cloth.
- The batteries supplied with the product may have a shorter life expectancy due to storage conditions.
- If the remote control is not used for an extended period of time, remove the batteries from the remote control.

Setup

Power connection

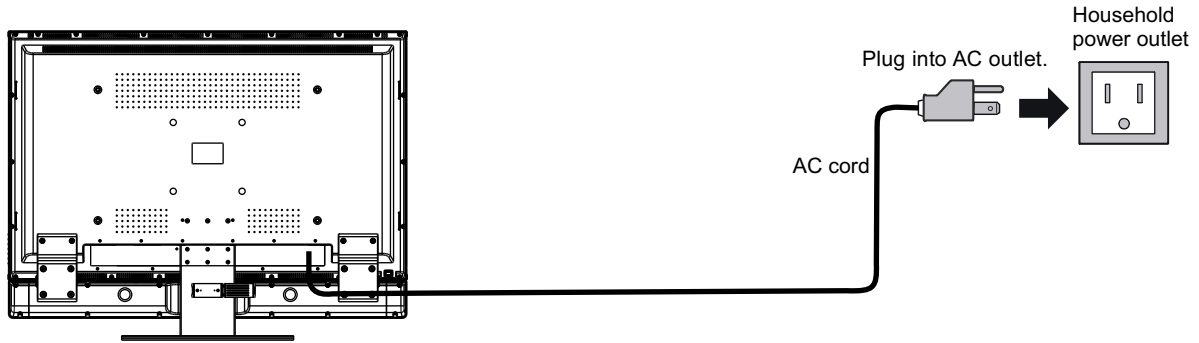

Connecting the AC plug to the wall outlet as illustrated.

Note:

- This product should be operated only from the type of power source indicated on the marking label.
- Always unplug the AC cord from power outlet when not using for a long period of time.

Speaker connection

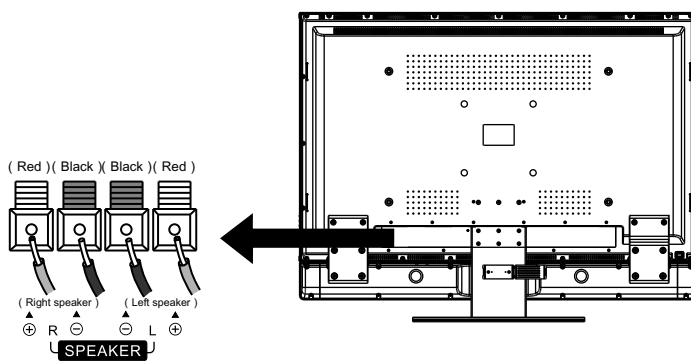

Connect the speaker audio cable to the external speaker output jack on the unit matching the "+" and "-" ends of the cable.

Note:

1. Unplug the TV set and all connected components before connecting the speakers.
2. The illustration may be different depending on model.

Setup

Antenna Connection

- For proper reception of VHF/UHF channels, an external antenna is required. For best reception, an outdoor antenna is recommended.
- When you enjoy the terrestrial TV programs, connect the antenna to the **AIR** input on the TV rear.
- When you enjoy the cable TV programs, connect the cable TV's cable to the **CABLE** input on the TV rear.
- Select the TV Source (**AIR** or **CABLE**) in the CHANNEL SETUP menu and then perform auto channel search.(See <Memorizing the Channels> section)

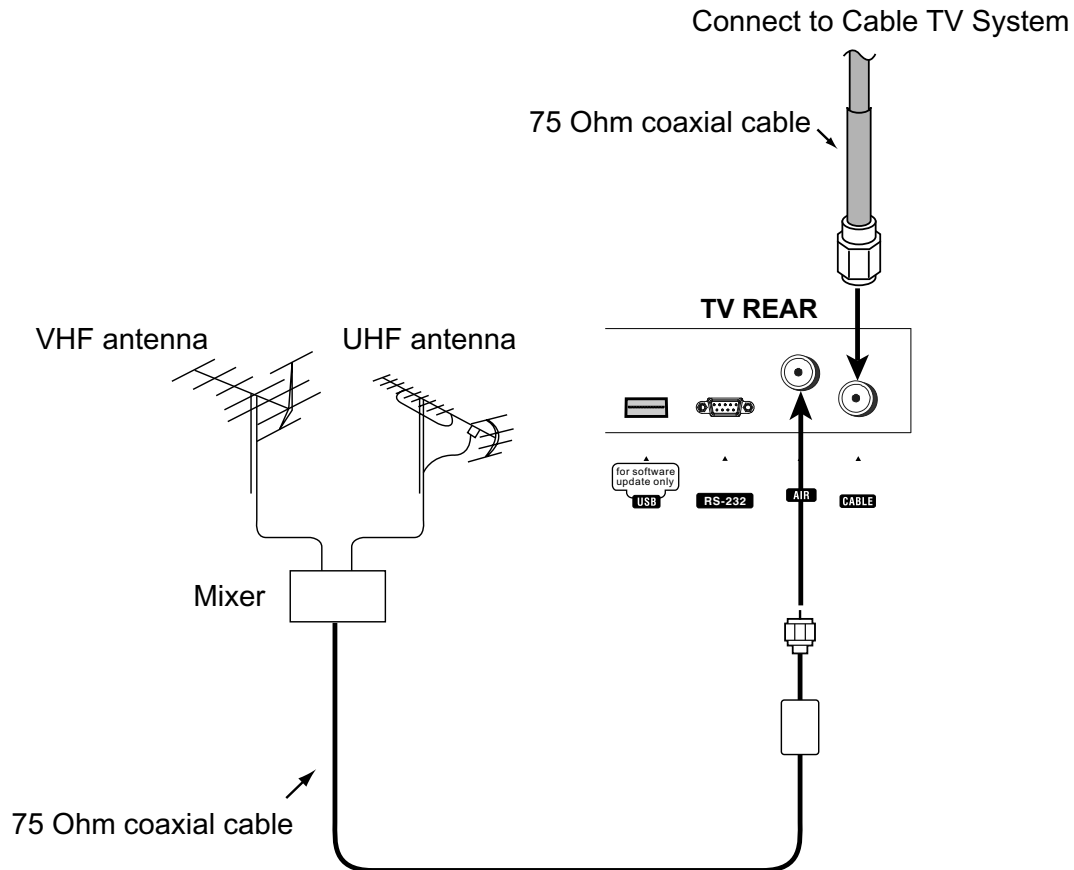

Notes:

- To obtain optimum quality picture and sound, an antenna, the correct cable (75 Ohm coaxial) and the correct terminating plug are required.
- If a communal antenna system is used, you may require the correct connection cable and plug between the wall antenna socket and your television receiver.
- Your local television service centre or dealer may be able to assist you in obtaining the correct antenna system for your particular area and the accessories required.
- Any matters regarding antenna installation, upgrading of existing systems or accessories required, and the costs incurred, are your responsibility.

Identification of Controls

Main unit (front view)

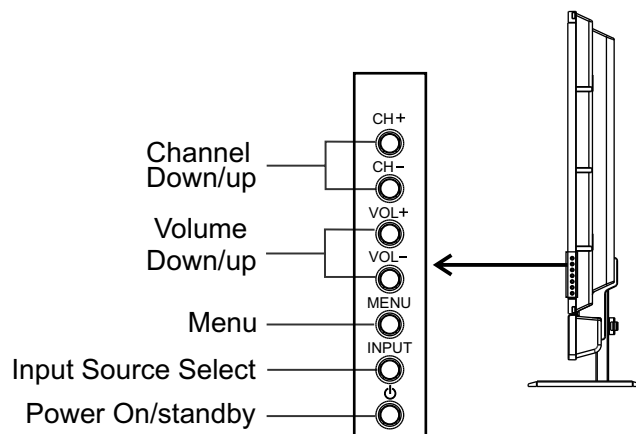
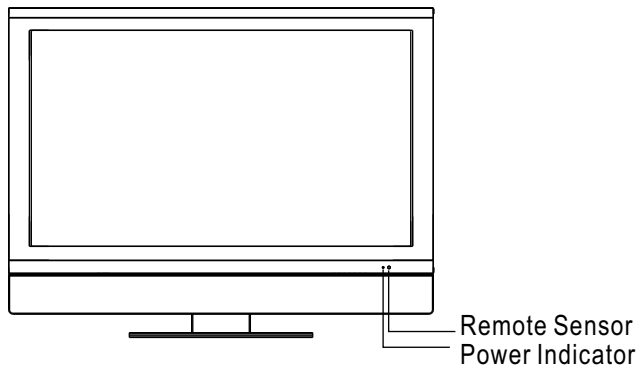

1. POWER ⏻

Press this button to turn the unit ON from STANDBY mode. Press it again to turn the set back to STANDBY.

2. INPUT

To select the input signal source

3. MENU

Press this button to access the MENU main page.

4. Volume up/down

Press the Volume up/down button to directly increase or decrease the sound volume level.
In OSD Menu, press these buttons to adjust the value or setting of each item

5. Channel up/down

Channel up or down.

In OSD Menu, press these buttons to choose the OSD items.

Note:

POWER ⏻, **VOL+/-**, **CH+/-**, **MENU** and **INPUT** on the main unit have the same functions as the corresponding buttons on the remote control.

This operation manual provides a description based on operating functions with the remote control.

Identification of Controls (continued)

Main unit (rear view)

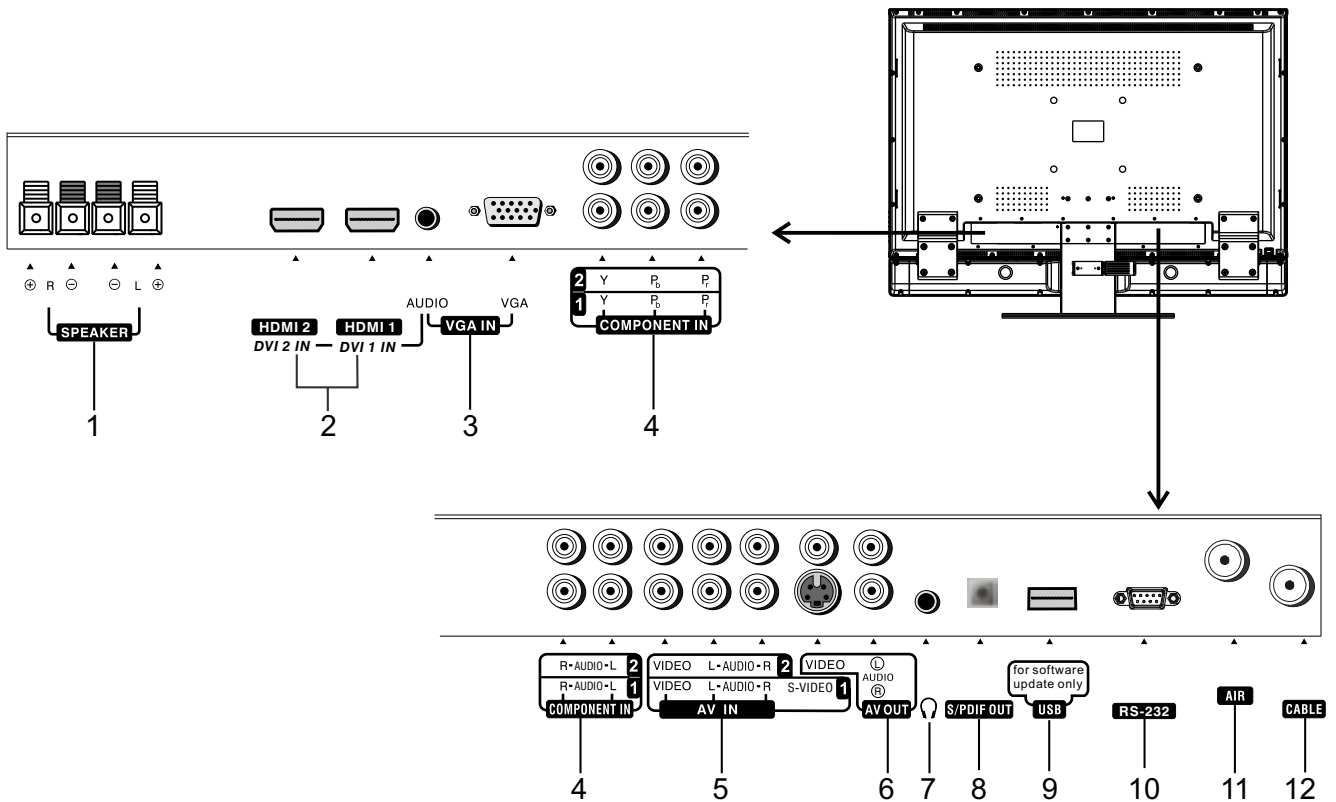

1. Speaker output jacks

2. HDMI/DVI inputs 1/2

To connect with those equipments with HDMI or DVI interface, for example, Set-top box or DVD player.(A HDMI-to-DVI adapter cable is required when you are connecting a DVI-equipped device to this TV.)

3. VGA interface/Audio in

Connect with those equipments with VGA interface, for example, PC.
Connect the audio jack as well with audio cable.

4. Component inputs 1/2

Connect to the audio and component output jacks of a DVD player or Set-top box.

5. AV inputs 1/2

Receive video/audio signals from external sources such as VCR or DVD player.

6. AV output

Connect to the VCR input jacks to record programs.

7. Headphone jack

8. S/PDIF digital audio out terminal (optical)

9. USB port

For software update only. The user can not operate the unit through the USB port.

10. RS-232 control interface

For service only. The user should not use this interface.

11. AIR antenna input

Connect to outdoor antenna.

12. CABLE input

Connect to a cable TV system.

Identification of Controls

Remote Control

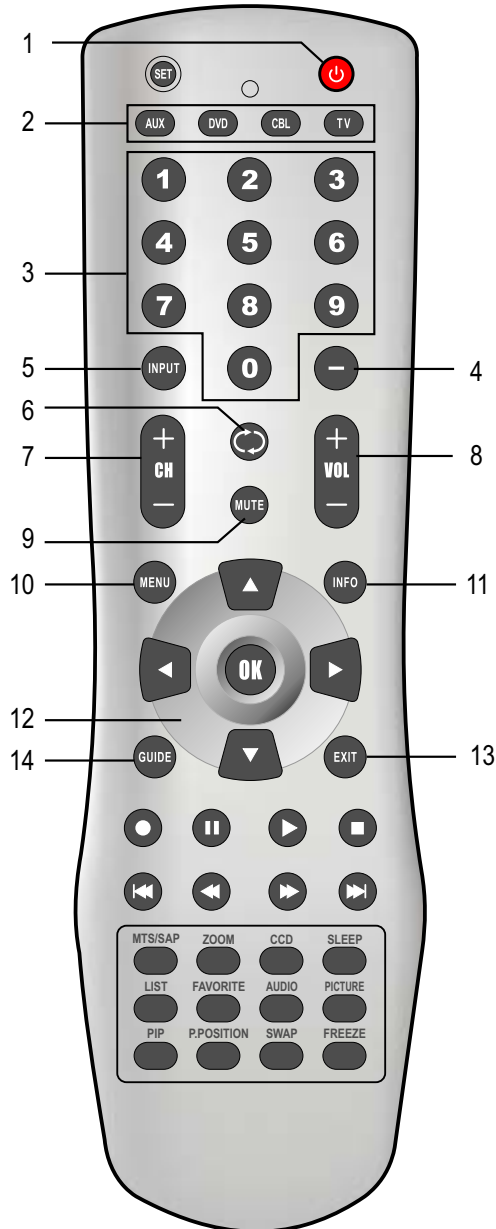

1. POWER

Turn the unit on or off

2. To select additional products to be controlled with remote control

Note: This remote control is an universal remote control. If your remote control does not work correctly when you operate the unit, please try to press TV button.

3. Direct channel selector/number buttons

Use these number buttons to select channel or input password.

4. Dash(-)

Used to enter a program number for multiple program channels such as 2-1,2-2, etc.

5. INPUT

To quickly select input source

6. RETURN

To quickly return to the previous channel

7. CH+/-

To select channels upward or downward

8. VOL+/-

Used to adjust volume.

9. MUTE

Sound mute

10. MENU

To access the Menu main page

11. INFO

To display channel status or signal information

12. Menu navigation buttons:

  : To move upward or downward in menu operation;

  : To move left or right in menu operation;

To adjust selected menu item in menu operation;

OK button: To confirm or toggle between the settings of the selected menu item.

13. EXIT

Used to exit the menu

14. GUIDE

To display the on-screen Electronic Program Guide(EPG)

Identification of Controls

Remote Control



15. ZOOM

To select screen aspect ratio

16. CCD

To select closed caption mode

17.MTS/SAP

To select STEREO, SAP or MONO (Analog TV mode)

To select audio track (DTV mode)

18.SLEEP

To set Sleep timer

19.LIST

To display program list

20.PICTURE

To select the picture mode

21. FAVORITE

To display favorite program list

22. AUDIO

To select the sound mode

23. PIP

To select PIP/PBP/POP/full screen mode

24. FREEZE

To freeze current picture

25. P.POSITION

To select PIP sub picture position

26.SWAP

To swap the main and sub pictures
(only in PIP or PBP mode)

Note: the buttons without description are not active.

Connections

Cautions before connecting

- Carefully check the terminals for position and type before making any connections.
- The illustration of the external equipment may be different depending on your model.
- Loose connectors can result in image or color problems. Make sure that all connectors are securely inserted into their terminals. Refer to the user manual of the external device as well.
- When connecting an external device, turn the power off on the panel to avoid any issues.

Connect an Audio Processor or Hi-Fi (Digital Audio)

For a full Home Theater sound experience, you must connect your Hi-Fi or Audio processor to the S/PDIF OUT(Optical) terminal on the TV rear.

Note:

The S/PDIF OUT terminal only can output digital TV program's audio.

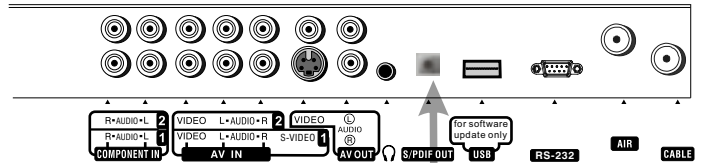

Optical cable

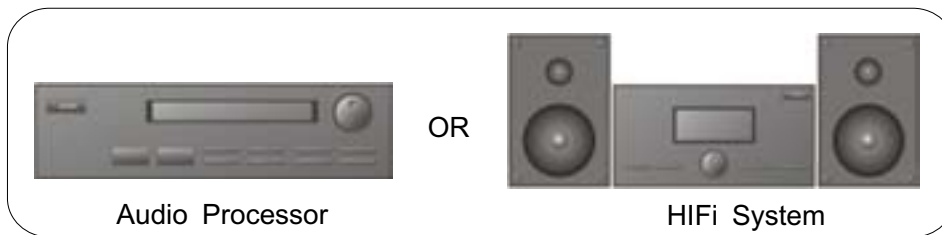

S/PDIF IN
(Optical)

Connect a VCR

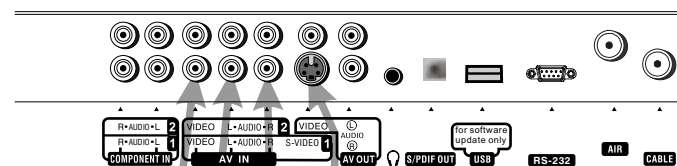

How to connect:

Connect the Audio/Video cables between the Audio (L/R)/Video jacks on the unit and VCR.

Note: For better video, you can use the S-VIDEO terminal if your source supports it. S-VIDEO input uses the same circuit as Video1. S-VIDEO has priority if both connectors are inserted. Use one or the other.

To play VCR

1. Turn on your TV, press **INPUT** button on the remote control to display **INPUT SELECT** menu, use **▲/▼** to select **AV1/SVideo** and then press **OK** to confirm.
2. Turn on your VCR, insert a videotape and press the Play button.

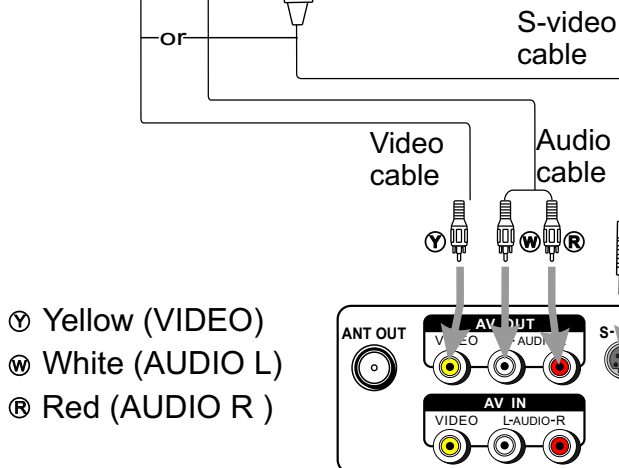

- Ⓜ Yellow (VIDEO)
- Ⓜ White (AUDIO L)
- Ⓜ Red (AUDIO R)

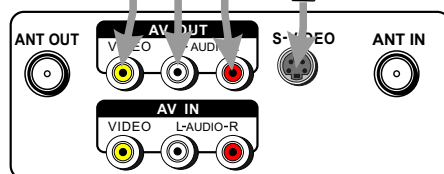

Rear of the VCR

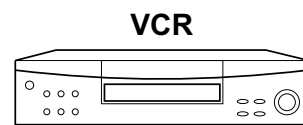

Connections (continued)

Connect a Camcorder

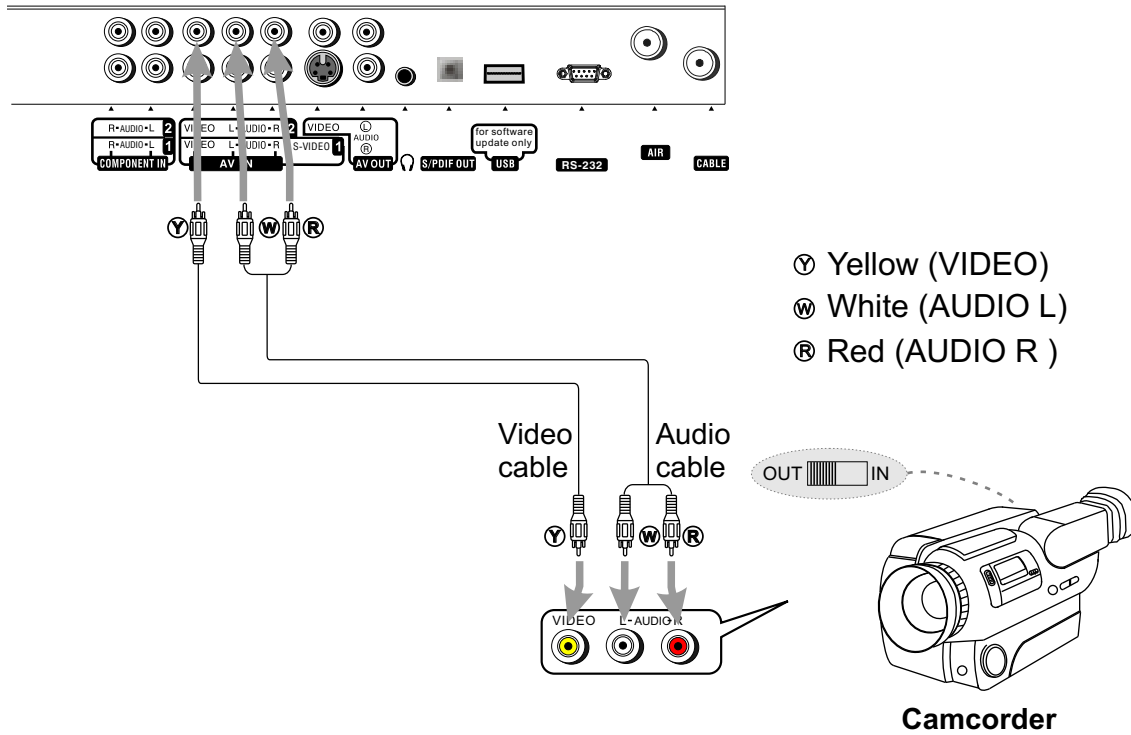

How to connect:

Connect the Audio/Video cables between the Audio (L/R)/Video jacks on the unit and camcorder.

To playback Camcorder

1. Turn on your TV, press **INPUT** button on the remote control to display **INPUT SELECT** menu, use **▲/▼** to select **AV2** and then press **OK** to confirm .
2. Turn on your camcorder and set it to output mode. (For details, refer to your camcorder user manual.)
3. Insert the tape into the camcorder and press Play button.

Note:

The operations of the camcorder may be different and is dependant on your model. Please read the user manual of your camcorder to confirm operation.

Connections (continued)

HDMI Connection

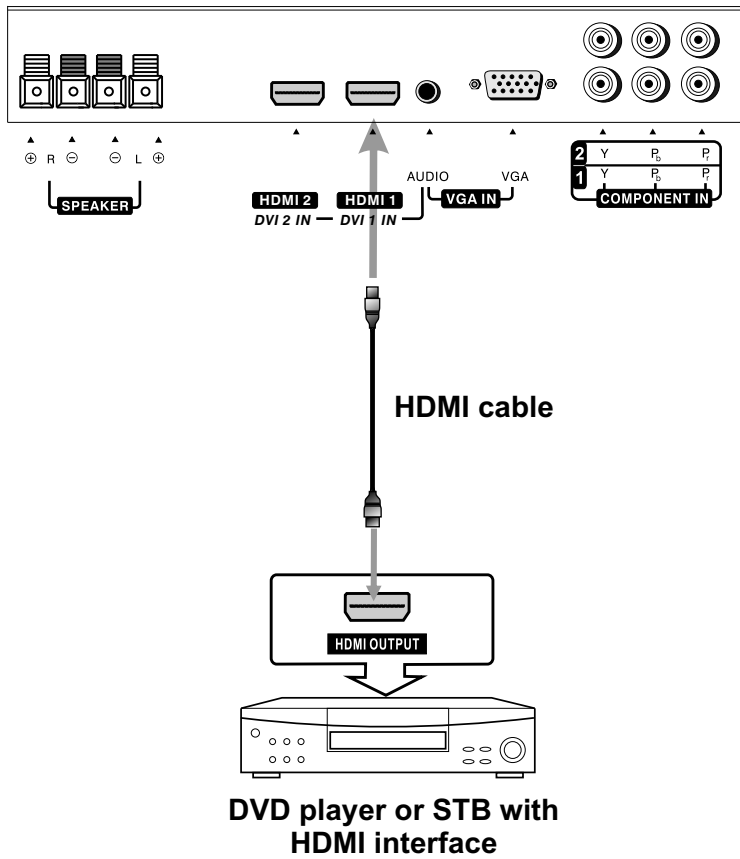

How to connect a DVD Player (or STB) using HDMI Connection:

Connect the HDMI cable between the HDMI interface on the unit and HDMI output on the DVD player (or STB).

To playback DVD (or STB)

1. Turn on your TV, press **INPUT** button on the remote control to display **INPUT SELECT** menu, use \blacktriangle / \blacktriangledown to select **HDMI1** (or select **HDMI2** if **HDMI2** interface is used) and then press **OK** to confirm.
2. Turn on your DVD player or STB and do relative operations.

Note:

If the external device has DVI output only, use a DVI to HDMI adapter cable to connect to the HDMI terminal. Connect the audio cable to the AUDIO terminal of VGA IN on the TV rear.

Connections (continued)

Connect a DVD player or Set-Top Box

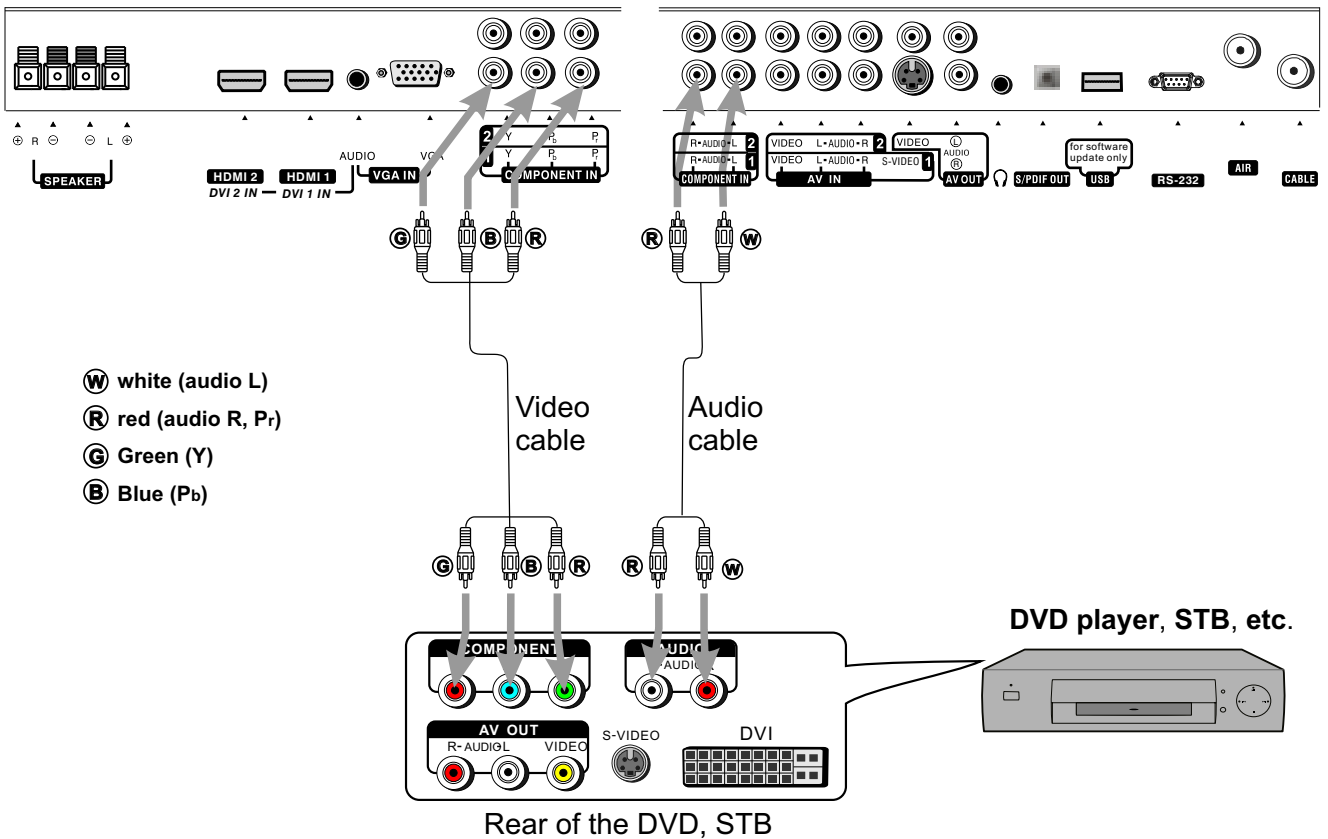

How to connect:

Connect the Video cable between the Y, Pb, Pr input jacks on the unit and Y, Pb, Pr output jacks on the DVD (or STB). Component color inputs provide luminance and separate color signal.

Connect the Audio cable between the AUDIO input jack on the unit and AUDIO output jacks on the DVD (or STB).

To playback DVD or STB

1. Turn on your TV, press **INPUT** button on the remote control to display **INPUT SELECT** menu, use **▲/▼** to select **Component1** (or select **Component2** if COMPONENT2 input terminals are used) and then press **OK** to confirm.
2. Turn on your DVD or STB and do relative operations.

Connections (continued)

Connect a PC

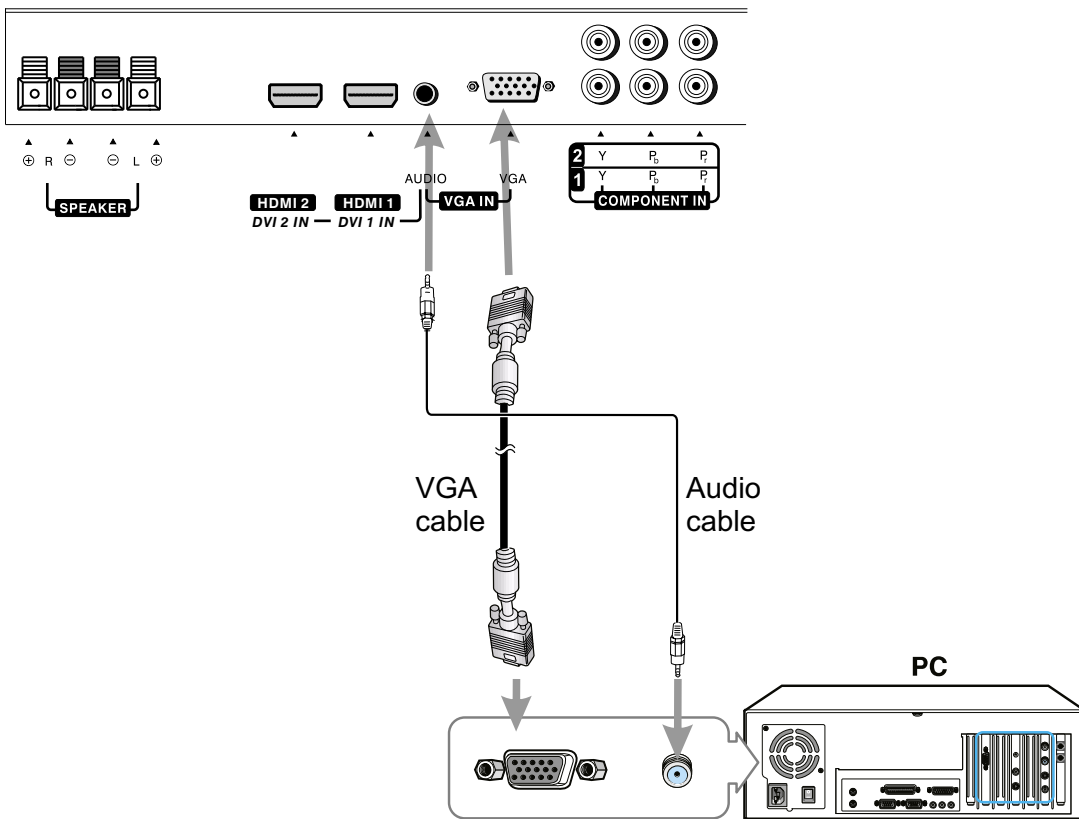

How to connect:

Connect a VGA cable between the VGA(D-sub) interface on the PC and the VGA input interface on the unit.
Connect an Audio cable between the AUDIO output on the PC and AUDIO input jack on the unit.

To Watch the PC screen

1. Turn on your TV, press **INPUT** button on the remote control to display **INPUT SELECT** menu, use **▲/▼** to select **Analog RGB** and then press **OK** to confirm.
2. Turn on your PC and check for PC system requirements.
3. Adjust the PC screen.

Connections (continued)

Connect a VCR (for recording) or external amplifier

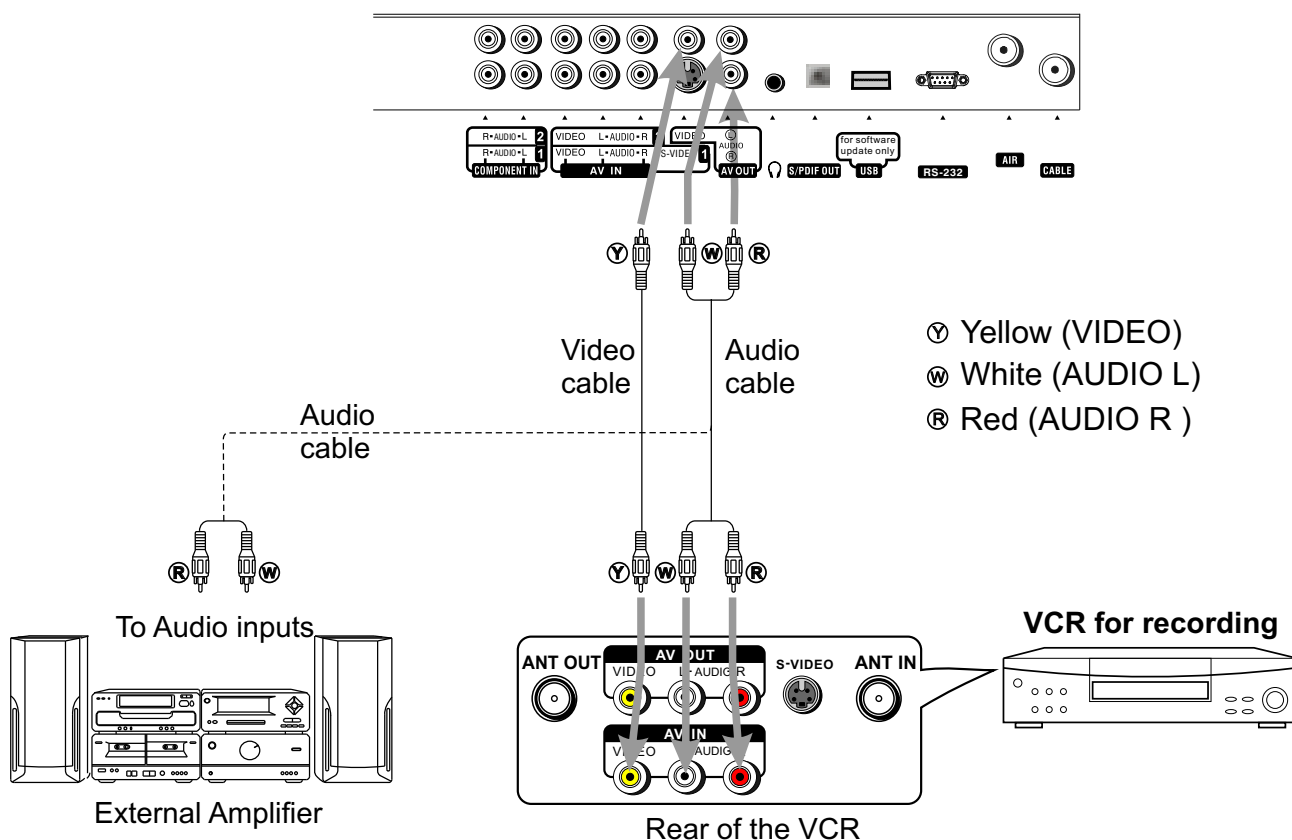

How to connect:

Connect the Audio/Video cables between the Audio (L/R)/Video jacks on the unit and VCR.



Connect the Audio cables between the Audio (L/R) jacks on the unit and external amplifier.

To record program

1. Turn on your TV, select a program you wish to record.
2. Turn on your VCR, insert a videotape for recording.
3. Press the Record button to begin recording.

To enjoy high-quality sound through an external amplifier

Note:

The operations of the amplifier may be different depending on model. Please read the user manual of your amplifier to confirm proper operation.

Only analog TV programs, AV1 and AV2 input sources can be output through the AV output jacks.

Basic Operations

Turning the Unit On and Off

Turning On

Insert the power cord into the wall outlet.

Press the **Power** ⏻ button on the remote control, the unit will be turned on and you will be ready to use its features.

Turning Off

With the power on, press the **Power** ⏻ button on the remote control to turn off.

Note: You can also use the **Power** ⏻ button on the control panel on the main unit.
The period between Turn-Off and Turn-On should be more than 3 seconds.

Viewing the Menus and Displays

This unit has a simple, easy-to-use menu system that appears on the screen. This system makes it convenient and fast to use features on the unit. The unit also lets you display the status of many of your TV features.

Main Menu Overview

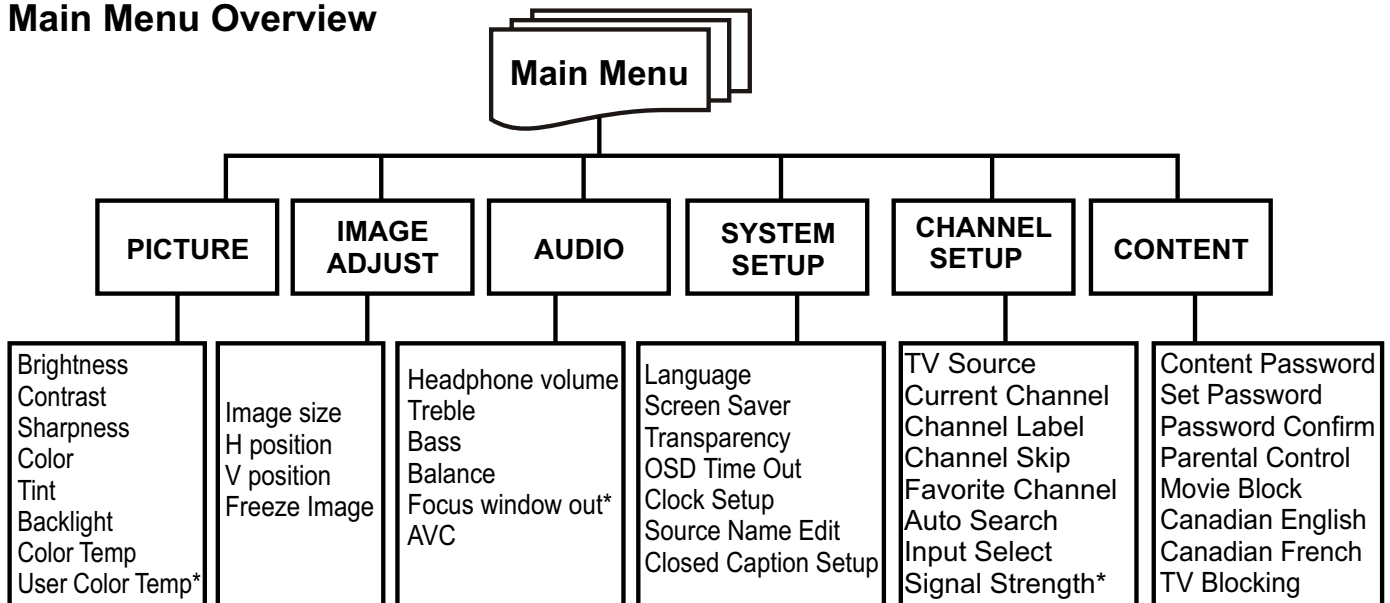

Note:

- The above main menu is illustrated as in TV mode.
- In DTV mode, there is no H position and V position item in IMAGE ADJUST menu.
- Only in DTV mode it will appear Signal Strength bar in CHANNEL SETUP menu.
- The menu items marked with * will appear only on some conditions. In CONTENT menu, 'Content Password' menu item will not be displayed after you use the password to access the menu.

Menu navigation

- 1 With the power on, press the **MENU** button to display the main menu.
- 2 Press **▶** or **◀** button to select menu page.
- 3 Press **▼** button to enter the menu page.
- 4 Within the menu, use **▼** or **▲** to select, use **◀** or **▶** to adjust or enter sub-menu.
In some situations, press **OK** button to confirm or toggle some settings.
- 5 Press **MENU** button to return to the previous level menu.
Press **EXIT** button to exit the main menu and return to your program.

Note:

- To clearly introduce the menu operations, this operation manual provides a description based on operation with the remote control.
- The illustrations and on-screen displays in this manual are for explanation purposes (some are enlarged, others cropped) and may vary slightly from the actual ones.

Basic Operations

On-screen Menus Language Selection

The menus can be shown on the screen in the selected language. First select your language.

- 1 Press **MENU** and then use **▶** or **◀** to display **SYSTEM SETUP** menu page, press **▼** to enter.
- 2 Press **▼** or **▲** to select **Language** item, press **◀** or **▶** to select your desired language.
- 3 Press **EXIT** button to return to TV viewing.

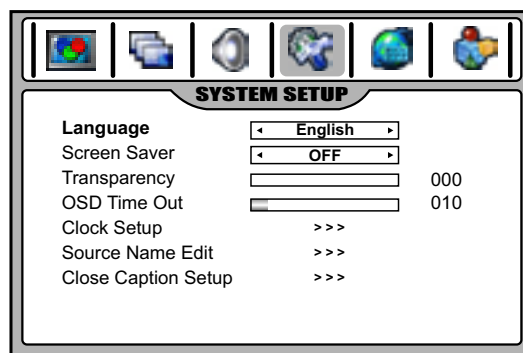

Selecting Input Source Signal

- 1 Press the **INPUT** button to display **INPUT SELECT** menu.
- 2 Press **▼** or **▲** to select your desired input source, press **OK** to confirm.
- 3 Press **INPUT** button to clear the screen.

TV -----Select TV signal.

AV1/SVideo-----Select signal from AV INPUT1/S-VIDEO terminals.

AV2-----Select signal from AV INPUT2 terminals.

Component1-----Select signal from COMPONENT INPUT1 terminals.

Component2-----Select signal from COMPONENT INPUT2 terminals.

Analog RGB-----Select signal from VGA input interface.

HDMI1-----Select signal from HDMI1 input interface.

HDMI2-----Select signal from HDMI2 input interface.

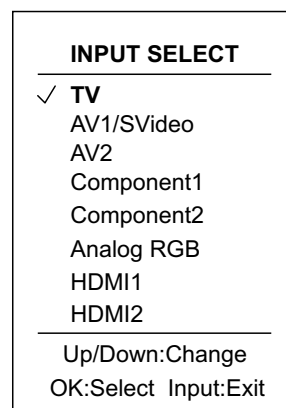

Note:

- You may also make use of OSD main menu (**CHANNEL SETUP** menu) to select the input source.
- You can edit source name to your preference (refer to "**System Setup**" section).

Information Banner

You can press **INFO** button to call up information banner. The information banner will display current status information such as channel number or signal source, etc.

In DTV mode, it will display the following information:

- Channel number and name.
- Air or Cable.
- Resolution.
- Current time.
- Caption icon (if closed caption is turned on), Clock icon (if timer has been setup).
- Current program broadcast progress.
- Current program start and end play times.

Note:

Some DTV programs' information banner may not contain all the above information. It will vary depending on the broadcaster and your setting.

Memorizing the Channels

When the TV powers on for the first time after purchase, the initial auto channel search is invoked.

This unit can automatically find all channels available through antenna or cable inputs, and store them in memory.

Note: Be sure to select the TV input (refer to <Selecting Input Source Signal> section on previous page) before operation.

Selecting the TV Source

Before your TV can memorize the available channels, you must specify the type of signal source that is connected to the unit. (i.e., an antenna or cable system)

- 1 In full screen mode, press **MENU** to display the main menu.
- 2 Press **▶** or **◀** to display **CHANNEL SETUP** menu page, press **▼** to enter.
- 3 Press **▼** or **▲** to select **TV Source** item, press **◀** or **▶** to select **AIR** or **CABLE**.

- Select **AIR** if using antenna.
- Select **CABLE** if using cable.

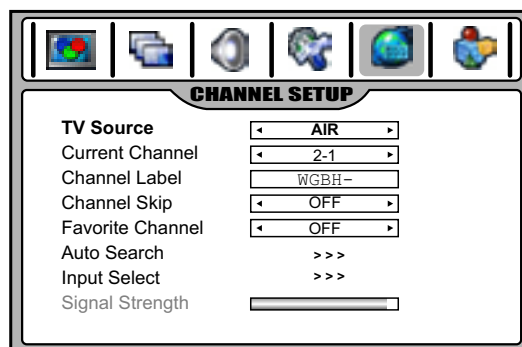

Auto Channel Search

If TV Source is set to AIR: highlight **Auto Search** in the **CHANNEL SETUP** menu and then press **▶** or **◀** to begin the auto channel search, the unit will automatically search for all available TV/DTV program.

If TV Source is set to CABLE: highlight **Auto Search** in the **CHANNEL SETUP** menu and then press **▶** or **◀**, now a **Channel Scan Source** window opens up. Use **▶** or **◀** to select one of **STD**, **HRC**, **IRC** and then press **OK** to begin the auto channel search, the unit will automatically search for all available CATV/CADTV program.

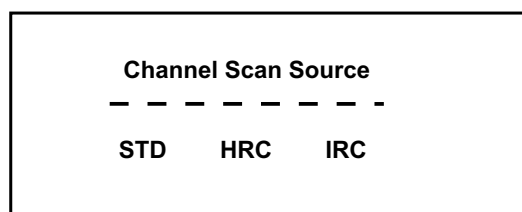
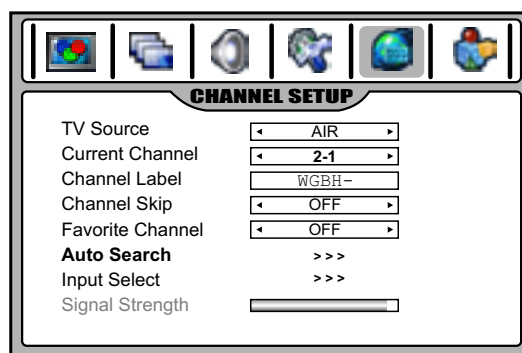

Note:

- If you want to stop the auto-search, press **MENU** button.
- Select one of Cable STD/HRC/IRC according to your local area's cable system, **normally please select STD**.

Channel Skip

After setting channels into memory, you can skip unnecessary channels so that only the channels you want to watch are selected with Channel up/down buttons.

- 1 Navigate to the **CHANNEL SETUP** menu.
- 2 Highlight **Current Channel** item, use **◀** or **▶** to select an unwanted channel.
- 3 Highlight **Channel Skip** item, use **◀** or **▶** to set **ON**.
- 4 If you want to skip other unwanted channels, repeat the above steps.
- 5 Press **EXIT** button to exit.

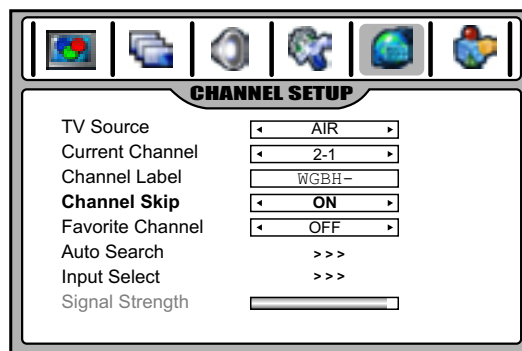

Now when you use **CH+/-** buttons to cycle among the channels, the skipped channels can not be selected.

Memorizing the Channels (continued)

DTV Signal Strength

You can make use of DTV signal strength bar to check how strong your DTV signal is and whether you need to adjust your antenna or digital cable input. The stronger the signal strength, the less likely you are to experience picture degradation.

Navigate to the **CHANNEL SETUP** menu, at the bottom of the menu screen the **Signal Strength** bar is displayed indicating the level and quality of signal that is received by the unit for the current DTV channel.

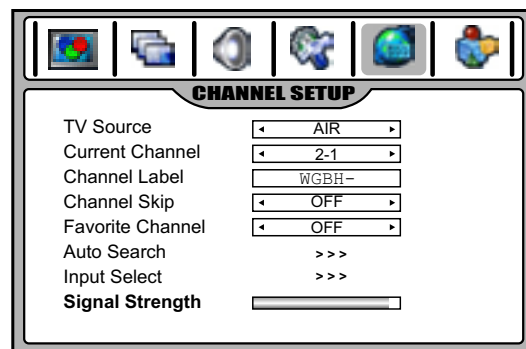

Channel Label Setup

If required, you can give a name to the programs. (Only for analog channels)

- 1 Navigate to the **CHANNEL SETUP** menu and highlight **Channel Label**.
- 2 Press **OK** to enter into channel label editing mode. Use **◀ / ▶** to move the cursor, use **▲ / ▼** to select character. Press **MENU** to exit the editing mode.
- 3 Press **EXIT** button to return to TV viewing.

Note: the names of digital broadcasting channels are automatically assigned and thus cannot be assigned by users.

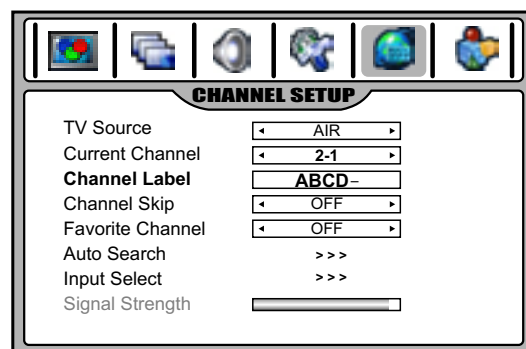

Favorite Channel Setup

You can create a favorite channel list into memory as follows:

- 1 Navigate to the **CHANNEL SETUP** menu.
- 2 Highlight **Current Channel** item, use **◀** or **▶** to select your favorite channel.
- 3 Highlight **Favorite Channel** item, use **◀** or **▶** to select **ON**.
- 4 Repeat the above steps to set more favorite channels (up to 10 channels)
- 5 Now a favorite channel list is created, and you can make use of it to quickly select your favorite channel. Press **FAVORITE** button to call up the Favorite channel list, use **▲ / ▼** to highlight the channel, use **OK** to select that channel.

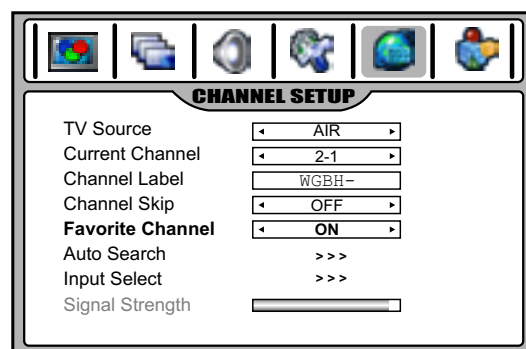

Channel Selection

Information about USA channel numbering

- ATSC PSIP channel has two part channel number:

- Major channel number
- Minor channel number

For example: Channel: 5-1
Major channel number ↑ Minor channel number ↑

- In US, in most situations the major channel number is same for both analog and digital channels (It is equal to the NTSC channel number for existing broadcasters.)
- In US, a minor channel number of zero is used for a broadcaster's analog channel.

Channel Numbering Example

- Original NTSC Channels for Des Moines:
 - 5, 8, 11, 13, 17
- Possible NTSC + ATSC Channels for Des Moines:
 - 5-0, 8-0, 11-0, 13-0, 17-0 (channel numbers for existing analog channels)
 - 5-1, 5-2, 8-1, 8-2, 8-3, 8-4, 13-1 (channel numbers for digital channels)

Channel Selection

Using the Channel up/down buttons (CH+ or CH-)

Press the **CH+** or **CH-** to cycle among available channels found (while the skipped channels can not be selected)

Using the direct select buttons (0-9 and dash buttons)

Press the **number buttons (0-9)** and the **dash (-)** button, and the unit goes to that channel.

For example, if you want to select channel 8-3, just key in '8', '-', '3' on the remote control. (Be sure the period of two-press should be within 3 seconds)

Note:

- When you use the number buttons, you can directly select any channel within the channel range.
- In some situations virtual channel numbers have no correspondence to physical frequencies.
- To select an analog channel, you may directly input its major channel number. It is unnecessary to input the minor channel number of zero.

Using the LAST button

Press this button to switch between the current channel and the last viewed channel.

Using the PROGRAM LIST or FAVORITE LIST

After auto-search, a default program list has been created. You may press **LIST** button to call up the **PROGRAM LIST**, then make use of ▲/▼ to highlight the channel, and then press **OK** to select.

If you have created your favorite program list, you may press **FAVORITE** button to call up the **FAVORITE LIST**, then make use of ▲/▼ to highlight the channel, and then press **OK** to select.

- Note:** 1) In twin window mode, then the above list is only for main window.
2) The OSD illustrations shown on the right are only served as an example and may differ from the actual ones.

PROGRAM LIST	
Digital 2-1	WGBH-SD
Digital 2-2	PBS-HD
Analog 6-0	
Analog 7-0	

FAVORITE LIST	
Digital	2-1
Digital	2-3
Analog	12-0
Analog	48-0

Setting Picture

Customizing the Picture

- 1 Press **MENU** to display the main menu.
- 2 Press **◀** or **▶** to display **PICTURE** menu page, press **▼** to enter.
- 3 Within the menu, use **▲** or **▼** to select item, use **◀** or **▶** to adjust. When **Color Temp** is set to **User**, then you can enter into **User Color Temp** sub-menu to customize the color temperature.
- 4 Press **EXIT** button to return to TV viewing.

Notes:

The OSD illustrations shown on the right are PICTURE menu in TV mode.

The menu items may be different when the unit works in different mode.

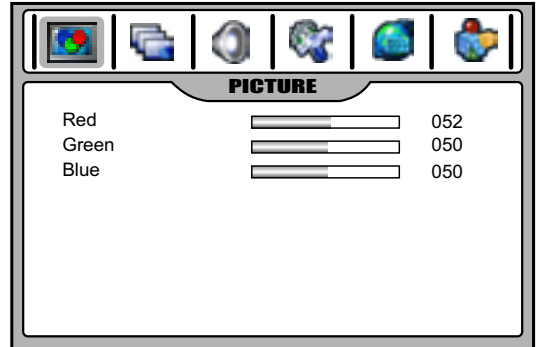
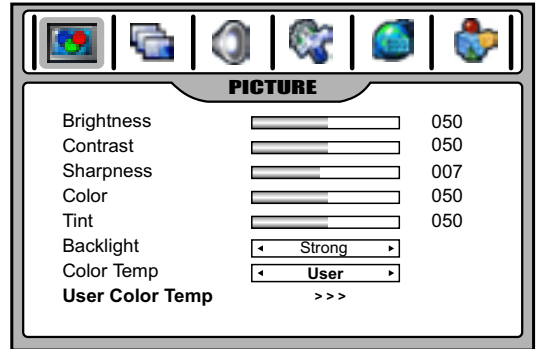

Option	Function	Choice/remarks
Brightness	Adjusts screen brightness for easier viewing of dark picture such as night scenes and black hair.	▶ : lighter ◀ : darker
Contrast	Adjusts image contrast.	▶ : stronger ◀ : weaker
Sharpness	Adjusts image sharpness and displays a sharp image.	▶ : sharper ◀ : softer
Color	Adjusts color saturation.	▶ : stronger ◀ : weaker
Tint	Adjusts tint for image.	▶ : greenish ◀ : purplish
Backlight	Adjusts panel backlight brightness.	Strong/Weak/Medium
Color Temperature	Adjusts the color temperature of the image. Sets to warm to enhance hotter colors such as red, or set to cool to see less intense colors with more blue.	Cool/Warm/User
User Color Temperature	Red	Adjusts the color RED of the image.
	Green	Adjusts the color GREEN of the image.
	Blue	Adjusts the color BLUE of the image.

Setting Picture/Adjusting Image

Picture Mode Selection

You can select the picture quality instantly among three preset modes and one user-set mode.

Press the **PICTURE** button repeatedly to select the desired picture quality. **NATURE**, **SOFT**, **USER** and **BRIGHT** can be selected cyclically.

NATURE: Select for a normal picture.

SOFT: Select for a finely detailed picture.

BRIGHT: Select for a bright picture.

USER: The picture quality you set.

Image Size Adjustment

You can make use of image size adjustment to choose the aspect ratio depending on the format of the received signal and your preference.

Press the **ZOOM** button repeatedly to select the desired image size. You can also adjust **Image size** in the **IMAGE ADJUST** menu.

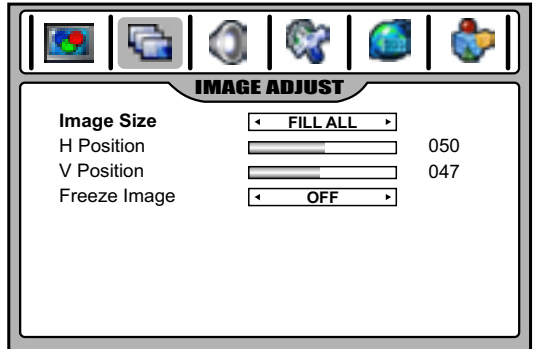

- **NORMAL**

Selects the proper picture proportion to match the source's image. (4:3→4:3, 16:9 → 16:9)

- **WIDE**

This mode stretches the picture horizontally and at the same time still maintains a good aspect ratio at the center of the screen.

- **ZOOM**

This mode enlarges the picture in correct proportion.

- **FILLALL**

This mode displays a picture at full screen size.

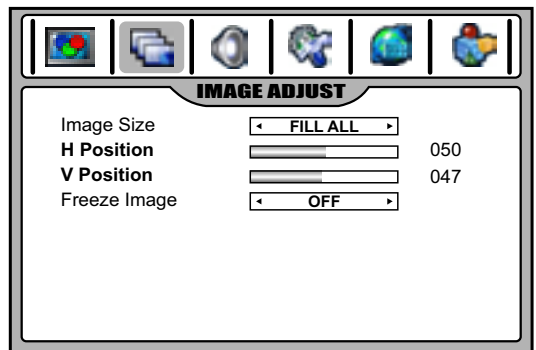

Screen Position Adjustment

- 1 Navigate to the **IMAGE ADJUST** menu.
- 2 Highlight **H Position** or **V Position** item, use ◀ or ▶ to make appropriate adjustments.

Note:

- You may perform screen position adjustment only for analog channels. It is unnecessary to adjust screen position for digital channels.

To Freeze the Picture

Press the **FREEZE** button to freeze the image on the screen (the video sources still run). Press again to restore. You can also set **Freeze Image** to **ON** in the **IMAGE ADJUST** menu to freeze the picture. To restore, set it to **OFF**.

Note:

If a fixed image is displayed on the screen for a long time, that fixed image may become imprinted on the screen and remain visible.

Setting Sound

Adjusting the Volume

Using the volume buttons (VOL+ and VOL-)

Press the **VOL +** or **VOL-** to increase or decrease the volume.

Using the Mute

At any time, you can temporarily cut off the sound using the **MUTE** button. Press the **MUTE** button again to restore.

Customizing the sound

- 1 Press **MENU** to display the main menu.
- 2 Press **◀** or **▶** to display **AUDIO** menu page, press **▼** to enter.
- 3 Within the menu, use **▲** or **▼** to select item, use **◀** or **▶** to adjust.
- 4 Press **EXIT** button to return to TV viewing.

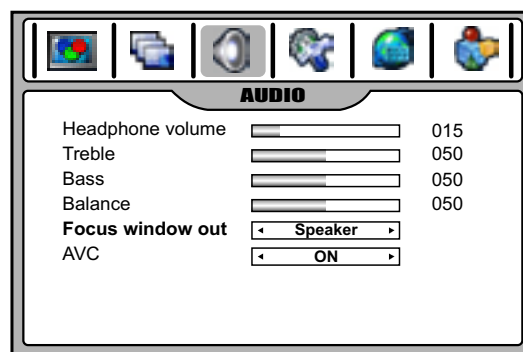

Option	Function	Choice/Remarks
Headphone volume	Adjusts headphone volume.	▶ : stronger ◀ : weaker
Treble	Adjusts Treble (high sounds).	▶ : stronger ◀ : weaker
Bass	Adjusts Bass (low sounds)	▶ : stronger ◀ : weaker
Balance	Adjusts volume balance (left and right volumes).	▶ :Higher volume from right speaker. ◀ :Higher volume from left speaker.
Focus window out (PIP or PBP mode only)	<ul style="list-style-type: none"> • In twin window mode(PIP or PBP), if "speaker" is selected, then the focus window* sound is output from speakers while the other window sound is output from headphone. (Default setting) • If "Headphone" is selected, then the focus window sound is output from headphone while the other window sound is output from speakers. • If "Both" is selected, then both speakers and headphone output focus window sound(as for the other window, this menu item will be set to "None" automatically). 	Speaker/Headphone/Both
AVC (auto volume control)	Each broadcasting station has its own signal conditions, which can make it necessary to adjust the volume every time the channel is changed. Turning "AVC" On lets you automatically adjust the volume of the desired channel by lowering the sound output when the modulation signal is high or by raising the sound output when the modulation signal is low.	ON/OFF

Notes:

- The menu items may be different when the unit works in different mode.
- **Focus Window Out** menu item is available only in twin window mode (PIP or PBP) and either window's program is not in Rating Blocked. If "Both" is selected and later on if either window's program comes into Rating Blocked, the sound may be mute. To cancel, please exit the Rating Blocked state for the program and then set this menu item to other proper choice.
- Normally the main picture is default focus window. You may select sub picture as focus window by pressing **OK** button and a green border will appear on it.

Setting Sound

Sound Mode Selection

You can select the sound quality instantly among three preset modes and one user-set mode.

Press the **AUDIO** button repeatedly to select the desired sound quality. **NEWS**, **USER**, **MOVIE** and **MUSIC** can be selected cyclically.

NEWS: Select for a speech or conversation program.

MOVIE: Select for a movie program.

MUSIC: Select for a music program.

USER: The sound quality you set.

Stereo/SAP Broadcasts Setup (only for analog channel)

- This TV can receive MTS stereo programs and any SAP (Secondary Audio Program) that accompanies the stereo program; if the station transmits an additional sound signal as well as the original one.
- Stereo or SAP can be selected only when the TV station transmits these signals.
- Mono sound is automatically received if the broadcast is only in Mono.
- Select Mono if you are having difficulty receiving a stereo signal.

- 1 When viewing analog channel, press the **MTS/SAP** button to call up the **AUDIO MODE** menu.
- 2 Press **▲** or **▼** to select your desired MTS mode: **Mono**, **Stereo** or **SAP**, then press **OK** to confirm.

Note: In multi window mode, Stereo or SAP can be selected only for main picture.

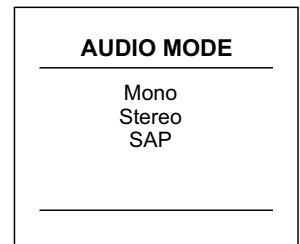

Digital Audio Mode Selection (only in DTV mode)

- The digital-TV transmission system is capable of simultaneous transmission of many audio tracks (for example, simultaneous translations of the program into foreign languages).
- The availability of these additional "multitracks" depends upon the program.

- 1 When viewing digital channel, press the **MTS/SAP** button to call up the **AUDIO MODE** menu.
- 2 Press **▲** or **▼** to select your desired audio mode option, then press **OK** to confirm.

Note: In multi window mode, the MTS/SAP button only can be used for the main picture.

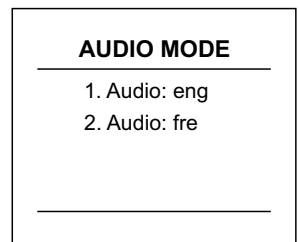

(The above OSD is only served as an illustration. It may be different in different situation)

System Setup

- You may change systems such as OSD language, screen saver, menu transparency, etc. by making use of SYSTEM SETUP menu.

- 1 Press **MENU** and then use ◀ or ▶ to display **SYSTEM SETUP** menu page, press ▼ to enter.
- 2 Within the menu, use ▼ or ▲ to select, use ◀ or ▶ to adjust or enter sub-menu.
In some situations, press **OK** button to confirm or toggle some settings.
- 3 Press **EXIT** button to return to TV viewing.

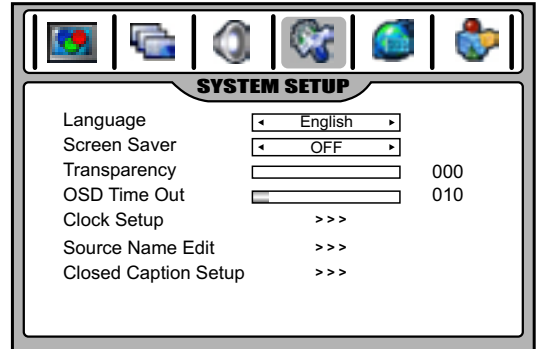

Option	Function
Language	Selects on-screen menus language.
Screen Saver	With the Screen Saver function on, the TV will appear “No Signal” character as screen saver automatically when no signal is being received for some seconds.
Transparency	Adjusts menu transparency.
OSD Time Out	Selects OSD main menu displaying time.
Clock Setup	Making use of Clock Setup sub-menu to setup auto clock, or manual clock, and On/Off timer.
Source Name Edit	Making use of Source Name Edit sub-menu to edit source name for your personal preference.
Closed Caption Setup	Making use of Closed Caption Setup sub-menu to control closed caption, to select caption mode. For DTV program, you can customize the captions that appear on the screen.

Source Name Edit

Name the device connected to the input jacks to make your input source selection easier.

- 1 Navigate to **SYSTEM SETUP** menu and highlight **Source Name Edit**, use ◀ or ▶ to enter.
- 2 Use ▲ or ▼ to select source you want to edit, then press **OK** to enter into source name editing mode.
Use ◀ / ▶ to move the cursor, use ▲ / ▼ to select character.
Press **MENU** to exit the editing mode.

Note: TV source can not be edited.

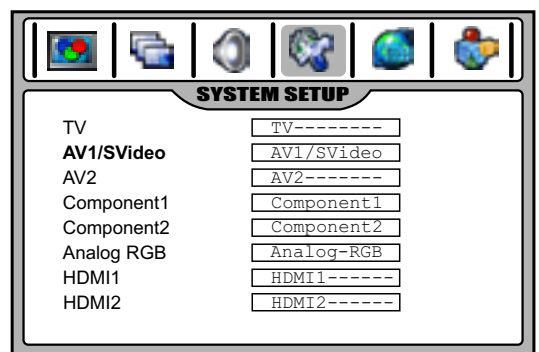

Clock and Timer Setup

Auto Clock Setup

- With the Auto Clock function ON, the time is set automatically from a digital channel signal.
- The digital channel signal includes information for the current time provided by the broadcasting station.
- Set the clock manually, if the current time is set incorrectly by the auto clock function.
- If you cut off the power supply to the TV, the clock setting you have made will be cleared.

1 Press **MENU** and then use ◀ or ▶ to display **SYSTEM SETUP** menu page, press ▼ to enter.

2 Highlight **Clock Setup** item, use ◀ or ▶ to enter.

3 Highlight **Auto Clock** and then use ◀ or ▶ to turn the **Auto Clock** function **ON**.

4 Highlight **Set Time Zone** and then use ◀ or ▶ to select your viewing area time zone: **Atlantic, New Foundland, Samoa, Hawaii, Alaska, Pacific, Mountain, Central, Eastern**.

5 If your viewing area uses Observe Daylight Time, set **Observe Daylight Time** to **ON** in the menu, otherwise set it to **OFF**.

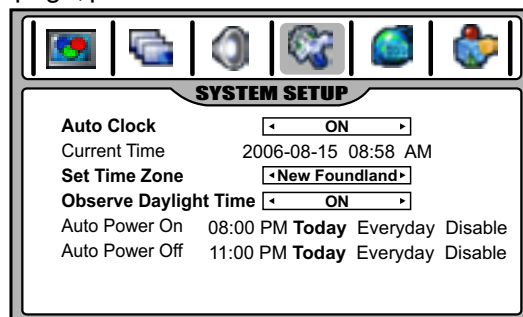

Manual Clock Setup

- If current time setting is wrong, reset the clock manually.
- If you cut off the power supply to the TV, the clock setting you have made will be cleared.

1 Navigate to the **SYSTEM SETUP - Clock Setup** sub-menu, highlight **Auto Clock** and then use ◀ or ▶ to select **OFF**.

2 Press ▲ or ▼ to highlight **Current Time** item and then use ◀ or ▶ to select either the year, date, or time option. Once selected, use the **number buttons** to input and set the year, date and time options. To select **AM** or **PM**, move the cursor to the position and then use **OK** to toggle.

3 If your area uses Observe Daylight Time, set **Observe Daylight Time** to **ON** in the menu, otherwise set it to **OFF**.

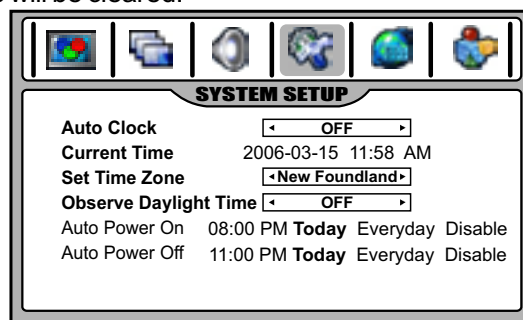

On/Off Timer Setup

- Auto Power On/Off function operates only if current time has been set.
- The TV must be in standby mode for the Auto Power On to work.
- If you cut off the power, the timer setting will be cleared.

1 Navigate to the **SYSTEM SETUP - Clock Setup** sub-menu, highlight **Auto Power On** or **Auto Power Off**.

2 Use ◀ or ▶ to select either the hour or minute option. Once selected, use the **number buttons** to input the time. To select **AM** or **PM**, move the cursor to the position and then use **OK** to toggle.

- If you want the function to work only today, select **Today** and then use **OK** to activate it (displayed in purple).
- If you want the function to work everyday, select **Everyday** and then use **OK** to activate it (displayed in purple).
- To cancel On/Off timer function, select **Disable** and then use **OK** to activate it (displayed in purple).

3 Press **EXIT** button to return to TV viewing or press **MENU** to return to the previous menu.

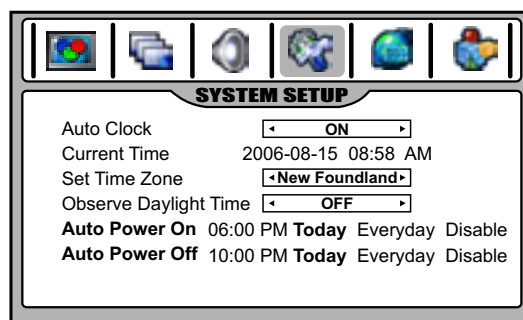

Sleep timer

- Sleep timer lets you select the amount of time before your TV turns itself off automatically. Note that this setting is cleared when the TV is turned off.

Press the **SLEEP** button repeatedly to set sleep timer. To cancel it, press **SLEEP** button repeatedly to select **OFF**.

Viewing Closed Captions

The unit decodes and displays the closed captions that are broadcast with certain TV shows. These captions are usually subtitles for the hearing impaired or foreign language translations. All VCRs record the closed caption signal from television programs, so home-recorded video tapes also provide closed captions. Most prerecorded commercial video tapes provide closed captions as well. Check for the closed caption symbol in your television schedule and on the tape's packaging: .

Note:

The Caption feature only works in TV and AV mode.

Not all the programs and videos will offer closed captioning. Please look for the  symbol to ensure that captions will be shown.

In multi window mode, the Caption feature only applies to main picture.

Closed Caption Control

Press the **CCD** button repeatedly to select Caption **ON**, **MUTE ON**, or **OFF**.

- **MUTE ON** shows the captions (if available on program) when the TV sound is muted.
- You can also navigate to **SYSTEM SETUP-Closed Caption Setup** sub menu and select **Closed Caption Control** item, then use ◀ or ▶ to select Caption **ON**, **MUTE ON**, or **OFF**.

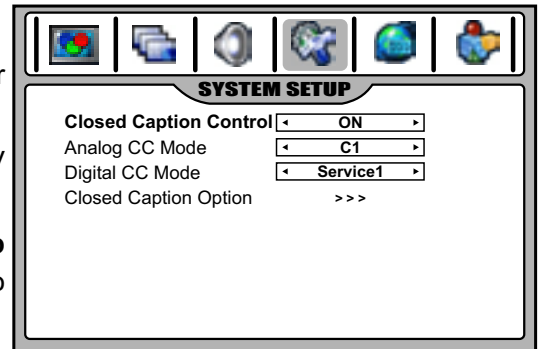

Analog or Digital Broadcasting System Caption Mode

- Select a caption mode for displaying captioning information if provided on a program.
- Analog caption displays information on the screen usually the program's dialog.
- Text displays information, usually at the bottom position and is used for a data service, generally not program related.
- Caption/Text, if provided by the broadcaster, would be available for both digital and analog channels.

- 1 Navigate to **SYSTEM SETUP** menu and highlight **Closed Caption Setup**, use ◀ or ▶ to enter.
- 2 Highlight **Analog CC Mode** or **Digital CC Mode**, use ◀ or ▶ to select caption mode.

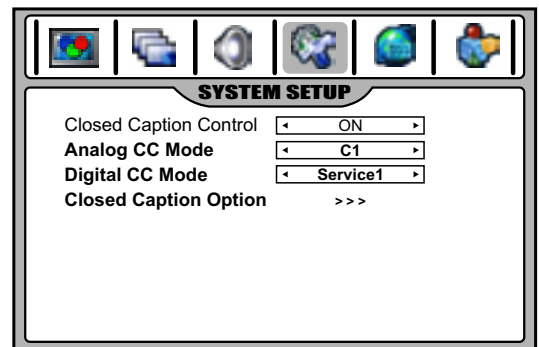

Closed Caption Option

You can customize the digital closed captions that appear on your screen.

- 1 Navigate to the **SYSTEM SETUP** menu and highlight **Closed Caption Setup**, use ◀ or ▶ to enter.
- 2 Highlight **Closed Caption Option**, use ◀ or ▶ to enter.
- 3 Press ▲ or ▼ to select your desired item, and then use ◀ or ▶ to customize the Size, Style, etc. to your preference. A preview sample is provided at the bottom of the menu screen for you to see the effect.

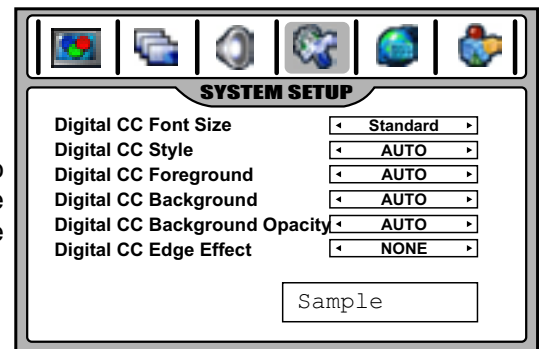

- ◆ **Font Size:** Set the size the words will appear in.
- ◆ **Style:** Select a style for the words.
- ◆ **Foreground:** Select a color for the text.
- ◆ **Background:** Select a background color.
- ◆ **Background Opacity:** Select the opacity for the background color.
- ◆ **Edge Effect:** Select an edge effect.

Setting Parental Control

Parental Control

This function allows TV programs to be restricted and TV usage to be controlled based on FCC data. It prevents children from watching violent or sexual scenes that may be harmful.

Restriction of TV programs includes two ratings that contain information about the program: the MPAA rating and the TV Parental Guidelines. The MPAA rating is restricted by age. TV Parental Guidelines are restricted by age and content.

Since a TV program may use either the MPAA rating or the TV Guidelines, both should be adjusted for complete control.

Note:

The Parental Control function works only in some modes (for example, in TV or AV mode).

If blocked program is selected, then the screen will appear "Rating Blocked".

[1] Movie Rating (MPAA)

Rating		
age based	G	GENERAL AUDIENCES. All ages admitted.
	PG	PARENTAL GUIDANCE SUGGESTED. Some material may not be suitable for children.
	PG13	PARENTAL STRONGLY CAUTIONED. Some material may be inappropriate for children under 13.
	R	RESTRICTED. Under 17 requires accompanying parent or adult guardian.
	NC	NO ONE 17 AND UNDER ADMITTED.
	X	X Rating is an older rating that is unified with NC-17 but may be encoded in the data of older movies.
	NR	NOT RATED.

Note:

The Movie rating is only age-based.

Example:

"PG13" in the age-based rating is blocked, this will automatically block the higher ratings "R", "NC", "X", "NR" also.

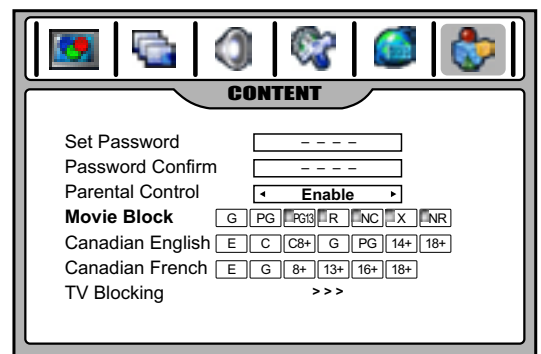

Setting Parental Control(continued)

[2] TV Rating

Rating		← content based →				
		D	L	S	V	FV
age based	Y (All children)	×	×	×	×	×
	Y7 (Direct to Older Children)	×	×	×	×	●
	G (General Audience)	×	×	×	×	
	PG (Parental Guidance Suggested)	●	●	●	●	
	14 (Parents Strongly Cautioned)	●	●	●	●	
	MA (Mature Audience Only)		●	●	●	

× ——— Content Rating can be set but this Rating is not normally broadcast by TV Station.

● ——— Content Rating can be set.

D: Sexually Suggestive Dialog
 L: Adult Language
 S: Sexual Situation
 V: Violence
 FV: Fantasy Violence

Note:

Age-based ratings can be modified by the content-based ratings but only in the combinations indicated by an ● in the table above.

Choosing lower age-based rating blocks the higher age-based ratings regardless of content ratings settings.

Example:

When Y7 in the age-based rating is set to BLOCK, this will automatically block the higher ratings: G, PG, 14 and MA. In addition, D, L, S, V and FV in content are automatically blocked.

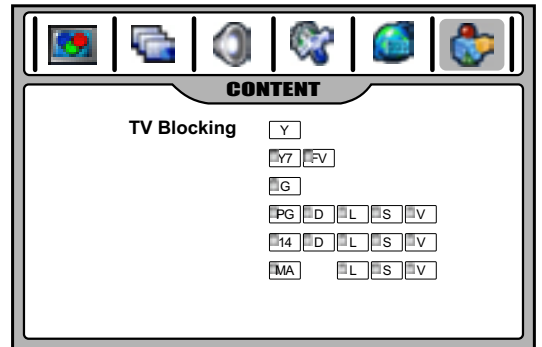

Setting Parental Control(continued)

Password Setup

To use the Parental Control function, you first need to set your password.

- 1 Press **MENU** and then use **◀** or **▶** to display **CONTENT** menu page, press **▼** to enter.
- 2 Enter the password as requested (4-digit, the initial password is 1111). Now the whole CONTENT menu will appear.
- 3 Highlight **Set Password**, enter a new password and then confirm again. Now your new password has been created successfully. **Be sure to write down your password and retain it for future use.**

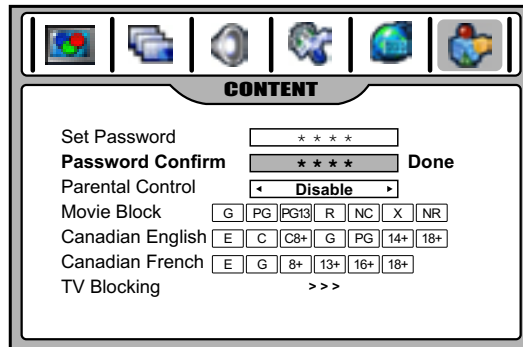

Parental Control Setup

- 1 Use the password to access **CONTENT** menu.
- 2 Highlight **Parental Control**, use **◀** or **▶** to select **Enable** to activate the blocking scheme you set up. If you want to disable the blocking scheme you set up, select **Disable**.

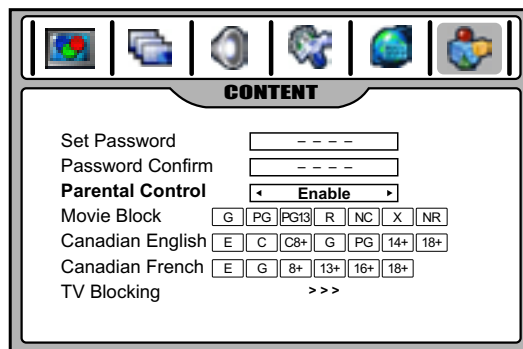

MPAA Rating Setup

- 1 Use the password to access **CONTENT** menu.
- 2 Highlight **Movie Block**, use **◀** or **▶** to select your desired rating, then use **OK** to either block the rating (a lock will appear) or unblock (the lock will disappear). For example, when "PG13" in the age-based rating is blocked, this will automatically block the higher ratings "R", "NC", "X", "NR" also.

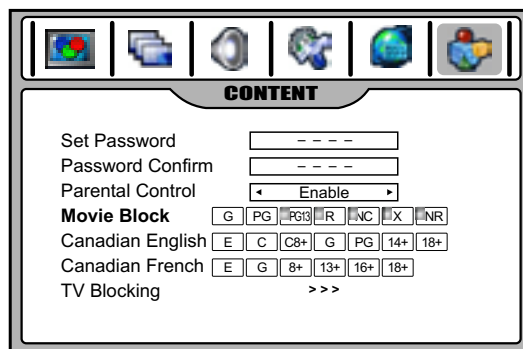

TV Rating Setup

- 1 Use the password to access **CONTENT** menu.
- 2 Highlight **TV Blocking**, use **◀** or **▶** to enter.
- 3 Within the menu, use **▲**, **▼**, **◀** or **▶** to select, use **OK** to either block (a lock will appear) or unblock (the lock will disappear).

For example, when Y7 in the age-based rating is set to BLOCK, this will automatically block the higher ratings: G, PG, 14 and MA. In addition, D, L, S, V and FV in content are automatically blocked.

- 4 Press **EXIT** button to return to TV viewing or press **MENU** to return to the previous menu.

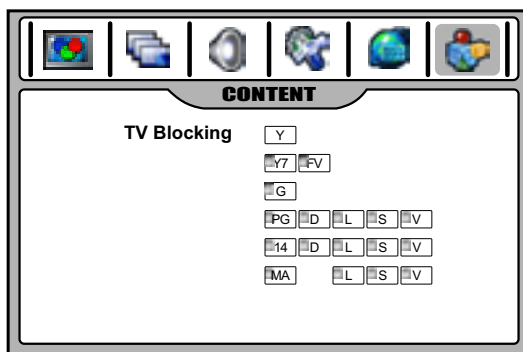

Setting Parental Control(continued)

Canadian English Rating Setup

- 1 Use the password to access **CONTENT** menu.
- 2 Highlight **Canadian English**, use ◀ or ▶ to select your desired rating, then use **OK** to either block the rating (a lock will appear) or unblock (the lock will disappear) .
- 3 Press **EXIT** button to return to TV viewing.

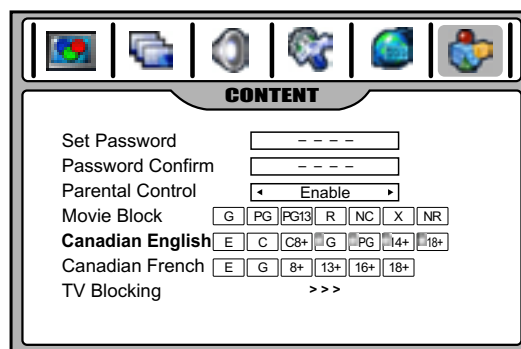

CANADIAN ENGLISH RATING CHART

E	Exempt - Exempt programming includes: news, sports, documentaries and other information programming, talk shows, music videos, and variety programming.
C	Programming intended for children under age 8. No offensive language, nudity or sexual content.
C8+	Programming generally considered acceptable for children 8 years and over. No profanity, nudity or sexual content.
G	General programming, suitable for all audiences.
PG	Parental Guidance suggested. Some material may not be suitable for children.
14+	Programming contains themes or content which may not be suitable for viewers under the age of 14. Parents are strongly cautioned to exercise discretion in permitting viewing by pre-teens and early teens.
18+	Intended for viewers 18 years and older and might contain depictions of violence.

Canadian French Rating Setup

- 1 Use the password to access **CONTENT** menu.
- 2 Highlight **Canadian French**, use ◀ or ▶ to select your desired rating, then use **OK** to either block the rating (a lock will appear) or unblock (the lock will disappear) .
- 3 Press **EXIT** button to return to TV viewing.

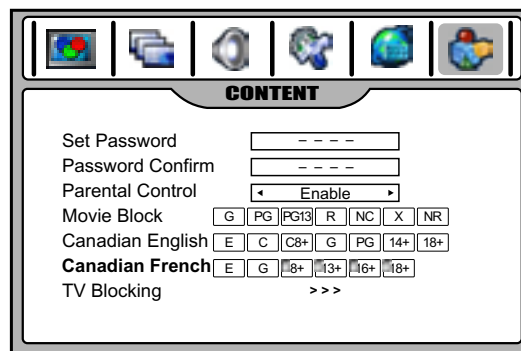

CANADIAN FRENCH RATING CHART

E	Exempt - Exempt programming.
G	General - Programming intended for audience of all ages. Contains no violence, or the violence content is minimal or is depicted appropriately.
8+	8+ General - Not recommended for young children. Programming intended for a broad audience but contains light or occasional violence. Adult supervision recommended.
13+	Programming may not be suitable for children under the age of 13 - Contains either a few violent scenes or one or more sufficiently violent scenes to affect them. Adult supervision strongly suggested.
16+	Programming may not be suitable for children under the age of 16 - Contains frequent scenes of violence or intense violence.
18+	Only for adult viewing. Could contain frequent violent scenes and extreme violence.

Information about RRT5 (Rating Region Table-Region5) criteria rating

If the broadcasting program uses RRT5 criteria rating in accordance with the FCC Rules, this unit can automatically download this kind of rating and provide to user to setup.

Its operation procedures are same to TV rating setup. Use password to access CONTENT menu, at the last line of the menu screen will appear this kind of rating, use ◀ or ▶ to access its first level sub-menu. In this level menu, particular rating types and Reset function are provided. Use menu navigation buttons to select and access second level sub-menu to setup the blocking scheme. Or you may select and activate Reset function at the first level sub-menu to clear the RRT rating. (If this rating is still broadcast by TV station, the unit will download it again).

Note: the actual menu options of this rating will vary depending on the broadcaster.

PIP/PBP/POP Operations

Watching PIP/PBP/POP Picture

Press the **PIP** button (the period of two-press should be within 3 seconds) to select different multi window modes. With each press of **PIP** button, the window mode will cycle among PIP, PBP, POP and full screen mode.

Note: If the period of two-press is more than 3 seconds and when current screen is in multi window mode, press **PIP** button then the screen will directly switch to full screen mode.

Full Screen

In Full Screen mode, only one window appears.

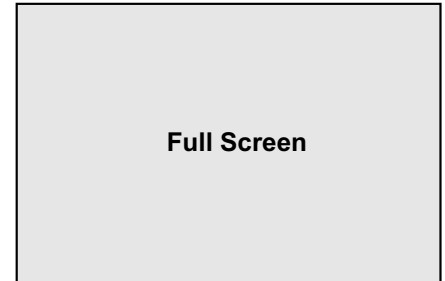

PIP (picture-in-picture)

PIP lets you view two different pictures on your TV screen at the same time. One picture will be large, and the other picture will show a smaller image.

Note: the main picture source can be any one kind except HDMI, while the sub window only can display analog TV channel or AV program.

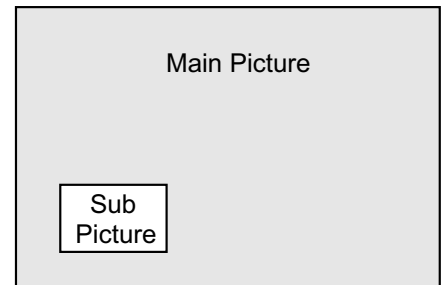

PBP (picture-by-picture)

PBP mode splits the screen into two, allowing two pictures to be shown on the TV screen at the same time. Each picture is given half the screen.

Note: the main picture source can be any one kind except HDMI, while the other window only can display analog TV channel or AV program.

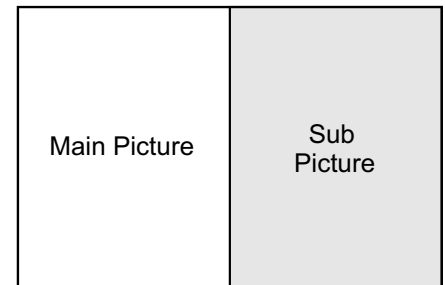

POP (picture-out-of-picture)

Use POP to scan the programs of all the memorized channels one-by-one on the three mini windows (while the main window remains the current program).

Note: the main picture source can be any one kind except HDMI, while the three mini windows only can display analog TV channels.

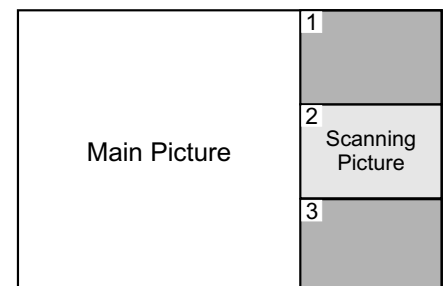

PIP/PBP/POP Operations

Swapping the PIP/PBP Picture

Use the **SWAP** button to swap the main and sub pictures.

Note:

Only when the main picture displays analog TV channel or AV program, the SWAP function can work.

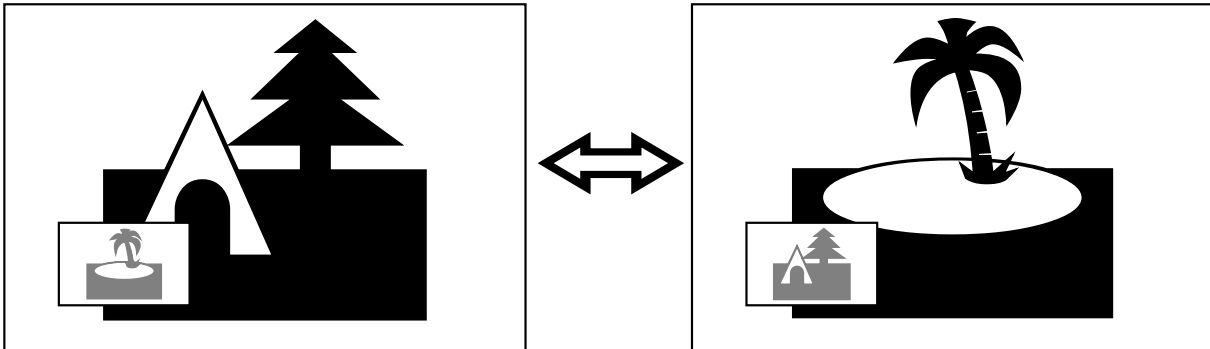

Selecting the PIP sub picture position

In PIP mode, press the **P.POSITION** button to select a different position on the screen for the sub picture.

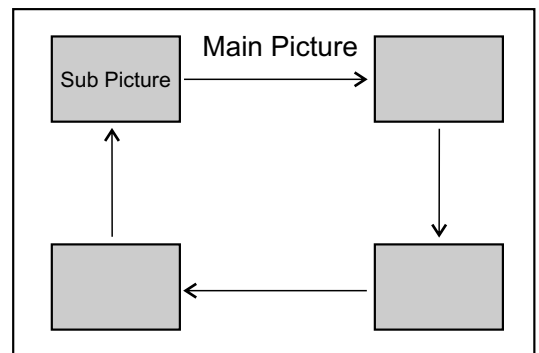

Selecting focus window

In multi window mode, you can press **OK** button to select main or sub picture as focus window and a green border will appear on it. You may apply many operations to the focus window such as channel select, volume control, input source select, etc.

In POP mode, you can press **OK** button to select three mini windows as focus window (1,2,3 will appear for some time). Before 1,2, 3 disappears from the screen you can directly key in 1 or 2 or 3 on the remote control to choose the relevant program to be displayed on the main window.

Note:

- Normally main picture is default focus window.
- Many but not all operations can be applied to focus window.

Electronic Program Guide

Electronic Program Guide

Your TV has an “Electronic Program Guide” to help you to navigate through all the possible viewing options. The EPG supplies information, such as program lists, start and end times of all available channels. In addition, detailed information about the program is often available in the EPG. (The availability and the amount of program details will vary depending on the broadcaster.)

Operation

- 1 To display the Electronic Program Guide, press the **GUIDE** button. An example of an EPG window is given below. To exit, press **GUIDE** button again.
- 2 Press **OK** button to select active window. Once a window is activated, a green border will appear on it and you may apply operations to it.
- 3 If bottom half window of EPG is activated, press **◀** or **▶** button to select your desired channel (once selected, its relevant program information such as program list, start and end times of all available programs will be displayed). Press **▲** or **▼** to select different program at this channel (once selected, the top left window will display detailed information(if available) about this program) .
- 4 If additional and detailed information about the selected program appears on the top left window, you may press **OK** button to highlight it (a green border will appear on it), then use **▲** or **▼** to scroll page (if required) to view more information.

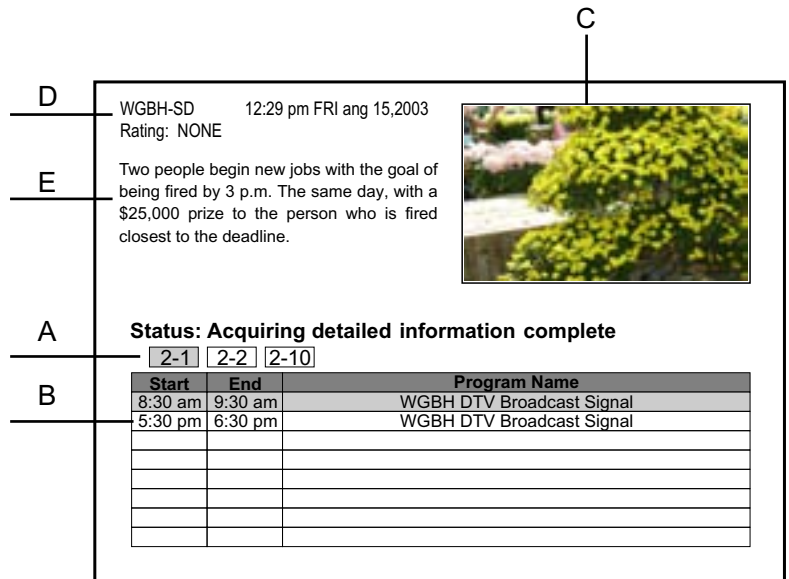

- A** All available sub channels within an ATSC channel will be displayed.
- B** Displays current selected sub-channel's information such as program list, start and end times of all available programs.
- C** Program preview of current selected sub-channel.
- D** Shows current time, date, current program's station and rating, etc.
- E** Displays additional and detailed information about particular program (The availability of additional details depends on the broadcaster).

Note:

- The EPG will only work when you are receiving digital channels.
- To enable EPG to work properly, you must set Auto Clock function to ON.

Image Adjust for PC/Component Mode

- Be sure to select the correct source (Analog RGB or Component) before operation.

Image Adjust

1 Press **MENU** and then use ◀ or ▶ to display **IMAGE ADJUST** menu page, press ▼ to enter.

2 Within the menu, use ▲ or ▼ to select, use ◀ or ▶ to adjust.

3 Press **EXIT** button to exit.

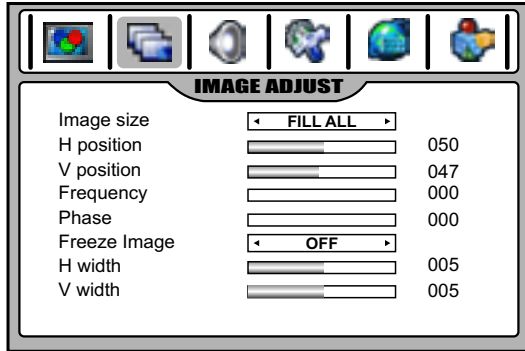

(IMAGE ADJUST menu in **Component** mode)

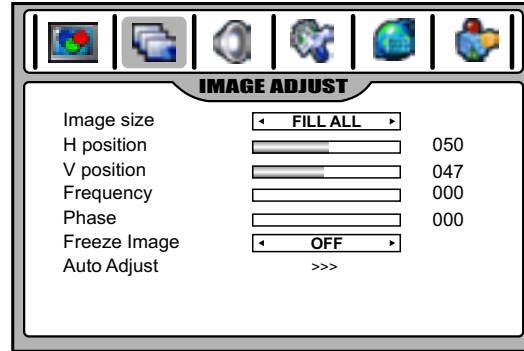

(IMAGE ADJUST menu in **PC** mode)

Option	Function
Image size	Selects a desired image size (aspect ratio). The choice may be different in different mode.(refer to < Setting Picture/Adjusting Image > section in TV mode for details.) Note: you may directly press ZOOM button on the remote control to select.
H position	Move the image on the screen left/right.
V position	Move the image on the screen up/down
Frequency	Adjusts the sample frequency.
Phase	Improves the focussing of stable image.
Freeze Image	Select "ON" to freeze the image on the screen. Select "OFF" to reactivate the image. Note: you may directly press FREEZE button on the remote control to freeze the image, press again to restore.
H width (component mode only)	Adjusts the horizontal width of the image.
V width (component mode only)	Adjusts the vertical width of the image.
Auto Adjust (PC mode only)	Highlight "Auto Adjust" item and then use ◀ or ▶ button to start auto adjustment. The set will automatically adjust the image such as frequency, position setting, etc.

Image Adjust for HDMI Mode

- Be sure to select the HDMI source before operation.

Image Adjust

- 1 Press **MENU** and then use ◀ or ▶ to display **IMAGE ADJUST** menu page, press ▼ to enter.
- 2 Within the menu, use ▲ or ▼ to select, use ◀ or ▶ to adjust.
- 3 Press **EXIT** button to exit.

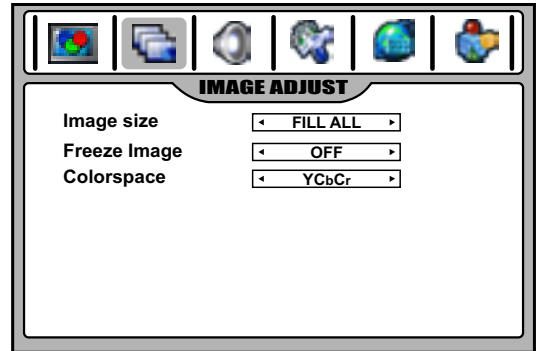

Option	Function
Image size	<p>Selects a desired image size (aspect ratio). (Refer to <Setting Picture/Adjusting Image> section in TV mode for details.)</p> <p>Note: you may directly press ZOOM button on the remote control to select. When 1080i or 1080p signal is received, then this item can not be adjusted.</p>
Freeze Image	<p>Select "ON" to freeze the image on the screen. Select "OFF" to reactivate the image.</p> <p>Note: you may directly press FREEZE button on the remote control to freeze the image, press again to restore.</p>
Colorspace	<p>When the unit converts DVI signal to HDMI signal, sometimes abnormal color will appear, if this situation occurs, you can try to adjust this item.</p>

Troubleshooting

Before calling for repair service, check the following items for possible remedies to an encountered symptom.

Symptoms	Check item
No power	<ul style="list-style-type: none"> • Check that the AC power cord is plugged into the mains socket. • Unplug the power cord, wait for 60 seconds. Then re-insert plug into the mains socket and turn on the unit again.
No picture	<ul style="list-style-type: none"> • Check video connections at the rear of the unit to see if it is properly connected to the unit. • Adjust the contrast and brightness settings. • Select a correct input. • Is a non-compatible signal being input?
Good picture but no sound	<ul style="list-style-type: none"> • Increase the VOLUME. • Check that the unit is not muted.
Good sound but poor color	<ul style="list-style-type: none"> • Adjust the contrast, color and brightness settings.
Poor picture	<ul style="list-style-type: none"> • Sometimes, poor picture quality occurs when an activated S-VHS camera or camcorder is connected while another activated peripheral is connected. In this case, switch off one of the peripherals. • Check whether the room is too bright.
Horizontal dotted line	<ul style="list-style-type: none"> • This may be caused by electrical interference (e.g. hairdryer, nearby neon lights, etc.). • Turn off the equipment.
Remote operation fails.	<ul style="list-style-type: none"> • This remote control is an universal remote control. If the remote control does not work correctly when operating the monitor, try pressing the TV button. • Check whether the batteries are working. Replace if necessary. • Clean the remote control sensor lens on the unit. • Do not use the remote control under strong or fluorescent lighting. • The batteries should be inserted with polarity (+, -) aligned.
Snowy picture and noise	<ul style="list-style-type: none"> • Check the A/V connections.
No stable or not synchronized VGA picture	<ul style="list-style-type: none"> • Check if you have selected the correct VGA mode in your PC.
No output from one of the speakers	<ul style="list-style-type: none"> • Adjust Balance in the AUDIO (SOUND) menu.
Control buttons do not work.	<ul style="list-style-type: none"> • Method 1: Press POWER button on the main unit and wait for 3 seconds, then the main unit will be turned off. Continue to wait for some time and then turn on the unit again. (Recommended because all the setting you have made will not be cleared.) • Method 2: unplug the power cord, wait for a few seconds. Then re-plug the power cord and turn on the unit again. (But all the setting you have made will be cleared.)

Do not use in hot and cold rooms (locations)

- When the unit is used in rooms (locations) with low temperature, the picture may leave trails or appear slightly delayed. This is not a malfunction, and the unit will recover when the temperature returns to normal.
- Do not leave the unit in a hot or cold location. Also, do not leave the unit in a location exposed to direct sunlight or near a heater, as this may cause the cabinet to deform and the LCD panel to malfunction.
(Storage temperature: 0°C to +50°C Working temperature: 5°C to +40°C)

Note:

*If your problem is not solved, turn your unit off and then on again.
Never attempt to repair a defective TV yourself.*

Care and Maintenance

LCD Display panel information

Important Information Regarding Use of Video Games, Computers, Captions or Other Fixed Image Displays.

The extended use of fixed image program material can cause a permanent "shadow image" on the LCD panel.

This background image is viewable on normal programs in the form of a stationary fixed image. This type of irreversible LCD panel deterioration can be limited by observing the following steps:

- A. Reduce the brightness/contrast setting to a minimum viewing level.
- B. Do not display the fixed image for extended periods of time.
- C. Turn the power off when not in actual use.

Note:

The marking or retained image on the LCD panel resulting from fixed image use is not an operating defect and as such is not covered by Warranty. This product is not designed to display fixed image patterns for extended periods of time.

Cleaning and Maintenance

To clean this unit, wipe with a soft, dry cloth.

If the surfaces are extremely dirty, use a soft cloth dipped in a soap and water solution or a weak detergent solution.

- Use eyeglass cleaner to remove stubborn dirt from the LCD.
- Never use alcohol, paint thinner or benzine to clean this unit.
- Before using a chemically treated cloth, read the instructions that came with the cloth carefully.

Specifications

Power supply: AC 100-240V 50/60Hz
Power Consumption: 320W (Max.)
Screen: 47"
Weight: 81.6(lb)
Unit Dimensions (WxHxD)(inch) 45.7 x 35.6 x 10.7

Channel coverage:

VHF	UHF	CATV	CADTV	DTV
2-13	14-69	1-125	1-135	2-69

TV system: NTSC - M, ATSC

Accessories
Operating manual X 1
Remote control unit X 1



- 1. Design and specifications are subject to change without notice.**
- 2. Weight and Dimensions shown are approximate.**
- 3. Specifications and external appearance may be changed for the sake of improvement.**

Programming your Remote Control

Introduction

Your remote lets you control four devices with one easy-to-use, compact unit. After installing batteries, you can program the remote to control your VCR or DVD, Cable or Satellite Receivers, Amplifier or Tuner, and Auxiliary devices. To do so, follow the instructions in "Programming a Device". For best results, please read and follow all the remaining instructions. Keep this guide for future reference.

Note: Programming to control TV is not allowed, TV control is already set and is unchangeable.

A Quick Look at Programming a Device

To control VCR or DVD, Cable or Satellite Receivers, Amplifier or Tuner, and Auxiliary devices, follow these steps. Before proceeding, find the codes for the devices you want to program in "Manufacturer's Codes" in next following pages and write them down or highlight them.

NOTE: To program a DVD Player, portable DVD player, or mobile DVD player, use the **DVD** key.

1. Turn on the device (for example, DVD player) and, if needed, load media (for example, a DVD).
2. Press a device key (**VCR/DVD**, **CBL/ SAT**, or **AUX**).
3. Press and hold **SET** until the red LED blinks twice; then release.
4. Enter the first five-digit code for your device. The LED blinks once as each digit is entered. If the code is correct, the LED blinks twice.
 - **NOTE:** If the LED does not blink twice, repeat steps 2 to 4 and try entering the code again.
5. Aim the remote at the device and press **Power**. The device should turn off. If it does not, repeat steps 3 to 5, trying each code for your brand until you find one that works. If you cannot find a code that works, see "Searching for Your Code".
6. Repeat steps 1 to 5 for the other devices you want to control. For future reference, write down each working device code below:
 - AUX** Code:
 - CBL** Code:
 - CD** Code:
 - DVD** Code:
 - SAT** Code:
 - TNR** Code:
 - VCR** Code:
7. Press set to save and exit

Searching for your Code

If your device does not respond to the remote after trying all codes listed for your brand, or if your brand is not listed, try searching for your code:

1. Press a device key once.
2. Press and hold **SET** until the red LED blinks twice; then release.
3. Enter **9-9-1**, then the device group number (0= Cable, 2= VCR, 3= Audio). The LED blinks twice.
4. Aim the remote at the device and press **Power**. The remote sends IR codes from its library to the selected device, starting with the most popular code first. If the device responds, go to step 7.
5. If the device does not respond, press **CH+**. The remote will try the next code. Continue until the device responds.
 - **NOTE:** Press **CH-** to try the previous code.
6. To search for other device codes, repeat steps 1 to 5.
7. Press **SET** to save and exit.

Checking the Codes

If you have set up the remote using the procedure in "Searching for Your Code", you may need to find out which four-digit code is operating your equipment.

For example, to find out which code is assigned to your DVD:

1. Press **DVD** once.
2. Press and hold **SET** until the red LED blinks twice; then release.
3. Enter **9-9-0**. The LED blinks twice.
4. To view the code for the first digit, press **1**. Count the LED blinks (for example, three blinks = 3), and write down the number in the appropriate code listing in step 6 under "Programming a Device".
 - **NOTE:** If a code digit is **0**, the LED does not blink.
5. Repeat step 4 for the four remaining digits, using **2** for the second digit, **3** for the third digit, **4** for the fourth digit, and **5** for the fifth digit.
6. To check for other device codes, repeat steps 1 to 5, substituting the device key for **DVD**.

Changing Volume Lock

The remote comes preset to allow independent volume control of each selected device (Global Volume Unlock). However, you may change the Volume Lock setting to Global Volume Lock so that one device's volume will control volume in all other modes. After that, you can perform Individual Volume Unlock on a selected device to set its volume control for independent operation or Global Volume Unlock to remove all volume locking.

Locking Volume Control to One Mode (Global Volume Lock)

1. Press and hold **SET** until the red LED blinks twice; then release.
2. Enter **9-9-3** and then press the mode key for the device you want to control volume (for example, **DVD**). The LED blinks twice. Now when you press **VOL+**, **VOL-**, or **Mute**, the selected device (for example, **DVD**) will control the volume regardless of the current mode.

Unlocking All Volume Control (Restoring Global Unlock)

1. Press and hold **SET** until the red LED blinks twice; then release.
2. Enter **9-9-3** and then press **VOL+**. The LED blinks four times.

Volume is now independently controlled for all programmed devices.

Unlocking a Single Device's Volume Control

1. Press a device key (**VCR/DVD**, **CBL/ SAT**, or **AUX**).
2. Press and hold **SET** until the red LED blinks twice; then release.
3. Enter **9-9-3** and then press **VOL-**. The LED blinks four times.

Volume is now independently controlled for the selected devices.

Troubleshooting

PROBLEM: LED does not blink when you press a key.

SOLUTION: Replace with new batteries.

PROBLEM: LED blinks when you press a key, but device does not respond.

SOLUTION: Make sure the remote is aimed at your device and is not more than 15 feet away.

PROBLEM: LED blinks one long blink.

SOLUTION: An entry error has occurred (for example, wrong key). Try entry sequence again.

PROBLEM: Remote does not control devices or commands are not working properly.

SOLUTION: Try all listed codes for the device. Make sure the device operates with an infrared remote control.

PROBLEM: No volume on a device.

SOLUTION: See "Changing Volume Lock".

MANUFACTURER'S CODES

Set Codes for Audio Amplifiers

Bose	30674
GE	30078
JVC	30331
Marantz	30321
Nakamichi	30321
NEC	30264
Optimus	30395
Realistic	30395
Sansui	30321
Shure	30264
Sony	30689
Soundesign	30078
Victor	30331
Wards	30078
Yamaha	30354, 30133

Set Codes for Audio Amp/Tuners

ADC	30531
Aiwa	31405, 31243, 30121
Anam	31609, 31074
Audiotronic	31189
Bose	31229
Capetronic	30531
Carver	31189
Coby	31263
Denon	31360, 31142, 30904
Fonmix	31360
Glory Horse	31263
Harman/Kardon	30110
Hitachi	31273
Inkel	30027
Integra	30135
JBL	30110
JVC	30074, 31263
Kenwood	31313, 31570, 30027
KLH	31428
Magnavox	31189, 31269, 30531
Marantz	31189, 31269, 30039
MCS	30039
Onkyo	30842, 30135
Optimus	31023, 30670, 30531, 31074
Panasonic	31518, 30039
Philips	31189, 31269
Pioneer	31023, 30150, 30014, 30630, 30531
Proscan	31254
Qisheng	31609
Quasar	30039
RadioShack	31263
RCA	31023, 31609, 31254, 30531, 31074
Sharper Image	31263
Silsonic	30176
Sony	31258, 31759
Soundesign	30670
Stereophonics	31023
Sunfire	31313
Teac	31074, 31267
Technics	31308, 31518, 30039
Thorens	31189
Victor	30074
Wards	30014
Yamaha	30176, 31276, 31176

Set Codes for Cable Converters

ABC	00003, 00008, 00014
Americast	00899
Bell & Howell	00014
Bell South	00899
Clearmaster	00883
ClearMax	00883
Coolmax	00883
Daeryung	01877, 00877, 00477, 00008
Digi	00637
Director	00476
Dumont	00637
Gehua	00476
General Instrument	00476, 00810, 00276, 00003, 00014
GoldStar	00144
Hamlin	00009, 00273
Hitachi	00014
Jerrold	00476, 00810, 00276, 00003, 00012, 00014
KNC	00008
LG	00144
Memorex	00000
Motorola	00476, 00810, 00276, 01254, 01376
MultiVision	00012
Pace	01877, 00237
Panasonic	00000, 00008, 00107
Panther	00637
Paragon	00000
Philips	00317, 01305
Pioneer	01877, 00877, 00144, 00533
Pulsar	00000
Quasar	00000
RadioShack	00883
Regal	00279, 00273
Runco	00000
Samsung	00000, 00144
Scientific Atlanta	01877, 00877, 00477, 00008
Sony	01006
Starcom	00003, 00014
Supercable	00276
Supermax	00883
Tocom	00012
Torx	00003
Toshiba	00000
Trans PX	00276
Tristar	00883
TS	00003
V2	00883
Viewmaster	00883
Vision	00883
Vortex View	00883
Zenith	00000, 00525, 00899

Set Codes for CD Players

Aiwa	30157
Burmester	30420
California Audio Labs	30029
Carver	30157, 30179
Denon	30873
DKK	30000
DMX Electronics	30157
Dynamic Bass	30179
Fisher	30179
Garrard	30420
Genexxa	30032
Harman/Kardon	30157, 30173

Hitachi	30032
Integra	30101
JVC	30072
Kenwood	30826, 30626, 30028, 30037, 30036, 30190
Krell	30157
Linn	30157
Magnavox	30157
Marantz	30626, 30029, 30157
MCS	30029
Miro	30000
Mission	30157
MTC	30420
NSM	30157
Onkyo	30868, 30101
Optimus	31063, 30000, 30032, 30037, 30420, 30179, 31075, 30145
Panasonic	30029
Parasound	30420
Philips	30626, 30157
Pioneer	31063, 31062, 30032
Polk Audio	30157
Proton	30157
QED	30157
Quad	30157
Quasar	30029
RadioShack	31075
RCA	31062, 30032, 30420, 30179, 30053
Realistic	30420, 30179
Rotel	30157, 30420
SAE	30157
Sansui	30157
Sanyo	30179
SAST	30157
Sharp	30861, 30037
Silsonic	30888, 30036
Sonic Frontiers	30157
Sony	30490, 30000, 30100
Soundesign	30145
TAG McLaren	30157
Tascam	30420
Teac	30420
Technics	30029
Victor	30072
Wards	30157, 30053
Yamaha	30888, 30036
Zonda	30157

Set Codes for DVD Players

Aiwa	20641, 21912
Akai	20770
Allegro	20869
Apex Digital	20672, 20717, 20797, 21061, 20796, 21056, 21937, 20794, 21020, 21915
Blaupunkt	20717
Blue Parade	20571
Broksonic	20695
Changhong	20627, 21061
CineVision	20869
Coby	21086
Curtis Mathes	21087
CyberHome	21024, 21023, 21129, 20816, 21117
Daewoo	20833, 21172, 20869
Denon	20490
DVD2000	20521
Emerson	20591, 20675

Enterprise	20591
Fisher	21919
Funai	20675
Gateway	21158, 21073
GE	20522, 20717
Go Video	20744, 20833, 21099, 20783, 21075, 20869, 21730
Greenhill	20717
Harman/Kardon	20582, 20702
Hitachi	20573, 20664, 21919
Hiteker	20672
Initial	20717
Integra	20627, 21924
JBL	20702
JVC	20558, 20623, 20867
Kenwood	20490, 20534
KLH	20717, 21020, 21149
Koss	20651, 21980
Lasonic	20798
LG	20591, 20869, 20801
Liquid Video	21980
Lite-On	21158, 21058
Loewe	20511
Magnavox	20503, 20539, 21976, 21914, 20675
Marantz	20539
Memorex	20695
Microsoft	20522
Mintek	20717
Mitsubishi	21521, 20521
Nesa	20717
Norcent	21003
Onkyo	20503, 20627, 21924, 20792
Oritron	20651, 21980
Panasonic	20490, 21762, 21990
Philips	20503, 20539, 20646, 21914
Pioneer	20525, 20571
Polaroid	21086, 21061
Polk Audio	20539
Portland	20770
Proscan	20522
Qwestar	20651
RCA	20522, 20571, 20717, 20822
Rio	20869
Rotel	20623
Sampo	20752, 20698
Samsung	20490, 20573, 21932, 21075, 20820
Sansui	20695
Sanyo	20695
Sharp	20630, 20752
Sharper Image	21117
Sherwood	20770
Shinco	20717
Shinsonic	20533
Sonic Blue	20869, 21099
Sony	20533, 20864, 21033, 21904, 21903
SVA	20717
Sylvania	20675
Symphonic	20675
Teac	20717, 21984, 20809
Technics	20490
Theta Digital	20571
Toshiba	20503, 20695
Urban Concepts	20503
Xbox	20522
Yamaha	20490, 20539, 20545
Zenith	20503, 20591, 20869

Set Codes for Satellite Receivers

AlphaStar	00772
Chaparral	00216
Crossdigital	01109
DirecTV	00392, 00566, 00639, 01142, 00247, 00749, 01749, 00724, 00819, 01856, 01076, 01109, 00099, 01392, 01640, 01442, 01414, 01108
Dish Network System	01005, 00775, 01505
Dishpro	01005, 00775, 01505
Echostar	01005, 00775, 01505
Expressvu	00775
GE	00566
General Instrument	00869
GOI	00775
Goodmans	01246
Hisense	01535
Hitachi	00819, 00222, 01250
HTS	00775
Hughes Network Systems	01142, 00749, 01749, 01442
I-Lo	01535
JVC	00775
LG	01414, 01226
Magnavox	00724, 00722
Memorex	00724
Mitsubishi	00749
Motorola	00869
NEC	01270
Next Level	00869
Panasonic	00247, 00701
Paysat	00724
Philips	01142, 00749, 01749, 00724, 01076, 00722, 00099, 01442
Proscan	00392, 00566
Proton	01535
RadioShack	00869
RCA	00392, 00566, 00855, 00143, 01392
Samsung	01276, 01109, 01108
Sanyo	01219
SKY	00856
Sony	00639, 01640
Star Choice	00869
Tivo	01142, 01442
Toshiba	00749, 01749, 00790, 01285
UltimateTV	01640, 01392
Uniden	00724, 00722
US Digital	01535
USDTV	01535
Voom	00869
Zenith	00856, 01856

Set Codes for VCRs

ABS	21972
Admiral	20048, 20209
Aiko	20278
Aiwa	20037, 20479
Alienware	21972
America Action	20278
American High	20035
Amoisonic	20479
Anam	20162, 20037, 20240, 20278
Anam National	20162
Asha	20240
Audiovox	20037, 20278
Beaumarck	20240
Bell & Howell	20104
Broksonic	20184, 20121, 20209, 20002, 20479
Calix	20037
Canon	20035
Carver	20081
CCE	20072, 20278
Changhong	20048, 20081
Citizen	20037, 20278
Colt	20072
Craig	20037, 20047, 20240, 20072
Curtis Mathes	20060, 20035, 20162
Cybernex	20240
CyberPower	21972
Daewoo	20045, 20104, 20278
Dell	21972
Denon	20042
DirecTV	20739
Durabrand	20039, 20038
Electrohome	20037
Electroponic	20037
Emerex	20032
Emerson	20035, 20037, 20184, 20240, 20045, 20121, 20043, 20209, 20002, 20278, 20479
Fisher	20047, 20104
Fuji	20035, 20033
Fujitsu	20045
Gateway	21972
GE	20060, 20035, 20240
General	20045
Go Video	20432
GoldStar	20037, 20209, 20038, 20225
Haojie	20240
Harman/Kardon	20081, 20038
Harwood	20072
Hewlett Packard	21972
HI-Q	20047
Hitachi	20037, 20042, 20055
Howard Computers	21972
HP	21972
Hughes Network Systems	20042, 20739
iBUYPOWER	21972
JVC	20045, 20067
KEC	20037, 20278
Kenwood	20067, 20038
KLH	20072
Kodak	20035, 20037
Kolin	20043
LG	20037, 20045, 20042, 20209, 20038
Logik	20072
LXI	20037
Magnavox	20035, 20039, 20081
Magnin	20240
Marantz	20035, 20081
Marta	20037

Matsushita	20035, 20162
Media Center PC	21972
MEI	20035
Memorex	20035, 20162, 20037, 20048, 20039, 20047, 20240, 20104, 20209, 20479
MGA	20240, 20043
MGN Technology	20240
Microsoft	21972
Mind	21972
Minolta	20042
Mitsubishi	20067, 20043
Motorola	20035, 20048
MTC	20240
Multitech	20072
NEC	20035, 20037, 20048, 20104, 20067, 20038
Newave	20037
Nikko	20037
Noblex	20240
Northgate	21972
Olympus	20035
Optimus	21062, 20162, 20037, 20048, 20104, 20432
Orion	20184, 20209, 20002, 20479
Panasonic	21062, 20035, 20162, 20616, 20225
Penney	20035, 20037, 20240, 20042, 20038
Pentax	20042
Philco	20035, 20479
Philips	20035, 20081, 20739, 20618
Pilot	20037
Pioneer	20042, 20067
Polk Audio	20081
Profitronic	20240
Proscan	20060
Protec	20072
Pulsar	20039
Qisheng	20060
Quasar	20035, 20162
Radix	20037
Randex	20037
RCA	20060, 20035, 20240, 20042, 20880
Realistic	20035, 20037, 20048, 20047, 20104
ReplayTV	20616
Runco	20039
Sampo	20037, 20048
Samsung	20240, 20045, 20432
Sanky	20048, 20039
Sansui	20067, 20209, 20479
Sanyo	20047, 20240, 20104
Scott	20184, 20045, 20121, 20043
Sears	20035, 20037, 20047, 20042, 20104
Sharp	20048, 20209
Shintom	20072
Shogun	20240
Singer	20072
Sonic Blue	20616
Sony	20035, 20032, 20033, 20636, 21972
STS	20042
Sylvania	20035, 20081, 20043
Systemax	21972
Tagar Systems	21972
Tashiko	20037
Tatung	20045, 20067
Technics	20035, 20162
Teco	20035, 20037, 20048, 20038
Teknika	20035, 20037
Tivo	20636, 20618, 21503, 20739
TMK	20240
Toshiba	20045, 20042, 20067, 20043, 21503, 21008, 21972

Totevision	20037, 20240
Touch	21972
Unitech	20240
Vector	20045
Vector Research	20038
Victor	20067
Video Concepts	20045
Videomagic	20037
Videosonic	20240
Viewsonic	21972
Wards	20060, 20035, 20048, 20047, 20081, 20240, 20042, 20072
White Westinghouse	20209, 20072
XR-1000	20035, 20072
Yamaha	20038
Zenith	20039, 20033, 20209, 20479
ZT Group	21972

CARE

- Keep the remote dry. If it gets wet, wipe it dry immediately.
- Use and store the unit only in normal temperature environments.
- Handle the remote gently and carefully. Don't drop it.
- Wipe the remote with a damp cloth to keep it looking like new.



PRINTED ON
RECYCLED PAPER

604.L47FE277-00
Ver 1.0