

MMD85A

8.5" OVERHEAD LCD MONITOR WITH DVD PLAYER

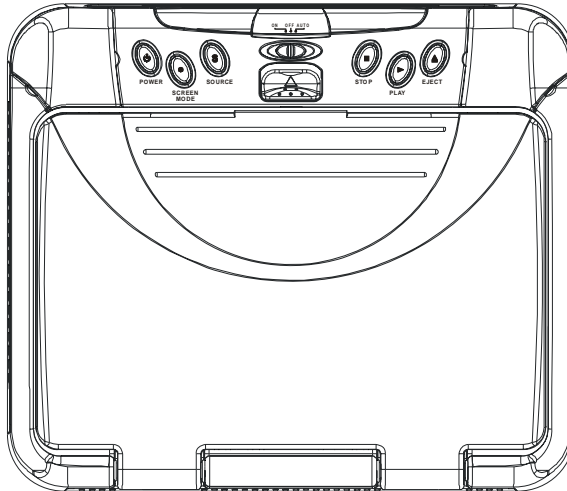

OPERATION MANUAL



128-7460

Important Notice

An LCD panel and/or video monitor may be installed in a motor vehicle and visible to the driver if the LCD panel or video monitor is used for vehicle information, system control, rear or side observation or navigation. If the LCD panel or video monitor is used for television reception, video or DVD play, the LCD panel or video monitor must be installed so that these features will only function when the vehicle is in “park” or when the vehicle’s parking brake is applied.

An LCD panel or video monitor used for television reception, video or DVD play that operates when the vehicle is in gear or when the parking brake is not applied must be installed to the rear of the driver’s seat where it will not be visible, directly or indirectly, to the operator of the motor vehicle.

Warnings

- ◆ Do not use any solvents or cleaning materials when cleaning the video monitor.
- ◆ Do not use any abrasive cleaners, they may scratch the screen.
- ◆ Use only a lightly dampened lint free cloth to wipe the screen if it is dirty.
- ◆ Lock the LCD screen in the fully closed position when not in use.
- ◆ Before putting on headphones always adjust the volume setting to the lowest position.
- ◆ Remember to leave the dome light switch in the off or auto positions when the vehicle is unattended, as the dome lights, if left on, can drain the vehicle’s battery.
- ◆ Do not put pressure on the screen.
- ◆ Caution children to avoid touching or scratching the screen, as it may become dirty or damaged.

Congratulations on your purchase of the Movies 2 Go MMD85A drop-down Video Monitor with DVD Player. The MMD85A has been designed to give you and your family many years of video entertainment in the mobile environment. Please read the directions that follow to familiarize yourself with the product and to ensure that you obtain the best results from your equipment.

NOTE: *Installation options vary, see the individual owner's manuals for each component in your system to obtain a full understanding of each component's operation.*

FEATURES

- ◆ 8.5" TFT (Thin Film Transistor) Active Matrix LCD (Liquid Crystal Display) Monitor
- ◆ OSD (On Screen Display) for Control of Picture Quality and Functions
- ◆ Infrared Transmitter for Optional IR Wireless Headphones
- ◆ Three Audio/ Video Source Inputs (including the Built-in DVD player)
- ◆ Dome Lights with Built-in Three Way Switch
- ◆ Video Display ON/OFF Control (when LCD Panel is Opened and Closed)
- ◆ Last Position Memory for DVD
- ◆ Two Headphone Jacks
- ◆ Screen Mode Select Switch (16:9, 4:3)
- ◆ Full Function Remote Control
- ◆ Backlit Controls for Low Light Operation
- ◆ Built-in Wireless FM Modulator

CONTROLS AND INDICATORS DIAGRAM

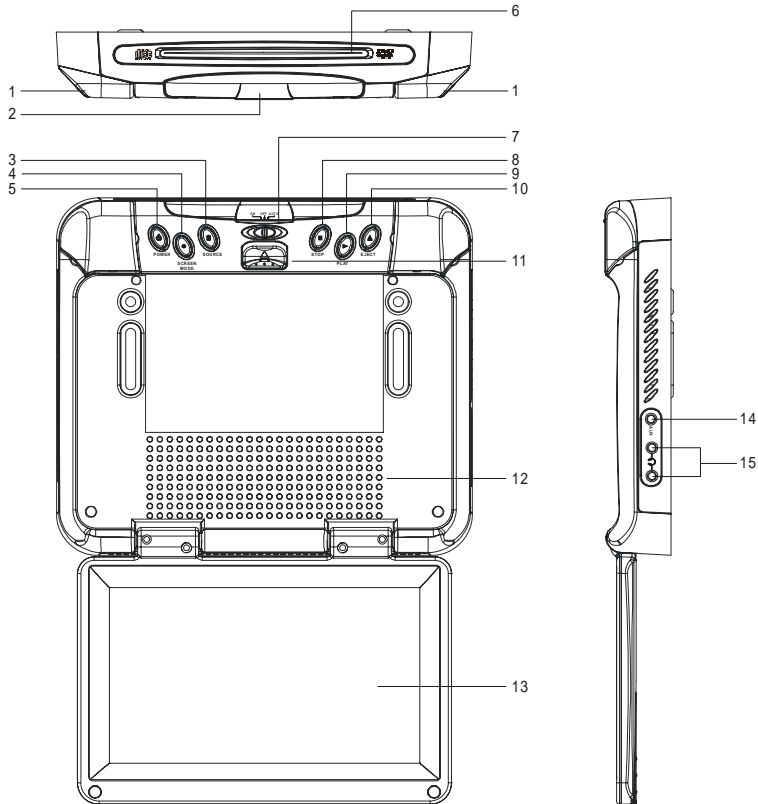

4

MMD85A

MAIN FUNCTION DESCRIPTIONS

1. **Dome Lights** – Provide additional interior illumination.
2. **Infrared Transmitter and Sensor** – Used to transmit audio to wireless headphones. Also allows the remote control to operate the MMD85A and to control other accessories in the system.
3. **Source Button** – Source select DVD, AV1, AUX.
4. **Screen Mode Button (●)** – Allows the user to change screen format (Aspect Ratio 4:3 or 16:9).
5. **Power ON/OFF Button (⏻)** – Turn the MMD85A ON and OFF.
6. **DVD disc insertion slot**
7. **Three Position Dome Light Switch**
 - Auto – Automatically switches on the dome lights in conjunction with the vehicle's interior illumination.
 - Off – The Dome lights will not turn on in this position.
 - On – Turns on the Dome lights.
8. **Stop Button (■)** – This button is used to enter the stop mode.
9. **Play Button (▶)** – This button is used to enter the play mode.
10. **Eject Button (▲)** – This button is used to eject the disc.
11. **Screen Release** – Slides in the direction of the arrow to release the drop down screen.
12. **Ventilation Opening**
13. **LCD Panel** – Display the video source and the On Screen Displays (OSD).
14. **Auxiliary Video/Audio Input** – Audio/Video source input.
15. **Headphone Jacks** – Allows the use of wired headphones with a 1/8" plug for listening to the video program audio.

Remote Control Operation

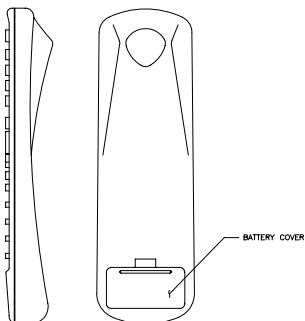

Battery Installation

Before attempting to operate your Remote Control, install the batteries as described below.

- 1) Turn the Remote Control face down. Using a fingernail, lift the battery cover off.
- 2) Install two "AAA" batteries. Make sure that proper polarity (+ or -) is observed.
- 3) Align the cover tabs with the remote control and press until the cover clicks.

The remote control will operate the MMD85A. It is not a universal remote control and will not control equipment from other manufacturers.

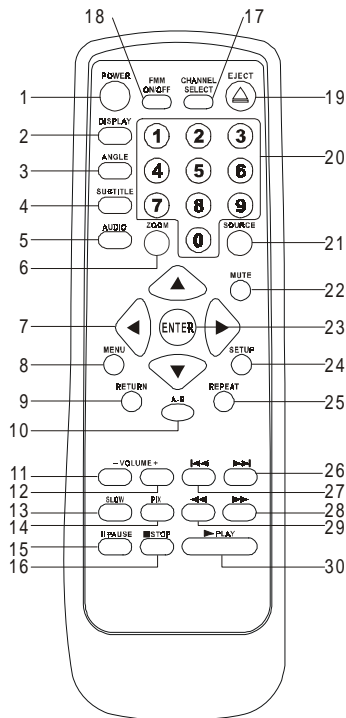

Operation with Remote Control

* Function control is available on the unit and the Remote Control.

1. * **POWER**

Press this button to turn "ON" and "OFF" the MMD85A.

2. **DISPLAY**

Press to display current disc information while the disc is playing. Press cursor (▲▼◀▶) buttons to select from:

Title
Chapter
Angle
Audio
Subtitle

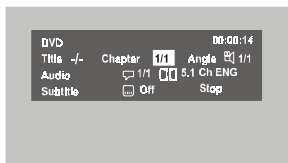

For Title/Chapter, press numeric buttons to do Title/Chapter selection. For Angle, Audio & Subtitle, press the Enter key repeatedly to change the options. These option may vary from disc to disc.

3. **ANGLE**

Press to display and select different camera angles in DVD mode. Each time you press the button, the angle changes.

Note: The numbers of angles vary from disc to disc. Not all discs contain this option

4. **SUBTITLE**

Press to display and select the subtitle language in DVD mode. Each time you press the button, the subtitle language changes.

Note: The type and number of languages for subtitle vary from disc to disc.

5. **AUDIO**

Press to display and select the AUDIO language in DVD mode. Each time you press the button, the language changes.

Note: The languages for audio vary from disc to disc.

6. **ZOOM**

Press this button to zoom the picture when playing a DVD disc.

Press ZOOM button	DVD player perform
Once	Enlarge the picture 2 times the original size
Twice	Enlarge the picture 3 times the original size
3 times	Enlarge the picture 4 times the original size
4 times	Picture is returned to original size

7. **CURSOR (▲▼◀▶)**

Use these buttons to access menu selections on the screen.

8. **MENU**

Allow the user to access the disc menu.

9. **RETURN**

Not used in this model.

10. **A-B**

Allow user to repeat the playback from point A to point B.

Press A-B button	On-Screen Display	DVD player
Once	Repeat A-	Mark beginning of the section to repeat (Set point A)
Twice	Repeat AB	Mark the end of the section to repeat (Set point B)
3 times	AB Off	Deactivate the A-B repeat function

11. **VOLUME DOWN (-)**

Press to decrease the volume level of the headphone jacks. It is also used to make picture adjustments in the picture select mode.

12. VOLUME UP (+)

Press to increase the volume level of the wired headphone jacks. It is also used to make picture adjustments in the picture select mode.

Note: The volume buttons will not affect the volume of wireless headphones or the FM modulator. When using these devices, the volume must be adjusted with the wireless headphone volume control or with your radio's volume control.

Description of the adjustment items when the Volume Up and Volume Down buttons are used in the picture select mode:

Item	Press Volume Down (-) button	Press Volume Up (+) button
CONTRAST	Decrease the contrast	Increase picture contrast
BRIGHTNESS	To darken the picture	To brighten the picture
TINT	Increase the greenish skin tones	Increase the reddish skin tones
COLOR	Decrease the color intensity	Increase the color intensity

13. SLOW

Play a DVD in slow motion

Press **SLOW** button **DVD Player Perform**

Once	Play a disc in slow <i>forward</i> motion with the speed reduced to 1/2 of normal speed
Twice	Play a disc in slow <i>forward</i> motion with the speed reduced to 1/4 of normal speed
3 times	Play a disc in slow <i>forward</i> motion with the speed reduced to 1/6 of normal speed
4 times	Play a disc in slow <i>forward</i> motion with the speed reduced to 1/7 of normal speed
5 times	Play a disc in slow <i>reverse</i> motion with the speed reduced to 1/2 of normal speed
6 times	Play a disc in slow <i>reverse</i> motion with the speed reduced to 1/4 of normal speed
7 times	Play a disc in slow <i>reverse</i> motion with the speed reduced to 1/6 of normal speed
8 times	Play a disc in slow <i>reverse</i> motion with the speed reduced to 1/7 of normal speed
9 times	Return to normal speed

14. **PIX (Picture Select)**

Each time this button is pressed, the on screen picture adjustment displays the “adjustment bar” for BRIGHTNESS, CONTRAST, COLOR or TINT. Once the desired adjustment bar is displayed, use the VOLUME+ / VOLUME- button to adjust the setting. The display will automatically turn off if no adjustments are made within 6 seconds, or is any other button is pressed.

15. **PAUSE (II)**

Press to pause playback

16. *** STOP (■)**

Press to stop playback

17. **CHANNEL SELECT Button**

Selects the FM modulator Frequency (Frequency 1, 88.3MHz, Frequency 2, 88.7MHz, Frequency 3, 89.1MHz, Frequency 4, 89.5MHz, Frequency 5, 89.9MHz)

18. **FMM ON/OFF Button**

Turns the FM Modulator power on/off.

19. **Eject (▲) Button***

This button is used to eject the disc.

20. **NUMBERS**

Allow the user to enter the numbers 0-9 for selection of the tracks, titles, chapters or password setting.

21. *** SOURCE**

Video signals from video equipment connected to the AV1 or AUX inputs can be displayed on the monitor by pressing this button. Each time the button is pressed, the audio/video source will switch between DVD, AV1 and AUX.

22. **MUTE**
Press to mute the audio. Press it again to restore the sound to the previously set level.
23. **ENTER**
Press to implement selected settings.
24. **SETUP**
Press to display the Setup Menu which allows the user to change the DVD player options such as TV DISPLAY, OSD LANGUAGE, EQ TYPE, PARENTAL CONTROL etc. Refer to the settings and Adjustments section for more information.
25. **REPEAT**
Allow the user to repeat the playback in various options. Press repeatedly to change the options.
26. **NEXT (▶▶)**
Press to skip to the next chapter or track
27. **PREVIOUS (◀◀)**
Press to return to the previous chapter or track.
28. **SCAN FORWARD (▶▶▶)**
Press to search in a forward direction. Press repeatedly to change the search speed from 2, 4, 8, 20 times the normal speed.
29. **SCAN BACKWARD (◀◀◀)**
Press to search in a backward direction. Press repeatedly to change the search speed from 2, 4, 8, 20 times the normal speed.
30. ***PLAY**
Press to activate the play mode while a disc is loaded in the disc compartment.

* Function is available on the remote and the front panel.

Settings and Adjustments

The Setup Menu contains features and options that let you customize your DVD player. For example, you can set a language for the on-screen display, limit playback for children, load default settings for the picture quality and DVD players etc.

Using the Setup Menu

1. Press the SETUP button on the remote. The Setup Menu appears on the screen as shown in the diagram.

Language	Language Setup
Video	Video Setup
Rating	Rating Setup

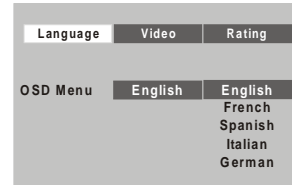

2. In order to go to the desired page, move the highlight using the cursor button ◀ or ▶ to the desired page.
3. After entering the desired page, highlight the desired item using the cursor button ▲ or ▼.
4. Press ▶ to move the highlight to the different options for the selected item. Press ▲ or ▼ to select the desired options, and then press ENTER to confirm the selection.
5. Repeat steps 3-4 to continue setting the items in the same Setup Page.
6. To change to another Setup page, press ◀ until the highlight moves back to the top part of the Setup Menu. Then, repeat steps 2-5.

Exiting the Setup Menu

Press the SETUP button again only.

LANGUAGE SETUP

Language for On-Screen Display

OSD MENU : The OSD MENU setup allows you to select the language for the on-screen display. The user can either select English, French, Spanish, Italian or German for the OSD language.

Language	Video	Rating
OSD Menu	English	English French Spanish Italian German

VIDEO SETUP

TV DISPLAY

The TV DISPLAY setup allows you to adjust screen setting (aspect ratio).

4:3 PS

This displays the wide picture on the screen with a portion of the left & right side removed.

4:3 LB

This displays the wide picture with black bands on the upper and lower portions of the screen.

16:9

This displays a wide picture with black bands on the upper and lower portion of the screen. The bandwidth will vary, depending on the aspect ratio of the disc.

Language	Video	Rating
TV Display	16:9	4:3 PS
TV Type	NTSC	4:3 LB 16:9

TV TYPE

The TV TYPE setup allows you to select the system to fit to the color system of the TV to be connected.

NTSC - Select this type for NTSC TV

PAL - Select this type for PAL TV

MULTI - Select this type for multi-system TV

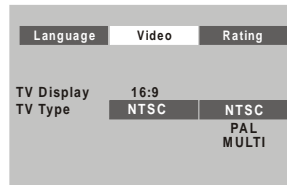

RATING SETUP

PASSWORD

After you selected the password change, use the numeric buttons to key in the default password (3308), then press Enter.

*To lock the parental setting key in the default password or key in a new password. Then press Enter to apply the changes.

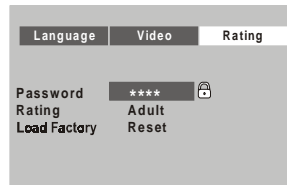

RATING

This item allows you to limit the content of movie playback from G to Adult. The lower the value, the more strict the control.

- G
- PG
- PG – 3
- R
- NC – 17
- Adult

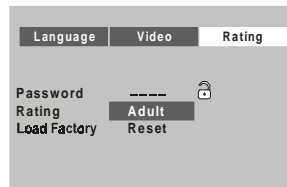

LOAD FACTORY

The Load Factory Reset allows you to reset all options to factory settings.

* This function will not affect the Parental Rating control settings.

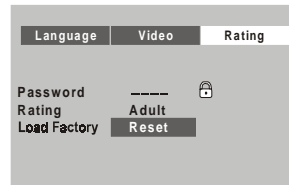

Playing DVDs

1. Press the DISPLAY Button on the remote control to display the status banner.
2. Selecting a chapter.
You can skip to a specific chapter by using the numbers keys. For example, if you want to skip to chapter 2, press "02".
3. Using the Repeat Feature
The default mode for the Repeat feature is OFF. Pressing REPEAT consecutively changes the repeat options :
 - REPEAT CHAPTER — Repeat the chapter that is playing.
 - REPEAT TITLE — Repeat the title that is playing.

Playing Audio CDs

When playing an audio CD, the DISPLAY banner appears automatically. It displays the track and the amount of time for the track playing, the total amount of time on the disc and the elapsed time of the disc.

Selecting a Track

You can skip to a specific track by using the numbers buttons. After choosing the track, press ENTER to implement the selection.

Using the REPEAT feature

The default mode for Repeat feature is OFF. Pressing REPEAT consecutively changes the repeat options:

- SINGLE - repeat the track that is playing
- ALL - repeat the entire disc that is playing

As you toggle through the options, the repeat option changes at that time. The track, for example, repeats once that track has ended. The selected repeat option loops repeatedly until you turn it off.

Playing MP3 Discs

MP3 is a format for storing digital audio. An audio CD-quality song can be compressed into the MP3 format with very little loss of quality, while taking up much less space. CD-R discs that have been encoded in MP3 format can be played on your DVD player. The DVD player plays the songs in the order they were burned on to the disc.

Press DISPLAY button on the remote to display the time counter display elapsed only.

- Time elapsed is the time that the song has played
- Time remaining is the amount of time left for the song being played.

Selecting Folders and Songs

When an MP3 is loaded in the player, the navigation menu appears automatically.

1. Press ▲ or ▼ to move the highlight to the desired folder and press ENTER to display the songs in the folder.
2. Press ▲ or ▼ to move the highlight to the desired song and press ENTER to begin playback of the highlighted song.

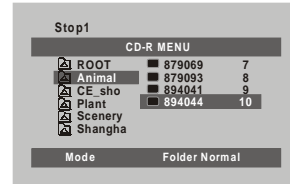

Skipping Songs

Use the Next (▶▶) button on the remote control to move to the next song. Use the Previous (◀◀) button to move to the previous song.

Selecting a Play Mode

You can choose what order the songs will play on a disc temporarily. The default play mode is FOLDER. Press REPEAT consecutively to choose the desired play mode. The play mode options are:

- FOLDER Plays the songs in a folder in the order they were recorded.
- SHUFFLE Plays the songs in a folder in random order (from within the selected folder).
- RANDOM Plays the songs in a folder in random order.
- SINGLE Plays a selected song.
- REPEAT ONE Repeat the song that is playing.
- REPEAT FOLDER Repeat the folder that is playing.

TURNING THE MMD85A ON OR OFF

1. Sliding the screen release lock forward will unlock the LCD screen and it will drop down slightly. Pivot the screen downward until a comfortable viewing angle is reached. The hinge friction will hold the screen in position while the system is in use.
2. Pressing the power button on the unit or the remote control will turn the system on or off alternately. When in use the internal backlighting will illuminate the controls.
3. After the unit has been turned on and is displaying a picture, adjust the viewing angle, by pivoting the screen to optimize the picture quality.
4. Remember to turn the unit off and pivot the LCD to the locked position when not in use.

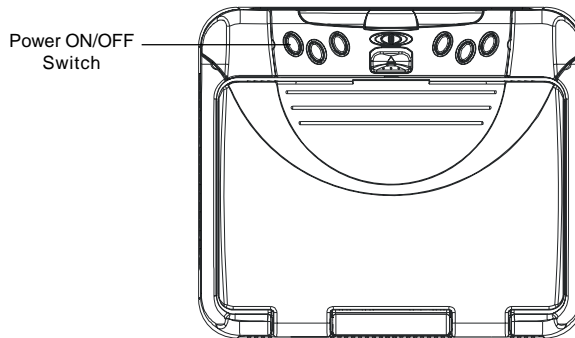

MMD85A

19

OVERHEAD DOME LIGHTS

The Dome Lights integrated into the MMD85A are controlled by a three position slide switch. Sliding the switch to the ON position will turn the lights ON. The OFF position will prevent the lights from turning ON with the vehicle's interior lighting, and the auto position will allow the lights to turn ON and OFF with the vehicle's interior lighting. Refer to the installation Guide for wire connections. Do not leave the vehicle unattended with the dome light switch in the ON position, as this could result in a discharged battery.

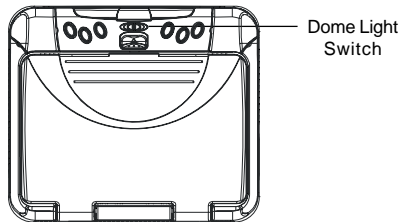

REMOTE SENSOR

The MMD85A incorporates an infrared sensor which relays signals from the remote control to allow the unit to be controlled simply by pointing its remote control at the remote sensor eye.

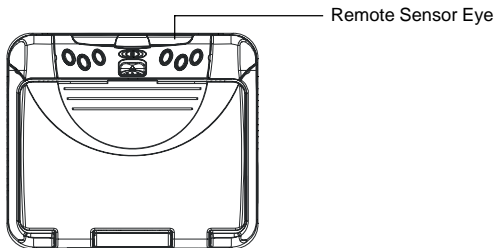

ACCESSORIES

WIRELESS HEADPHONES (Optional)

The MMD85A includes a built in infrared transmitter for use with Movies 2 Go wireless headphones (PN MMIRHS). Turning the Wireless Headphone switch ON will activate the internal IR receiver and the volume can then be adjusted separately with the controls on each headset. Any number of wireless headphones can be used, but all must be within direct line of sight from the transmitter. See the documentation accompanying your Movies 2 Go wireless headphones for more detailed information.

Wired Headphones (Optional)

There are two 1/8" headphone jacks on the MMD85A that can be used with any standard wired stereo headphones. These jacks are controlled by the volume up/down buttons on the MMD85A remote control.

Wireless FM Modulator

The MMD85A is equipped with built-in wireless FM Modulator*, that allows you to listen to the MMD85A audio signal by tuning your vehicle's radio to the selected frequency, (88.3, 88.7, 89.1, 89.5, 89.9MHz). This feature is accessed by using the FM transmitter buttons on the remote (ON/OFF, Channel Select). Whenever the FM modulator is on, broadcast reception on the vehicles radio may be poor. Switching off the FM modulator will allow normal radio reception.

***NOTE:** In certain areas where there are a large number of FM radio stations (e.g. large cities, urban areas), the reception of the FM signal from the overhead pod may not be satisfactory, resulting in static, distorted sound or signal bleed thru from strong local radio stations. This is not a defect in the product, but the result of a stronger local radio station overpowering the wireless FM transmitter in your overhead pod.

If wireless reception is unsatisfactory, an optional wired relay box (Audiovox P/N SIRSWB) can be installed which will improve audio quality. Please contact the installer if this is the case with your product.

MMD85A

21

SOURCE FEATURE

AV1

The video input may be connected to a Video Cassette Player (VCP), video game system, or other audio/video devices. To access the A/V inputs, turn the MMD85A on, press the source button on the MMD85A or the Source button on the remote control until "AV1" is displayed on the screen. Turn the video source component on with its power button or remote control. The MMD85A is now ready to play the audio and video signals from the source connected to AV1 input.

AUX A/V Input

Using the supplied A/V Adapter Cable (P/N 112B3227) the MMD85A will accept an audio/video input through the 1/8" jack located on the right side of the unit. The audio/video device could be a video game system, video camera, or other input device.

DVD Basics

To get the optimum use out of the DVD section, make sure you read this section completely.

Regional Coding

Both the DVD player and disc are coded by region. These regional codes must match in order for the disc to play. If the codes don't match, the disc won't play. This unit's code is region 1. Other regional codes cannot be played in this unit. The unit will display "WRONG REGION".

Types of Discs your DVD will play

- DVD disc - DVD discs which contain video.
- Audio discs - Audio CDs contain musical or sound content only.
- MP3 discs - A disc that contains audio files (for example, a CD-R with downloaded MP3 files).
- VCD discs - VCD discs which contain video.

Loading and Playing Discs

Before you load a disc, make sure that it is compatible with the player.

Note : the following Discs CANNOT be used with this player :

- **MiniDisc**
- **Laserdisc**
- **CD-1, CD-ROM, DVD-ROM, Super Audio CD (SACD), DVD Audio**

To load and Play a Disc

Press the Power button to turn the unit ON. Select DVD mode and insert the disc (Label Up) into the disc compartment.

Troubleshooting

PROBLEM	SOLUTION
IR sensor inoperative	<ul style="list-style-type: none">• Verify that the batteries in the remote are fresh.• Verify that the remote sensor eye is not obstructed.
Disc won't play	<ul style="list-style-type: none">• Insert a disc with the label side facing up.• Check the type of disc you put into disc tray. This DVD only plays DVDs, audio CDs and MP3s.• Both the unit and the disc are coded by region. If the regional codes don't match, the disc can't be played. This DVD player is set to Region Number 1.
Play starts, but then stops immediately	<ul style="list-style-type: none">• The disc is dirty. Clean it.• Condensation has formed. Allow player to dry out.
No sound or distorted sound	<ul style="list-style-type: none">• Make sure your DVD is connected properly. Make sure all cables are securely inserted into the appropriate jacks.• If you are using the IR headphones, make sure you turn on the IR headphone power.• Make sure the Modulator is ON and the proper Frequency has been selected.

PROBLEM	SOLUTION
Can't advance through a movie	<ul style="list-style-type: none"> You can't advance through the opening credits and warning information that appears at the beginning of movies because the disc is programmed to prohibit that action.
The icon (⊗) appears on (Ⓜ) screen	<p>The feature or action cannot be completed at this time because:</p> <ol style="list-style-type: none"> The disc's software restricts it. The disc's software doesn't support the feature (e.g., angles) The feature is not available at the moment. You've requested a title or chapter number that is out of range.
Picture is distorted	<ul style="list-style-type: none"> The disc might be damaged. Try another disc. It is normal for some distortion to appear during forward or reverse scan.
No forward or reverse scan	<ul style="list-style-type: none"> Some discs have sections that prohibit rapid scanning or title and chapter skip. If you try to skip through the warning information and credits at the beginning of a movie, you won't be able to. This part of the movie is often programmed to prohibit skipping through it.

Replacement Parts

Remote Control	1364057
A/V Adapter Cable	112B3227

Specifications

LCD Backlighting	Edge Light Tube
Resolution	1440 x 234
Pixels	336,960
Operation Temperature	32-140°F (0-60°C)
Storage Temperature	-4-176°F (-20-80°C)
Backlight life	10,000 Hours
Video Display System	NTSC/PAL
Headphone Audio Output	0.03W@32 ohms
Video Output	1.0Vp-p @ 75 ohms
Power Source	12V DC
Dimensions	H x W x D Inches 1.8 x 10.2 x 8.8 (45.7 x 260 x 223.5mm)



12 MONTH LIMITED WARRANTY

Applies to Movies To Go Mobile Video Products

AUDIOVOX ELECTRONICS CORP. (the Company) warrants to the original retail purchaser of this product that should this product or any part thereof, under normal use and conditions, be proven defective in material or workmanship within 12 months from the date of original purchase, such defect(s) will be repaired or replaced with reconditioned product (at the Company's option) without charge for parts and repair labor. A game controller, if supplied, is similarly warranted for ninety (90) days.

To obtain repair or replacement within the terms of this Warranty, the product is to be delivered with proof of warranty coverage (e.g. dated bill of sale), specification of defect(s), transportation prepaid, to the Company at the address shown below.

This Warranty does not extend to the elimination of externally generated static or noise, to correction of antenna problems, to costs incurred for installation, removal or reinstallation of the product, or to damage to digital memory cards, discs, speakers, accessories, or vehicle electrical systems.

This Warranty does not apply to any product or part thereof which, in the opinion of the Company, has suffered or been damaged through alteration, improper installation, mishandling, misuse, neglect, accident, or by removal or defacement of the factory serial number/bar code label(s). THE EXTENT OF THE COMPANY'S LIABILITY UNDER THIS WARRANTY IS LIMITED TO THE REPAIR OR REPLACEMENT PROVIDED ABOVE AND, IN NO EVENT, SHALL THE COMPANY'S LIABILITY EXCEED THE PURCHASE PRICE PAID BY PURCHASER FOR THE PRODUCT.

This Warranty is in lieu of all other express warranties or liabilities. ANY IMPLIED WARRANTIES, INCLUDING ANY IMPLIED WARRANTY OF MERCHANTABILITY, SHALL BE LIMITED TO THE DURATION OF THIS WRITTEN WARRANTY. ANY ACTION FOR BREACH OF ANY WARRANTY HEREUNDER INCLUDING ANY IMPLIED WARRANTY OF MERCHANTABILITY MUST BE BROUGHT WITHIN A PERIOD OF 24 MONTHS FROM DATE OF ORIGINAL PURCHASE. IN NO CASE SHALL THE COMPANY BE LIABLE FOR ANY CONSEQUENTIAL OR INCIDENTAL DAMAGES FOR BREACH OF THIS OR ANY OTHER WARRANTY, EXPRESS OR IMPLIED, WHATSOEVER. No person or representative is authorized to assume for the Company any liability other than expressed herein in connection with the sale of this product.

Some states do not allow limitations on how long an implied warranty lasts or the exclusion or limitation of incidental or consequential damage so the above limitations or exclusions may not apply to you. This Warranty gives you specific legal rights and you may also have other rights which vary from state to state.

U.S.A. : AUDIOVOX ELECTRONICS CORPORATION 150 MARCUS BLVD., HAUPPAUGE, NEW YORK 11788 • 1-800-645-4994

CANADA : CALL 1-800-645-4994 FOR LOCATION OF WARRANTY STATION SERVING YOUR AREA

© 2005 Audiovox Electronics Corporation

128-6429E