

EN

No film output on this page

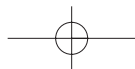
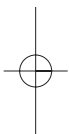

RCA

U
S
E
R
M
A
N
U
A
L

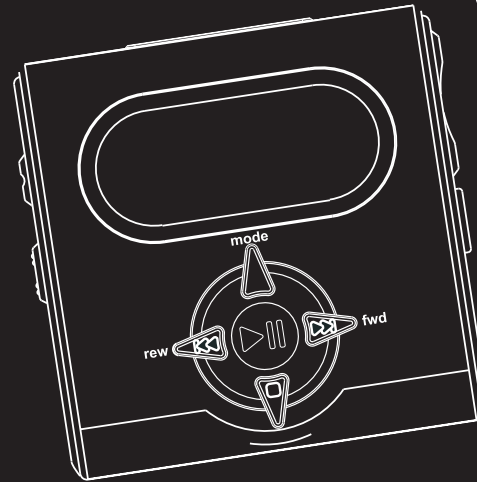

IMPORTADOR
Comercializadora Thomson de México, S.A. de C.V.
Miguel de Cervantes Saavedra 57
Col. Ampliación Granada
C.P. 11529 Mexico D.F.
Teléfono: (55)25 81 53 20
RFC: CTM-980723-KS5

EXPORTER
Thomson multimedia Inc.
P.O. Box 1976
Indianapolis, IN 46206-1976
© 2002 Thomson multimedia Inc.
Trademark(s) ® Registered
Marca(s) ® Registrada(s)
Marque(s) ® Déposé(e)
55437280 (EN/E/F)
www.rca.com
www.rca.com/LatinAmerica
Printed In China / Impreso en China

RD1020 / RD1070

It is important to read this instruction book prior to using your new product for the first time.
Es importante leer este manual antes de usar por vez primera su equipo.

FCC Information

FCC Information

This equipment has been tested and found to comply with limits for a Class B digital device, pursuant to Part 15 of the FCC Rules. These limits are designed to provide reasonable protection against harmful interference in a residential installation. This equipment generates, uses and can radiate radio frequency energy and, if not installed and used in accordance with the instruction, may cause harmful interference to radio communications. However, there is no guarantee that interference will not occur in a particular installation. If this equipment does cause harmful interference to radio or television reception, which can be determined by turning the equipment off and on, the user is encouraged to try to correct the interference by one or more of the following measures:

- Reorient or relocate the receiving antenna.
- Increase the separation between the equipment and receiver.
- Connect the equipment into an outlet on a circuit different from that to which the receiver is connected.
- Consult the dealer or an experienced radio/TV technician for help.

Note: Modifications not authorized by the manufacturer may void users authority to operate this device.

RCA RD1020
 Tested to Comply
 With FCC Standards
 FOR HOME OR OFFICE USE

RCA RD1070
 Tested to Comply
 With FCC Standards
 FOR HOME OR OFFICE USE

For Your Records

In the event that service should be required, you may need both the model number and the serial number. In the space below, record the date and place of purchase, and the serial number:
 Date of Purchase
 Place of Purchase
 Serial No.

Service Information

This product should be serviced only by those specially trained in appropriate servicing techniques. For instructions on how to obtain service, refer to the warranty included in this Guide.

This Class B digital apparatus complies with Canadian ICES-003.
 Cet appareil numérique de la class B est conforme à la norme du NMB-003 du Canada

Important Information

Warning

- Do not play your headset at a high volume. Hearing experts warn against extended high-volume play.
- If you experience a ringing in your ears, reduce volume or discontinue use.
- You should use extreme caution or temporarily discontinue use in potentially hazardous situations.

Even if your headset is an open-air type designed to let you hear outside sounds, don't turn up the volume so high that you are unable to hear what is around you.

Caution While Driving: Use of headphones while operating an automobile or moving vehicle is not recommended and is unlawful in some states and areas. Be careful and attentive on the road. Stop operation of the unit if you find it disruptive or distracting while driving.

Precautions for the Unit

- Do not use the unit immediately after transportation from a cold place to a warm place; condensation problem may result.
- Avoid shock to the unit especially during recording. Recorded data may be damaged.
- Do not store the unit near fire, places with high temperature or in direct sunlight.
- Do not operate or store unit in places with frequent static electricity or electrical noise (e.g. speaker, TV set).
- Clean the unit with a soft cloth or a damp chamois leather. Never use solvents.
- The unit must only be opened by qualified personnel.

Warning: Use of this product is for your personal use only. Copying CDs or downloading music files for sale or other business purposes is a violation of copyright law. It is also a violation of copyright law to download files without permission of the copyright owner.

EN

Important Information

Care of Memory Card (Not Included)

- Do not touch the golden electrodes. Use a soft dry cloth to clean any dirt.
- Do not bend Memory Cards.
- Do not operate or store MultiMediaCards in places with frequent static electricity or electrical noise (e.g. speaker, TV set). Recorded data may be damaged.
- It is normal for Memory Card to get warm after being used for a long time.
- Always put it in storage case after removing from the unit.
- Do not store Memory Card near fire, places with high temperature/ humidity or in direct sunlight.

Power supply

- Battery power: AAA (LR03) x 2.

Battery Precautions

- When storing the unit, be sure to remove the batteries because they may leak and damage the unit.
- Batteries may leak electrolyte if inserted incorrectly, if disposed of in fire, or if an attempt is made to charge a battery not intended to be recharged.
- Never mix new batteries with old ones. Do not mix battery types.
- Discard leaky batteries immediately. Leaking batteries may cause skin burns or other personal injury.
- Do not charge batteries which are not intended to be recharged.
- Dispose of batteries, according to federal, state and local regulations.

The descriptions and characteristics given in this document are given as a general indication and not as a guarantee. In order to provide the highest quality product possible, we reserve the right to make any improvement or modification without prior notice. The English version serves as the final reference on all product and operational details should any discrepancies arise in other languages.

Table of Content

FCC Information

Important Information

Before You Begin1

1. Unpacking the player and accessories1
2. What's so special about this MP3 player1
3. Insert batteries into the player . . .2
4. Inserting a Memory Card (optional)2
5. Using Headphones3
6. Connecting the Player to your Computer3

General Controls4

Display5

General Operation6

- Playback / Pause6
- Stop Playback6
- Key Lock6

Skip / Search (Scan)6

Adjust volume Level6

Advanced Operation7

- DSP7
- Play Modes7
- Programming Tracks7
- Editing Program8
- File Download8

Troubleshooting Tips9

Limited Warranty

EN

Before you Begin

1. Unpack the player and accessories

When you unpack your new player, be sure you have removed all the accessories and information papers. The items shown below are packed with your player.

1. The Player
2. Batteries
3. Software CD
4. Headphones
5. Connection Cable
6. Carry Case

2. What's so special about this MP3 player?

This player is meant to play MP3 audio files encoded on a memory card or recorded in the built-in flash memory.

To do so, you need the use of a Windows computer with USB port, connection cable (included) and a music management software (MusicMatch Jukebox).

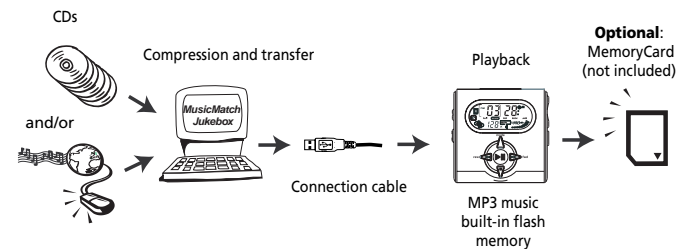

Compressed music internet sites
www.musicmatch.com, www.emusic.com

1

Before You Begin

3. Insert batteries into the player

A. To insert batteries, open the battery compartment door.

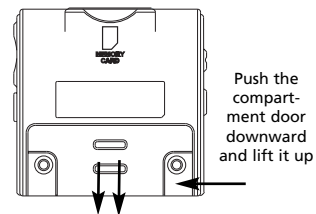

B. Insert 2 "AAA"(LR03) batteries with polarities corresponding to indications on the compartment.

C. Close the door to the battery compartment

Note: Refer to the power level indicator on display for battery level. Replace with new batteries when the indicator is empty.

4. Inserting a MultiMedia Card / SD Card (Optional)

The player has built-in flash memory (64MB for RD1020 / 128MB for RD1070). To extend the playtime, you can use the optional Memory Card slot.

A. Insert a Memory Card into the card slot when the player is off as the diagram shows:

B. To remove card, push the Memory Card to eject.

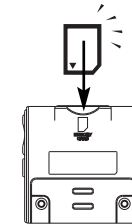

Caution: Do not remove Memory Card during playback or when power is on. It may stop unit from playing immediately.

2

EN

Before You Begin

5. Using Headphones

Insert phone jack into **PHONES** on the side of player for listening.

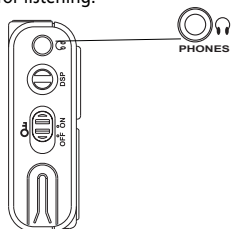

Note: Have a Blast- Just Not in Your Eardrums. Make sure you turn down the volume on the unit before you put on headphones. Increase the volume to the desired level only after headphones are in place.



6. Connecting the Player to your Computer

1. Lift the rubber cover on the player.
2. Insert the smaller end of the connection cable into the socket tightly.
3. Insert the opposite end of the connecting cable to the USB socket on the back of the computer.

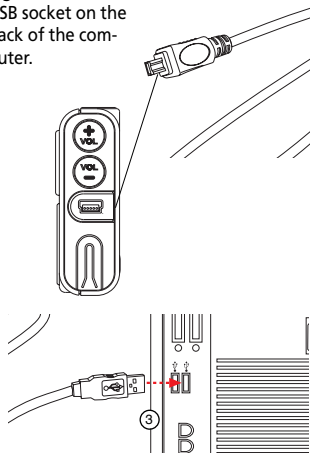

Note: Refer to the Software Instruction manual for procedures in setting up USB drivers and transferring files to the player.

3

General Controls

EN

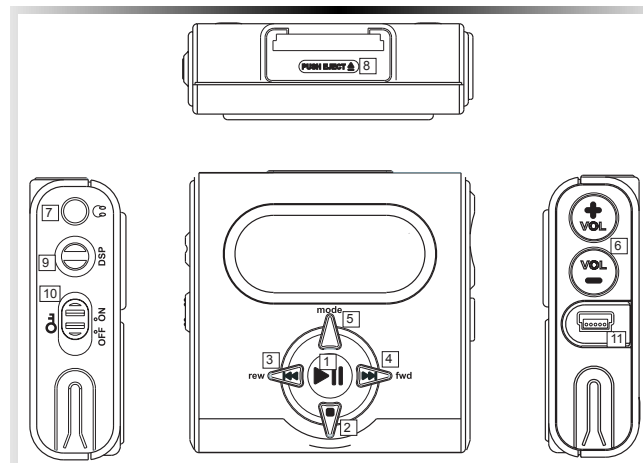

1. **PLAY** - Turn unit on, start playback and pause.
2. **STOP** - Stop playback and turn unit off.
3. **Skip backward** - Skip back to last track. Press and hold to search backward within the same track.
4. **Skip forward** - Skip to next track. Press and hold to search forward within saved tracks.
5. **MODE** - Select among repeat all, random, random repeat, program and repeat program modes. (For more on programming mode, please refer to page 7)
6. **VOLUME** - Adjust sound volume.
7. **PHONES** - headphones jack.
8. **MEMORY CARD** - Slot for inserting external memory card. (MMC / SD)
9. **DSP** - Select among DSP modes. (Flat, Bass, Pop, Rock, Jazz)
10. **LOCK** - To lock keys to avoid accidental key activation.
11. **USB** - Connects USB cable.

4

Display

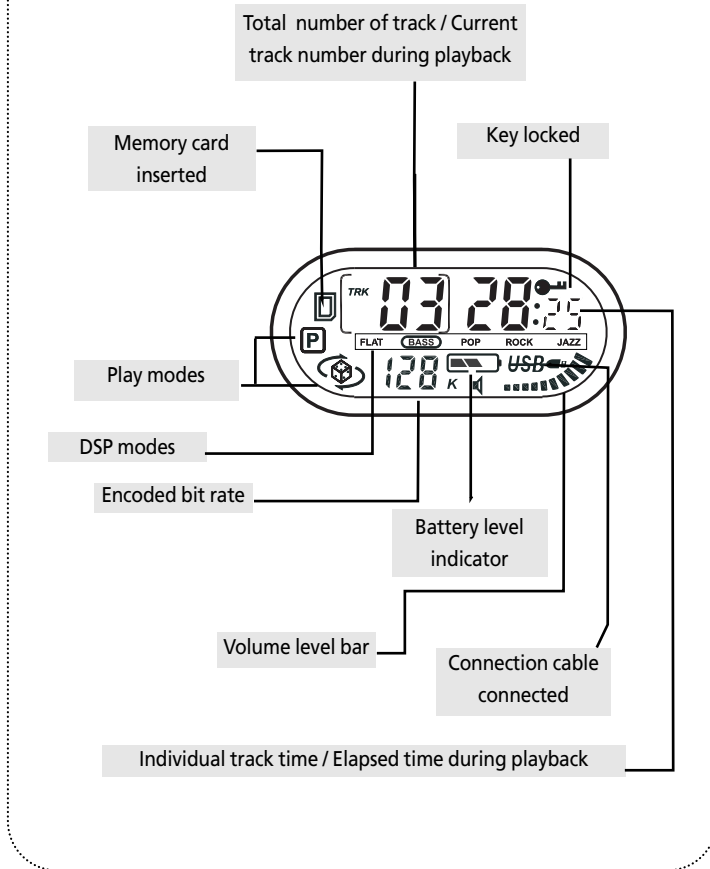

5

General Operation

Playback / Pause

- Press **PLAY** to turn the unit on. Playback then starts automatically from the first track.
- In stop mode, press **PLAY** to start playback of selected track. Current track number, elapsed playback time and encoded bit rate show on display.
- Press **PLAY** during playback to pause playing and press **PLAY** again to resume playback.

Stop Playback

- During playback, press **STOP** to stop playback with total number of tracks shown on display.
- Press **STOP** again to turn unit off. (The unit will also turn itself off automatically after about 1 minute if there is no key activation.)

Skip / Search (Scan)

- In stop mode, press **Skip backward** or **Skip forward** to select desired tracks.
- During playback, press **Skip forward** once to skip to next track starting. Press and hold for quick forward scan of playing track.
- Press **Skip backward** once to return to previous track start. Press and hold for quick backward scan of playing track.

Note: If the elapsed time of the playing track is less than 0:04, pressing **Skip backward** once will return to previous track.

If the elapsed time of the playing track is greater than 0:04, pressing **Skip backward** once will return to the beginning of the current track.

Adjust Volume Level

- Press **VOL +** or **VOL -** to adjust sound volume. Refer to the volume bar on display for sound level.

Key Lock

To avoid accidental key activation, slide the **LOCK** key to **ON** position to lock keys. Lock icon  can be seen on display. Slide to **OFF** position to unlock keys.

EN

6

General Operation

DSP

• Press repeatedly to select among the DSP modes:



FLAT > BASS > POP > ROCK > JAZZ



Play modes

• Press **MODE** repeatedly during playback to switch among the following playback modes:

Normal playback > Repeat All > Random > Random repeat > Program > Repeat program > Normal playback

Note: Program  and Repeat program  will only appear if there are programmed tracks.

Programming Tracks

1. Press and hold **MODE** for 2 seconds in stop mode to enter program mode. You will see 'P' icon lit representing program mode, flashing ' - ' for track selection and 'P01' for program list position.

2. Press **Skip backward** or **Skip forward** to select a track. Selected track number will flash.

Note: The player will enter Intro Play mode and play the beginning of each track as you scroll through tracks for programming .

3. Press **MODE** to confirm selection.

4. Press **MODE** again to skip to the next programming position.

5. Repeat steps 2-4 for further selections. Maximum 20 selections can be made.

6. Press **STOP** to exit programming mode or unit returns to stop mode automatically after 30 seconds if there is no key activation.

See section on "Play Modes" to playback programmed tracks.

Advanced Operation

Editing program

Overwriting Programmed Tracks

1. In stop mode, press and hold **MODE** to enter program mode.

2. Press **MODE** to select the programmed track you want to overwrite.

3. Press **Skip backward** or **Skip forward** to select the new track you want to store.

4. Press **MODE** to confirm selection.

5. Repeat steps 2 and 3 to overwrite additional programmed tracks.

Deleting Programmed Tracks

1. In stop mode, press and hold **MODE** to enter program mode.

2. Press **MODE** to select the programmed track to be deleted.

3. Press and hold **DSP** for about 3 seconds to delete unwanted track from your program list, ' - - ' will show on display to indicate successful deletion.

4. Repeat steps 2 and 3 to delete additional tracks from the program list.

5. To cancel editing program, press **STOP** once, or unit will return to stop mode automatically after 30 seconds if there is no key activation.

File Download

When the unit is connected to the computer,  will be displayed on the screen.

During transfer, the icon will flash. When the transfer is complete, the icon will remain lit. Do not unplug the USB cable when the icon is flashing.

NOTE:

See *Software Instruction Manual for instructions to install USB driver, music management software and to transfer tracks to player and/or memory card.*

EN

Troubleshooting Tips

The player does not turn on when **PLAY** button pressed.

- Batteries may be inserted incorrectly.
- Batteries may be empty.

Skipping tracks or bad sound quality?

- Repeat, random or program function may be activated.
- There may be strong magnetic fields (e.g. too close to TV) near the unit.
- Low Battery level. Replace with new ones.

Cannot perform playback?

- **LOCK** function may be activated.
- There may be no MP3 tracks in the card or internal memory.
- Memory Card may be damaged.

Cannot play tracks on the player?

- Track encoded bit rate may not be between 32 to 192 kbps for MP3 or between 64kbps to 128kbps for Windows Media Audio.

Note: For better result, we recommend a constant encoded bit rate from 32 to 320kbps for MP3 and 48kbps to 128kbps for Windows Media audio. Nevertheless, your unit may play tracks encoded in variable bit rate (VBR).

USB display does not appear when connected to computer.

- Check connection between your unit and the computer. (Refer to Software Instruction Manual)
- Check if USB drivers are properly installed (Refer to Software Instruction Manual)

The player does not respond to key operations?

- Turn the player off by removing the batteries. Reinsert the batteries properly and turn the player on again to resume normal operations.

Why is the **CARD** icon keep flashing on display?

- Check if the memory card inserted is in correct format.

US Limited Warranty

What your warranty covers:

- Defects in materials or workmanship.

For how long after your purchase:

- One year from date of purchase.
- The warranty period for rental units begins with the first rental or 45 days from date of shipment to the rental firm, whichever comes first.

What we will do:

- Provide you with a new, or at our option, a refurbished unit. The exchange unit is under warranty for the remainder of the original product's warranty period.
- Proof of purchase in the form of a bill of sale or receipted invoice which is evidence that the product is within the warranty period must be presented to obtain warranty service. For rental firms, proof of first rental is also required.

How to make a warranty claim:

- Properly pack your unit. Include any cables, etc., which were originally provided with the product. We recommend using the original carton and packing materials.
- Include evidence of purchase date such as the bill of sale. Also print your name and address and a description of the defect. Send via standard UPS or its equivalent to:

Thomson multimedia Inc.
Product Exchange Center
11721 B Alameda Avenue
Socorro, Texas 79927

- Insure your shipment for of loss or damage. Thomson accepts no liability in case of damage or loss en route to Thomson.
- Pay any charges billed to you by the Exchange Center for service not covered by the warranty.
- A new or refurbished unit will be shipped to you freight prepaid.

What your warranty does not cover:

- Customer instruction. (Your Owner's Manual provides information regarding operating Instructions and user controls. For additional information, ask your dealer.)
- Installation and set-up service adjustments.
- Batteries.
- Damage from misuse or neglect.
- Products which have been modified or incorporated into other products.
- Products purchased or serviced outside the USA.
- Acts of nature, such as but not limited to lightning damage.

US Limited Warranty

Product Registration:

- Please complete and mail the Product registration Card packed with your unit. It will make it easier to contact you should it ever be necessary. The return of the card is not required for warranty coverage.

Limitation of Warranty:

- **THE WARRANTY STATED ABOVE IS THE ONLY WARRANTY APPLICABLE TO THIS PRODUCT. ALL OTHER WARRANTIES, EXPRESS OR IMPLIED (INCLUDING ALL IMPLIED WARRANTIES OF MERCHANTABILITY OR FITNESS FOR A PARTICULAR PURPOSE) ARE HEREBY DISCLAIMED. NO VERBAL OR WRITTEN INFORMATION GIVEN BY THOMSON MULTIMEDIA INC., ITS AGENTS OR EMPLOYEES SHALL CREATE A WARRANTY OR IN ANY WAY INCREASE THE SCOPE OF THIS WARRANTY.**
- **REPAIR OR REPLACEMENT AS PROVIDED UNDER THIS WARRANTY IS THE EXCLUSIVE REMEDY OF THE CONSUMER. THOMSON MULTIMEDIA INC. SHALL NOT BE LIABLE FOR INCIDENTAL OR CONSEQUENTIAL DAMAGES RESULTING FROM THE USE OF THIS PRODUCT OR ARISING OUT OF ANY BREACH OF ANY EXPRESS OR IMPLIED WARRANTY ON THIS PRODUCT. THIS DISCLAIMER OF WARRANTIES AND LIMITED WARRANTY ARE GOVERNED BY THE LAWS OF THE STATE OF INDIANA. EXCEPT TO THE EXTENT PROHIBITED BY APPLICABLE LAW, ANY IMPLIED WARRANTY OF MERCHANTABILITY OR FITNESS FOR A PARTICULAR PURPOSE ON THIS PRODUCT IS LIMITED TO THE APPLICABLE WARRANTY PERIOD SET FORTH ABOVE.**

How state law relates to this warranty:

- Some states do not allow the exclusion nor limitation of incidental or consequential damages, or limitations on how long an implied warranty lasts, so the above limitations or exclusions may not apply to you.
- This warranty gives you specific legal rights, and you also may have other rights that vary from state to state.

If you purchased your product outside the USA:

- This warranty does not apply. Contact your dealer for warranty information.

Canadian Limited Warranty

EN

Thomson multimedia Ltd. warrants to the purchaser or gift recipient that if any manufacturing defect becomes apparent in this product within 1 year from the original date of purchase, it will be replaced free of charge, including return transportation.

This warranty does not include damage to the product resulting from accidents, misuse or leaking batteries.

Should your product not perform properly during the warranty period, either:

1. Return it to the selling dealer with proof of purchase for replacement,
OR
2. Remove the batteries (where applicable), and pack product complete with accessories in the original carton (or equivalent).

— Mail prepaid (with proof of purchase) and insured to:

**Thomson multimedia Ltd.
6200 Edwards Blvd.,
Mississauga, Ontario,
L5T 2V7
Canada**

The provisions of this written warranty are in addition to and not a modification of or subtraction from the statutory warranties and other rights and remedies contained in any applicable legislation, and to the extent that any such provisions purport to disclaim, exclude or limit any such statutory warranties and other rights and remedies, such provisions shall be deemed to be amended to the extent necessary to comply therewith.

If you are unable to find a qualified servicer for out of warranty service, you may write to: Thomson multimedia Ltd.

P.O. Box 0944
Indianapolis, Indiana, U.S.A., 46206-0944

Attach your sales receipt to this booklet for future reference. This information is required if service is needed during the warranty period.

PURCHASE DATE

NAME OF STORE