

**10.1" SmartTV Ready Overhead
In-Vehicle Entertainment System
With Built-In DVD Player / HDMI
for SmartTV connectivity
(Optional) / USB and A/V Inputs**

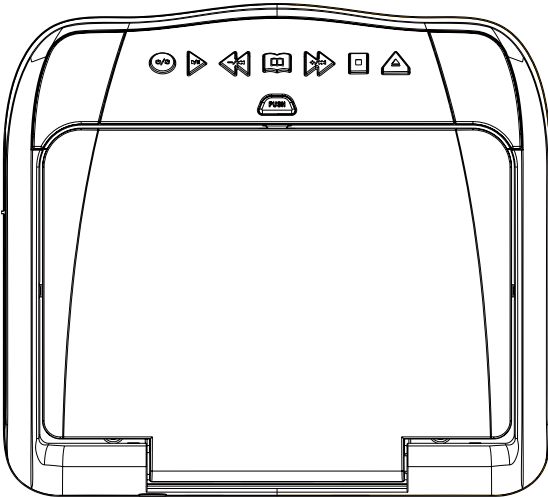

**OWNER'S
MANUAL**

HDMI
HIGH-DEFINITION MULTIMEDIA INTERFACE

DVD
VIDEO

TABLE OF CONTENTS

FCC Statement.....	3
Important Notice.....	4
Warnings.....	4
Congratulations	5
Safety Precaution	5
Features	5
Controls and indicators diagram(front view)	6
Controls and indicators diagram(side view).....	7
Remote Control Operation	8
Remote Control Functions	9
Turning the unit on or off.....	13
Source menu	14
System Menu Setting and Adjustments	16
Playing DVDs and Audio Discs.....	24
Playing USB Devices.....	24
Playing MP3 Discs	25
DVD Basics	26
HDMI Devices.....	27
USB Input.....	28
Troubleshooting	29
Specifications.....	30
Warranty	31

FCC Statement

This device complies with Part 15 of the FCC Rules. Operation is subject to the following two conditions: (1) This device may not cause harmful interference, and (2) this device must accept any interference received, including interference that may cause undesired operation. This equipment has been tested and found to comply with the limits for a Class B digital device, pursuant to Part 15 of the FCC Rules. These limits are designed to provide reasonable protection against harmful interference in a residential installation.

-Reorient or relocate the receiving antenna.

- Increase the separation between the equipment and receiver.

- Connect the equipment into an outlet on a circuit different from that to which the receiver is connected.

- Consult the dealer or an experienced radio/TV technician for help.

FCC Caution: Any change or modifications not expressly approved by the party responsible for compliance could void the user's authority to operate this equipment.

Radiation Exposure Statement

This equipment complies with FCC radiation limits set forth for an uncontrolled environment. This equipment should be installed and operated with minimum distance 4.5in (20cm) between the radiator & your body.

Important Notice

Installation of overhead products requires careful planning and preparation. Be extremely careful when working on a vehicle with side curtain air bags. Do not route wires near any portion of the side curtain air bag assemblies. This includes any anchor points in A, B, C or D pillars of the vehicle. Routing wires in these areas or running wires by the side curtain air bags can prevent the side curtain air bag from fully deploying which can result in personal injury to vehicle occupants. If you have any questions regarding wire routing in a vehicle, please contact Voxx Technical Support at 1-800-225-6074.

When connecting power and ground in a mobile video installation ensure that the ACC wire is fused at the point where it is connected to the vehicle ACC wiring. Failure to do so can result in damage to the vehicle if a short circuit develops between the vehicle connection point and the mobile video product.

An LCD panel and/or video monitor may be installed in a motor vehicle and visible to the driver if the LCD panel or video monitor is used for vehicle information, system control, rear or side observation or navigation. If the LCD panel or video monitor is used for television reception, video or DVD play, the LCD panel or video monitor must be installed so that these features will only function when the vehicle is in "park" or when the vehicle's parking brake is applied.

An LCD panel or video monitor used for television reception, video or DVD play that operates when the vehicle is in gear or when the parking brake is not applied must be installed to the rear of the driver's seat where it will not be visible, directly or indirectly, to the operator of the motor vehicle.

Warnings

- Do not use any solvents or cleaning materials when cleaning the video monitor.
- Do not use any abrasive cleaners, they may scratch the screen.
- Use only a lightly dampened lint free cloth to wipe the screen if it is dirty.
- Lock the LCD screen in the fully closed position when not in use.
- Before putting on headphones always adjust the volume setting to the lowest position.
- Remember to leave the dome light switch in the off or auto positions when the vehicle is unattended, as the dome lights, if left on, can drain the vehicle's battery.
- Do not put pressure on the screen.
- Caution children to avoid touching or scratching the screen, as it may become dirty or damaged.

Patented: Refer to www.voxxintl.com/company/patents

Congratulations

Congratulations on your purchase of this In-Vehicle Entertainment System . This system has been designed to give you and your family many years of video entertainment in the mobile environment. Please read the directions that follow to familiarize yourself with the product to ensure that you obtain the best results from your equipment.

Note: Installation options vary, see the individual owner's manuals for each component in your system to obtain a full understanding of each component's operation.

Safety Precaution

For safety reasons, when changing video media, it is recommended that the vehicle is not in motion, and that you do not allow children to unfasten seat belts to change video media or make any adjustments to the system. System adjustments can be accomplished using the remote control, while seat belts remain fastened. Enjoy your In- Vehicle entertainment system but remember the safety of all passengers remains the number one priority.

FEATURES

- 10.1" TFT (Thin Film Transistor) Active Matrix LCD (Liquid Crystal Display) Monitor
- LED Backlighting
- Built-in DVD Player
- Auto-On With Disc Insertion
- OSD (On Screen Display) for Control of Picture Quality and Functions
- Dual IR Receiver (Front and Rear)
- Switchable Dual Channel IR Infrared Transmitter
- Five Source Input (DVD, USB, HDMI 1, HDMI 2, AV)
- Dome Lights with Built-in Three Way Switch
- Last Position Memory for DVD
- Screen Mode Selection (4:3, 16:9)
- Full Function Remote Control
- Backlit Controls
- AV Output via RCA Jacks
- Plays DVD, CD and MP3 Discs

CONTROLS AND INDICATORS DIAGRAM (FRONT VIEW)

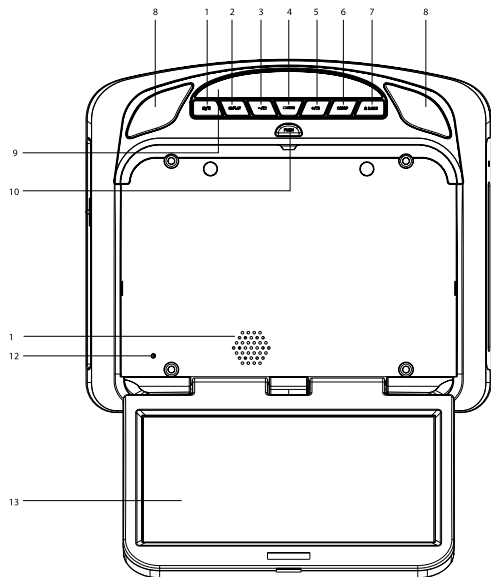

1. POWER and SOURCE/SELECT (⏻/🔄) Button

This button is used to turn the system on/off. Short press to turn on the system, long press to turn off the system. When system already turn on, this button will become source select function.

2. Play/Pause (▶/⏸) Button

This button is used to start playback of a disc or pause a disc.

3. DOWN / Previous (◀/⏮) Button

Short press to select the source mode and system menu pages.
Long press to select previous chapter or track during play the DVD.

4. HOME/MENU Select Button

This button is used to display and select options on the system menu.
Press and hold for 3 seconds to access the System Menu.

5. UP/NEXT(+/▶) Button

Short press to select the source mode and system menu pages.
Long press to select next chapter or track during play the DVD.

6. STOP (■) Button

-Press the STOP button once: Stops playback.
-Pressing the PLAY button again will resume normal playback from where movie was stopped.
-Press the STOP button twice and then press the PLAY button to start playback from the beginning of the DVD.

7. EJECT (▲) Button

This button is used for ejecting a disc from the disc compartment.

8. Dome Lights

Provide additional interior illumination.

9. Infrared Transmitter/Remote Sensor

IR Transmitter: is used to broadcast audio signal to wireless IR headphones.
IR Sensor: is used to receive signals from the remote control.

10. Screen Release

Push this button to release the screen from the locked position.

11. Ventilation Openings

12. LCD Off Switch

Used to turn off the LCD backlight when the LCD is in the closed position.

13. LCD Panel

CONTROLS AND INDICATORS DIAGRAM (SIDE VIEWS)

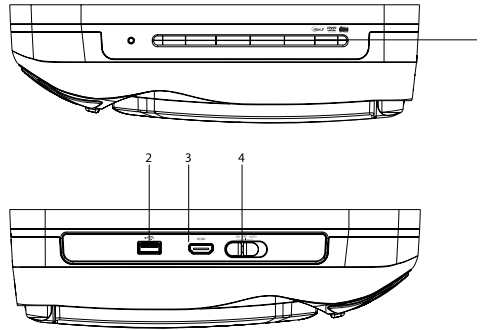

1. DVD DISC INSERTION SLOT

For loading and removing discs. When a disc is inserted, the unit will automatically turn ON and switch to DVD source. Insert a disc with label side facing up.

Note: The disc slot indicator is red when a disc is inserted and green when the disc slot is empty.

2. USB INPUT

For connection of a USB memory device. This input will also charge a USB device that contains a battery.

Note: The USB input supplies up to 1A of charging current. (Samsung Mobile Devices up to 500mA). It is recommended to connect the device to a vehicle power outlet for full charging capabilities.

3. HDMI INPUT

For connection of devices with HDMI outputs. See page 27 for more information.

Note: Requires an HDMI enabled device and may require a special HDMI adapter (ie: Smartphones). Contact your Smartphone device supplier for the appropriate HDMI adapter.

4. THREE POSITION DOME LIGHT SWITCH

ON - Turns on the dome lights.

OFF - The dome lights will not turn on in this position.

AUTO - Automatically turns on the dome lights in conjunction with the vehicle's interior illumination.

REMOTE CONTROL OPERATION

Battery Replacement

1. Remove the battery cover.
2. Insert two AAA batteries into the battery holder. Be sure to observe the correct polarity.
3. Reinstall the battery cover back into the Remote Control until it locks in place.

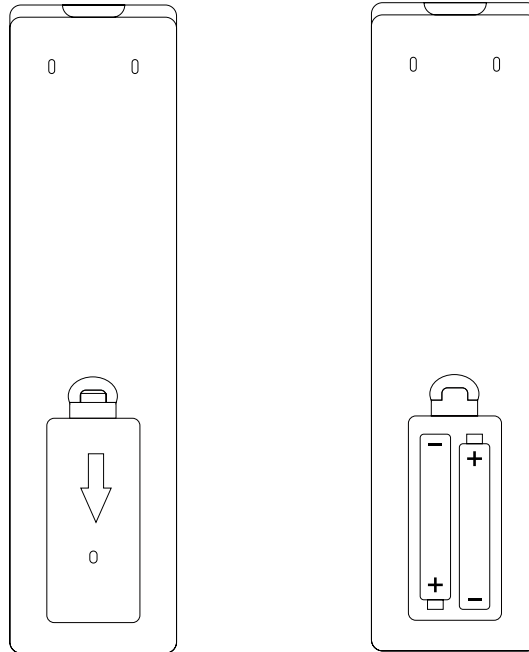

REMOTE CONTROL FUNCTIONS

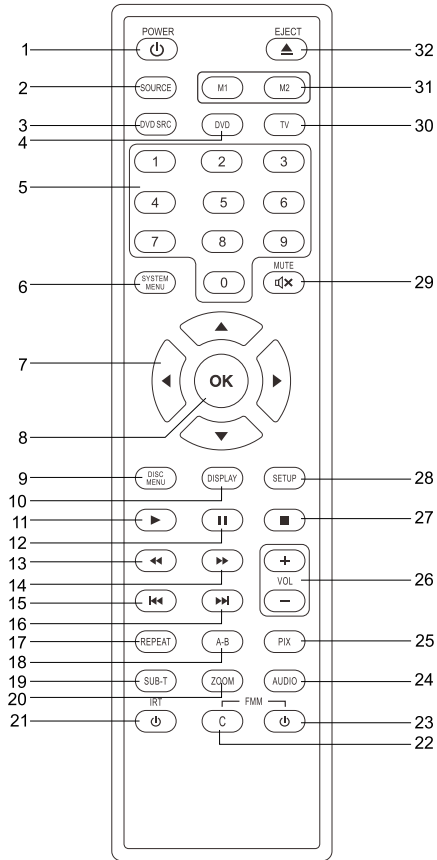

* Function control is available on the unit and the Remote Control.
 ** Function not available in this model.

- 1. POWER***
Press this button to turn the unit ON and OFF.
- 2. SOURCE***
Press to display the Source OSD for DVD, USB, AV, HDMI 1 and HDMI 2.
- 3. DVD Source****
No function on this model.
- 4. DVD Mode Select Button**
Switches certain function keys on the remote control for DVD function.
- 5. NUMBERS**
Allows the user to enter the numbers 0-9 for selection of the tracks, titles, chapters or password setting.
- 6. SYSTEM MENU**
Allows the user to access the system menu. Press the por q cursor buttons to select PICTURE, AUDIO, SYSTEM, PLAYER, FMM and SMART STREAM Settings.
- 7. CURSOR (▲▼◀▶)**
Use the cursor buttons to access menu selections on the screen.
- 8. OK**
Used to execute a selected setting or menu option.
- 9. DISC MENU**
In DVD mode, press once to access the Root Menu and then press again to resume to previous screen.

10. DISPLAY

Press once to display current disc information of Title, Chapter & Time. Press again to display Subtitle, Audio & Angle while the disc is playing.



11. PLAY (▶)*

Press to activate the play mode while a disc is loaded into the disc compartment.

12. PAUSE (⏸)*

Press to pause playback.

13. BACKWARD (◀◀)

Press to search in a backward direction. Press repeatedly to change the search speed from 2, 4, 8, 20 times and normal speed.

14. SCAN FORWARD (▶▶)

Press to search in a forward direction. Press repeatedly to change the search speed from 2, 4, 8, 20 times and normal speed.

15. PREVIOUS (◀◀)

Press to return to the previous chapter or track.

16. NEXT (▶▶)

Press to skip to the next chapter or track.

17. REPEAT

Allows the user to repeat a selected chapter, title or all track.

18. A-B REPEAT

Allows user to repeat the playback from point A to point B.

Press A-B button

On-Screen Display

DVD player

Once

Repeat A

Mark the beginning of the section to repeat (Set point A)

Twice

A-B

Mark the end of the section to repeat (Set point B)

3 times

AB Off

Cancel the A-B repeat function

19. SUBTITLE

Press to display and select the subtitle language in DVD mode. Each time this button is pressed, the subtitle language changes. Pressing the button will also turn the subtitles off.

Note: The type and number of subtitle languages vary from disc to disc.

20. ZOOM

Press this button to enlarge or decrease the picture size when playing a DVD disc.

Press ZOOM button

1 Time
2 Times
3 Times
4 Times
5 Times
6 Times
7 Times

DVD Player performs

Enlarges the picture 2X
Enlarges the picture 3X
Enlarges the picture 4X
Reduces the picture 1/2
Reduces the picture 1/3
Reduces the picture 1/4
Picture is returned to original size

21. IRT ON/OFF

Turns the Infrared Transmitter on/off for IR wireless headphones.

22. FM MODULATOR CHANNEL SELECT (C)**

No function on this model.

User may use the system menu to select the FM Modulator.

23. FMM ON/OFF

Turns the FM Modulator power on/off.

24. AUDIO

Press to display and select audio language in DVD mode. Each time this button is pressed, the language changes.

25. PIX (Picture Select)**

This button is used to make picture adjustments. Use the UP or DOWN direction buttons to select BRIGHTNESS, CONTRAST, COLOR, TINT, or RESET. Use the UP or DOWN buttons to adjust the setting. The OSD will automatically disappear if no adjustments are made within 6 seconds.

26. VOLUME DOWN (-) or UP (+)**

No function on this model.

27. STOP (■)*

Press to stop playback. (Playback will resume from the point it is stopped).

Press twice to stop playback fully. (Playback will resume from the beginning of the disc).

Note: For MP3 or photo mode, press twice to return to Audio/Photo/Video option menu.

28. SETUP**

No function on this model.

User can use the system to select the function may need.

29. MUTE

Press this button to mute the audio for the wireless FM Modulator, IR headphones and audio output.

Pressing the button again restores the audio to the previously set level.

30. TV Mode Select

Switches certain function keys on the remote control for monitor functions.

31. MONITOR SELECT

M1 Button – Set the remote control code to allow control of the unit in M1 mode.

M2 Button – Set the remote control code to allow control of the unit in M2 mode.

Note: M1/M2 operation is only for when 2 systems are installed in the same vehicle. This allows independent Remote Control and independent playback of audio for each system.

32. EJECT (▲)*



Press this button to eject the disc.

TURNING THE UNIT ON OR OFF

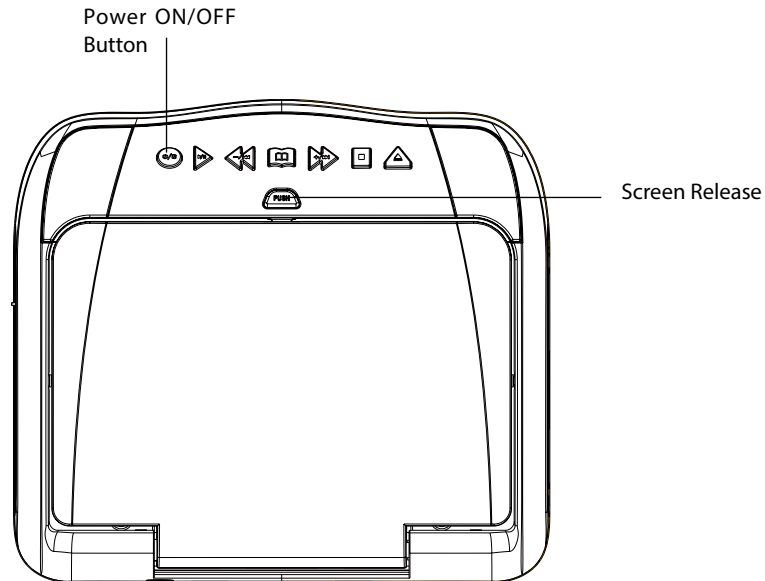
1. Push in the Screen Release button to unlock the LCD screen. The screen will drop down slightly.
2. Pivot the screen downward until a comfortable viewing angle is reached. The hinge friction will hold the screen in position while the system is in use.
3. Press the power button on the unit or the remote control to turn the system on and off. When in use, the internal backlighting will illuminate the controls.
4. After the unit has been turned on and is displaying a picture, adjust the viewing angle by pivoting the screen to optimize the picture quality.
5. Remember to turn the unit off and pivot the LCD screen to the locked position when not in use.



SOURCE MENU

The System is capable of accessing five source inputs. To select or change a source, press the source  button on the front panel or the Source button on the remote control. The source OSD will appear on the screen as shown in the figure below. Use the + or - cursor buttons on the front panel or the ▲ or ▼ cursor buttons on the remote control to highlight a source. Press the Source  button on the front panel or the OK button on the remote control to select the desired source.

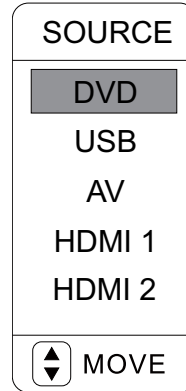

DVD

The DVD source input is used to play DVDs, Audio CDs and MP3 discs.

USB

The USB source input is used to play MP3 files, JPEG files (Photos) and MPEG I, II files.

AV

An external video source such as a video game system, or other audio/video devices can be connected to the AV input. This AV input connection is performed when the unit is installed. Turn the video source component on with its power button or remote control and it is now ready to play the audio and video signals from the source connected to the AV input.

HDMI 1 & HDMI 2

These Source inputs allow the user to enjoy high-definition digital images, video and high-quality sound by connecting an HDMI Device such as a Blu-ray player, Smartphone or Tablet. You can also use this input to connect a Smart TV Stick such as a ROKU, Amazon Fire TV or Chromecast device.

Notes:

- Connecting a Smartphone or Tablet may require a special HDMI adapter. Contact your device supplier for the appropriate HDMI device adapter.
- Smart TV devices such as ROKU, Amazon Fire TV or Chromecast devices can be plug directly into the HDMI inputs. Power for these devices can be obtained by plugging into the USB input.
- HDMI2 input, is a hidden HDMI/USB input that requires optional extension cable (model: HDH12).
- Phone functionality (phone calls, texting, etc.) may be limited while using the adapter.
- In order to access streaming content from some Smart TV devices a Wi-Fi Hotspot is required (not included with this system).

SYSTEM MENU SETTINGS AND ADJUSTMENTS

The Setup Menu contains features and options that let you customize your DVD player. For example, you can set a language for the on-screen display or set up PARENTAL controls to control DVD playback for children.

Using the System Menu

1. Press the System Menu button on the remote. The System Menu appears on the screen as shown in the figure below. There are 6 icons that will appear individually in the upper left hand corner of the System Menu as each option is selected.

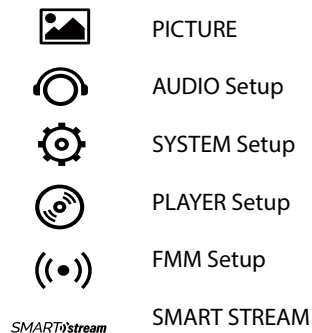
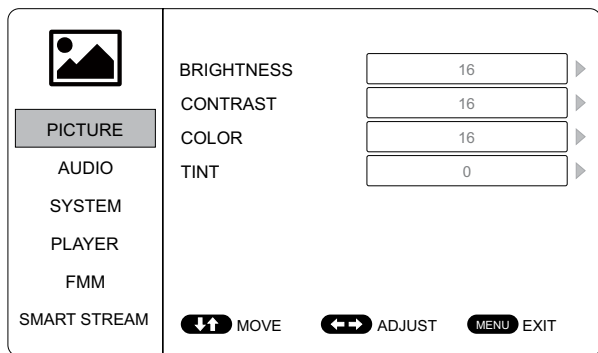

2. To select the desired setup option, move the highlighted (in blue) option using the up/down (▲▼) cursor buttons. Press the right (▶) cursor button to access the options on the right hand side of the screen.
3. After entering the setup area (on the right side of the screen), highlight the desired option using the up/down (▲▼) cursor buttons.
4. Press the right (▶) cursor button to toggle the sub menu that contains the different options available.
5. Repeat steps 3 and 4 to set the options for each option on the same Setup Page.
6. To change to another Setup page, press the system menu cursor button to the icon side of the setup page. Then, repeat steps 2 through 5.
7. If without a Remote control user can use the local key to select the function setting.
 - a.) Menu = Long press to call up the setup menu screen information or return/exit the system menu
= Short press function as Down Key
 - b.) ▶/|| Play = Enter Key
 - c.) -/⏪ = Left Key
 - d.) +/⏩ = Right Key

PICTURE CONTROL

The PICTURE setup functions allows the user to select and set the picture control function.

BRIGHTNESS, CONTRAST, COLOR adjustments range from 0 to 32.
TINT adjustments range from -16 to 16.

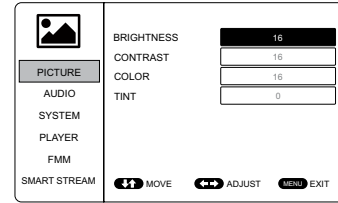

AUDIO MODE

The AUDIO setup functions allows the user to select and set the IRT Headpone transmitter "ON" or "OFF".

IRT

The IR transmitter can be set to ON or OFF. The IR Transmitter must be set to "ON" for the wireless headphone to be operational.

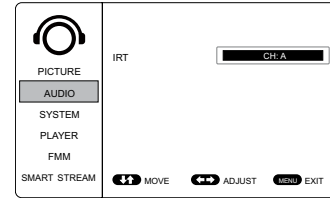

SYSTEM MODE

The system setup function allow the user to select the system function. Functions listed below.

LANGUAGE

The LANGUAGE setup allows the user to select ENGLISH, SPANISH, FRENCH, CHINESE and JAPANESE for the on-screen language display.

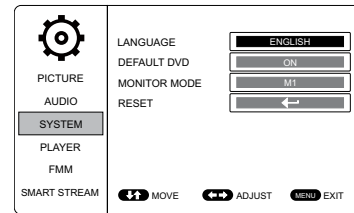

DEFAULT DVD

The DEFAULT DVD allows the user to set the system default source to DVD ON or OFF.

If source default is set to ON, every time the unit is turned off the on, the unit will power up and automatically switch the source to DVD.

If source default is set to OFF and the system is turned off then on, the unit will power up in the source that was last selected.

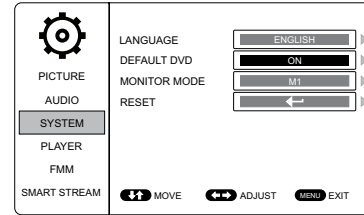

MONITOR MODE

This allows the user to change the system to M1 or M2 mode. Once the setting is changed, the remote control and IR headphones will only work if set to that same setting.

1. M1 Mode - For the Remote Control to operate the system when set to M1, press the M1 button on the Remote Control.
Please make sure IR Headphones are set to Channel A when the system is in M1 mode.
2. M2 Mode - For the Remote Control to operate the system when set to M2, press the M2 button on the Remote Control.
Please make sure IR Headphones are set to Channel B when the system is in M2 mode.

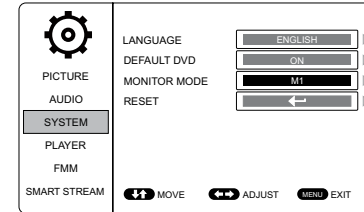

RESET

The RESET functions allows all settings options to be reset to factory settings.

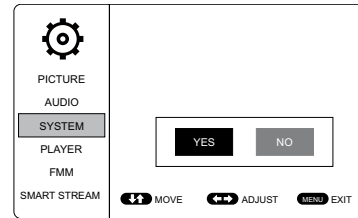
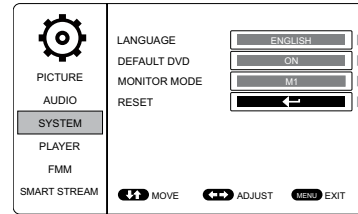

PLAYER MODE

The Player setup function allow the user to select DVD functionality.

TV SYSTEM

The TV SYSTEM setup allows the user to choose television standard which corresponds to your TV.

NTSC-Select this type for NTSC TV

PAL -Select this type for PAL TV

AUTO-Select this type if the connected screen is a multi-system TV. The video format of the disc (NTSC or PAL) will determine the video signal output.

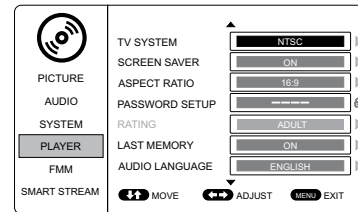

SCREEN SAVER

This allows you to set the Screen Saver mode.

ON -Screen Saver will appear

OFF -Screen Saver will not appear

Note: The DVD player will enter Screen Saver mode if the unit is inactive for approximately 2 minutes.

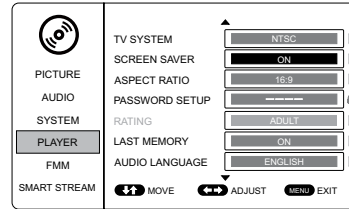

ASPECT RATIO (For DVD Screen Display)

4:3 PS (Pan Scan)

The left and right of the screen are cut off and displays the central portion of the 16:9 screen.

4:3 LB (Letter Box)

Displays the content of the DVD title in the 16:9 aspect ratio. The black bars will appear at the top and bottom of the screen.

16:9

This displays a wide picture with black bands on the upper and lower portion of the screen. The bandwidth will vary, depending on the aspect ratio of the disc.

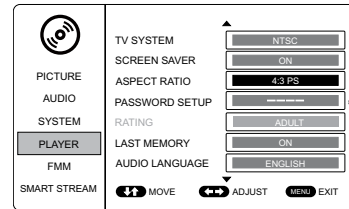

PASSWORD SETUP

The default password is 3308. To change the rating of the DVD player press 3308 to access the RATING setting.

NOTE: 3308 must be pressed to set a new password.

- Press 3308
- Enter the new 4 digit password
- Press SETUP 2 times to exit the setup mode.

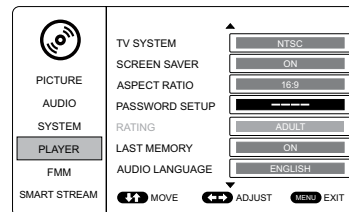

NOTE: The 3308 password is always accepted in the setup menu even after a new password has been entered. To avoid the possibility of others using the default password to set the parental level and change the password, record this default password in another area and delete it from this manual. The restriction of viewing disc content by younger users may be available on some discs, but not on others.

NOTE: When the password is set to a new password, that password must be used to play movies that have content rated above the setting in the setup menu. The user will be prompted to put the password in before the movie can play. After the password is entered press the OK button on the remote control.

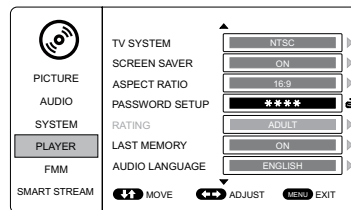

LAST MEMORY

The last memory function allows DVD playback to begin from the point when playback was last stopped. The last memory feature allows the user to turn the last memory feature function on or off.

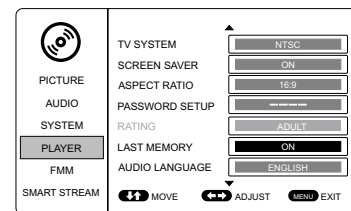

AUDIO LANGUAGE

This setting allows you to select a preferred audio language. This function only applies to discs encoded with different audio languages. Options: ENGLISH, FRENCH, SPANISH and GERMAN.

NOTE: If the selected language is not available for the currently playing disc, the disc's default setting is applied.

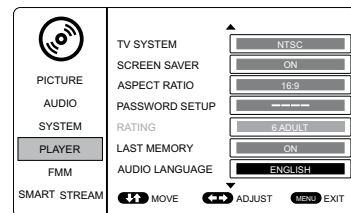

SUBTITLE LANGUAGE

This setting allows you to select a preferred subtitle language. This function only applies to discs encoded with subtitles. Options: ENGLISH, SPANISH, FRENCH, CHINESE and JAPANESE.

NOTE: If the selected language is not available for the currently playing disc, the disc's default setting is applied.

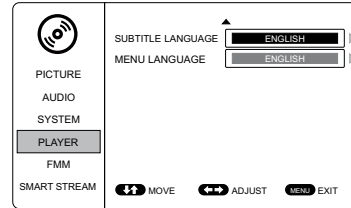

MENU LANGUAGE

This setting allows you to select a preferred disc menu language. Options: ENGLISH, SPANISH, FRENCH, CHINESE and JAPANESE.

NOTE: If the selected language is not available for the currently playing disc, the disc's default setting is applied.

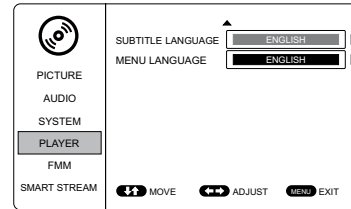

FMM MODULATION (ON/OFF)

This setting allows you to turn the FMM modulator ON or OFF.

FMM CHANNEL

This setting allows you to select the frequency. The unit has a 100 channel built-in wireless FM Modulator. The FM Modulator can be set from 88.1MHz to 107.9MHz in 0.2MHz steps, i.e.88.1,88.3,88.5,88.9,90.1 etc.

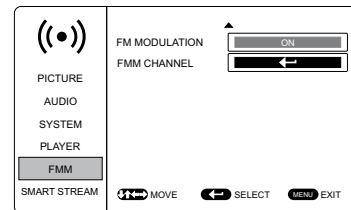
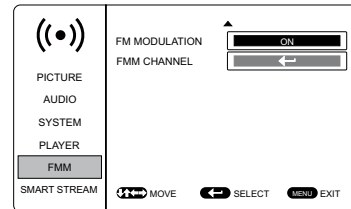

To choose an FM frequency for audio playback through your vehicle's radio:

1. Use the ▲ ▼ ◀ or ▶ cursor buttons to select a frequency not used by a radio station in the area. Press OK to select the highlighted frequency. There are a total of 3 FM CHANNEL pages containing frequencies from 88.1 MHz to 107.9 MHz in 0.2 MHz steps. To access the additional FM Channel pages, use the ◀ or ▶ cursor buttons to highlight the on screen left and right arrows and press OK. Once the frequency has been selected, tune the vehicle's radio to the selected frequency.
2. Press the DVD button to restore the remote control to DVD functions.

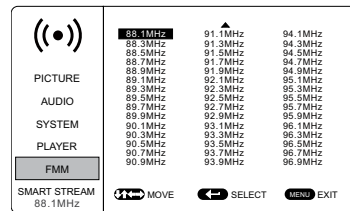

Note: The wireless FM modulator will perform well in most applications. However, in certain geographical areas the quality of the wireless signal may be less than optimal, resulting in static or strong local station bleed through. If this is a consistent problem, an FMDIRB (hard wired FM connection) can be installed by your dealer.

SMART STREAM (Optional Feature)

This setting allows you to select Wireless Streaming Display Mode. Press YES to enter the Wireless Streaming Display Mode or press NO to exit.

Note: The SmartStream Wireless Streaming Display feature will only work when optional module WM1 is connected to the system. Please refer to the SmartStream manual for user operation.

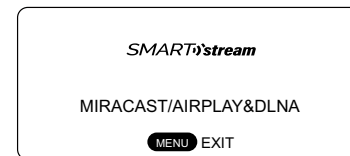
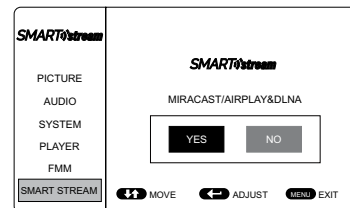

PLAYING DVD AND AUDIO DISCS

Playing DVDs

When a disc is loaded. Press the DISPLAY button on the remote control to display the status banner. The status banner includes the disc title, chapter audio language , subtitle & angle.

Title Selection: Some DVDs contain more than one title (e.g. sitcoms, collections, etc.)

Press the numeric (0-9) buttons to initiate a change of chapter title selection.

Using the repeat feature to select OFF, Chapter, Title and Repeat All to play the movies contents.

Playing Audio CDs

When playing an audio CD, the DISPLAY banner appears automatically. The track number and the elapsed time of the disc are displayed.

Selecting a Track: Selection of a specific track is accomplished by using the numbers keys. Press the number key corresponding to the desired track and the player will implement the selection.

- Press the previous button (⏮) to return to the previous chapter or track.
- Press the next button (⏭) to skip to the next chapter or track.

Using the REPEAT feature

The default mode for the Repeat feature is OFF. Pressing REPEAT on the remote control consecutively changes the repeat options.

- OFF Plays all songs on the disc and stops after all songs are played
- REP 1 Repeats 1 song
- REP DIR Plays songs in the directory
- REP ALL Plays all songs on the disc repeatedly

Playing USB Devices

To play a USB device, change the source to USB and plug a USB device into the USB port. When a USB device is inserted into the player the navigation menu appears automatically.

Use the cursor keys ▲ ▼ ◀ ▶ and OK to navigate the on screen menus.

The USB port can play AUDIO, PHOTO, VIDEO . The following formats are supported:

Audio

- MP3
- WMA
- AAC

Photo

- JPEG
- BMP

Video*

- AVI (MPEG4-DIVX (DIVX 4.0/5.0), MPEG4-XVID - (720 x 576 max resolution)
- MPG (MPEG-1) - (720 x 576 max resolution)
- MOV (MPEG4-DIVX) - (720 x 576 max resolution)
- FLV (FLV1) - (720 x 576 max resolution)
- SWF (FLV1) - (720 x 576 max resolution)
- DAT (MPEG1) - (720 x 576 max resolution)
- VOB (MPEG2) - (720 x 576 max resolution)

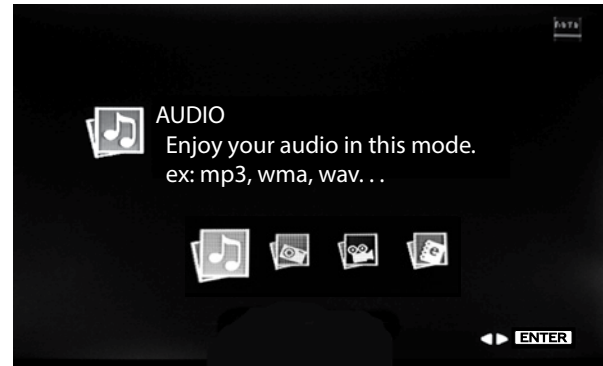

Note: All formats may not play depending on the software used to convert the video file from its original format.

Playing MP3 Discs

MP3 is a format for storing digital audio. An audio CD-quality song can be compressed into MP3 format with very little loss of quality, while taking up much less space. CD-R discs that have MP3 format files can be played on the DVD player. The DVD player plays the songs in the order they were burned on to the disc.

Selecting Folders and Songs:

When an MP3 disc is loaded in the player, the navigation menu will appear on the screen automatically and a song will start playing.

To change songs use the ▲▼ arrows to select a different song and press the OK or ⏪ button to play the selected song. To change folders press the ▲ button to move to the root folder and press the OK or ⏪ button to display all the folders on the disc. Use ▲▼ the buttons to select a new folder and press the OK or ⏪ button to enter the new folder. The unit will begin playing the first song of the folder.

DVD BASICS

To get the optimum use out of the DVD Player, please read the following:

DVD Region Code

The DVD player is preset to a region code at the factory depending on where the DVD player is sold. A DVD from a different region cannot be played in this unit and the unit will display "WRONG REGION".

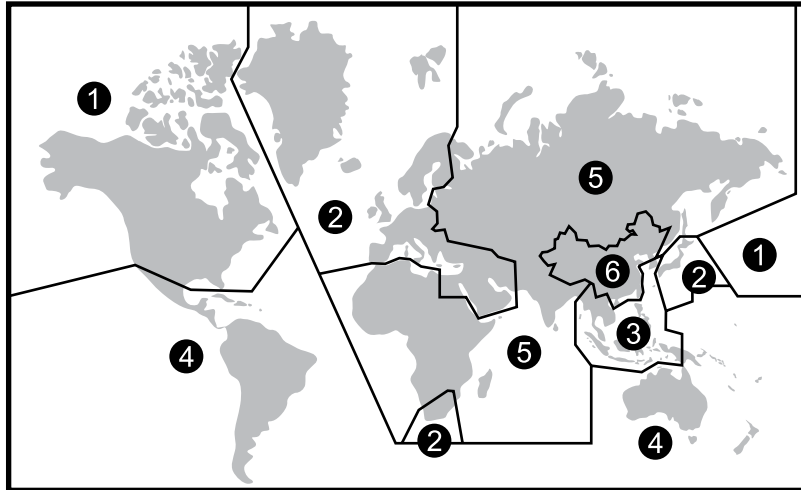

Region 1- USA, Canada

Region 2- Japan, Europe, South Africa, Middle East, Greenland

Region 3- S. Korea, Taiwan, Hong Kong, Parts of South East Asia

Region 4- Australia, New Zealand, Latin America (including Mexico)

Region 5- Eastern Europe, Russia, India, Africa

Region 6- China

HDMI Device

HDMI1 (HDMI Input located on the side of the unit)

This input can be used for devices with HDMI output ports (such as smartphones, tablets, HDMI devices) and may require the purchase of an HDMI cable and HDMI adapter which is available from your device manufacturer. Each device has unique requirements, please consult with your device or smartphone manufacturer to determine which type of output your device supports.

NOTE: Smart devices connected to the HDMI input may require power which can be accessed from the USB input of the system.

HDMI2 (optional hidden HDMI/USB input)

This is a hidden input which requires optional cable, model HDH12. This input will allow the same connectivity options as the HDMI1 input.

Smartphones and Tablets

For Apple products, go to the Apple Store or enter the following link into your web browser to find the adapter required for your device. Different models require different adapters.

• <http://support.apple.com/kb/ht4108> *



See the following links for other smartphone and tablet manufacturers:

Samsung Multimedia adapter:

• <http://www.samsung.com/us/mobile/cell-phones-accessories/multimedia-adapters>



NOTE: Some Samsung smartphones may require an additional 5-pin micro USB to 11-pin micro USB adapter in addition to the multimedia adapter.

For other smartphone makes and models check with your device service provider to find an adapter that will work with your device.

HDMI Devices **:

Amazon Fire TV media streaming device:

• <https://www.amazon.com/Fire-TV-Stick>



Chromecast media streaming device:

• www.google.com and search for Chromecast



Roku HDMI streaming device:

• <http://www.roku.com/products/compare>



NOTE:

* Web links can change over time; if the above links do not function go to your device manufacturer's or smartphone service provider's web site for more information.

** These devices require connection to Wi-Fi or a hotspot in order to stream video content from providers such as Netflix, Hulu, Prime Video, etc.

Caution: Streaming video can consume large amounts of data when a smartphone is used as a hotspot. Data rates may apply. See your mobile phone service provider for details.

USB INPUTS

USB1 Port (User Accessible)

The USB port provides two functions:

1. Media port for USB thumb drives:
2. charging:
 - The USB port will not charge a portable device when the unit is turned OFF.
 - The USB port will charge a portable device in the following modes:
 - DVD/USB (Not recommended)
 - AV
 - AUX
 - HDMI
 - It will not charge in USB mode.
 - For Apple /Android Mobile , It will charge at up to 1 Amps of charging current.
 - For Samsung Mobile, It will charge at up to 500mA of charging current.

USB2 Port (Hidden Input for when remote HDMI/USB Harness HDH12 is Installed)

1. The USB port charging only.
2. Max Charging current
For Apple /Android Mobile , It will charge at up to 1 Amps of charging current.
For Samsung Mobile, It will charge at up to 500mA of charging current.
3. Charging is available in all source.
4. USB2 is not a source, so it can't be selected in the Main Menu or Source.

TROUBLESHOOTING

Problem	Solution
IR remote inoperative	<ul style="list-style-type: none"> • Verify that the battery in the remote is fresh. • Verify that the remote sensor eye is not obstructed. • Verify the proper mode (DVD/TV) button is selected on the remote control.
Disc won't play	<ul style="list-style-type: none"> • Insert a disc with the label side facing upwards. • Check the type of disc you put into disc tray. This DVD only plays DVD, audio CD and MP3. Blu-ray (BD) discs will not play in this player. • Both the unit and the disc are coded by region. If the regional codes don't match, the disc can't be played.
Play starts, but then stops immediately	<ul style="list-style-type: none"> • The disc is dirty. Clean it. • The disc is damaged. Try another disc. • Condensation has formed. Allow player to dry out.
No sound or distorted sound	<ul style="list-style-type: none"> • Make sure the DVD is connected properly. Make sure all cables are securely inserted into the appropriate jacks. • If the 2-channel IR headphones are being used, turn on the IR headphone power, and make sure the correct channel (A-B) is selected. • If the FM Modulator is ON make sure proper frequency has been selected.
Cannot advance through a movie	<ul style="list-style-type: none"> • You can't advance through the opening credits and warning information that appears at the beginning of a movie because the disc is programmed to prohibit that action.
The icon (⓪) appears	<ul style="list-style-type: none"> • The feature or action cannot be completed at this time because: <ol style="list-style-type: none"> 1. The disc's software restricts it. 2. The disc's software doesn't support the feature (e.g., angles) 3. The feature is not available at the moment. 4. A title or chapter number that is out of range has been requested.
Picture is distorted	<ul style="list-style-type: none"> • The disc might be damaged. Try another disc. • It is normal for some distortion to appear during forward or reverse scan.
No forward or reverse scan	<ul style="list-style-type: none"> • Some discs have sections that prohibit rapid scanning or title and chapter skip. • If you try to skip through the warning information and credits at the beginning of a movie, you won't be able to. This part of the movie is often programmed to prohibit skipping through it.
HDMI input not working for the HDMI enabled device	<ul style="list-style-type: none"> • May require a special HDMI adapter. Contact your HDMI device supplier for the adapter. • Some devices may need to boot up before showing picture. • Ensure you are using an OEM branded (Apple, Samsung, etc.) adapter. Generic adapters may not function properly with your device.
NO SIGNAL displayed on screen	<ul style="list-style-type: none"> • No source plugged into the A/V, MEDIA or HDMI input. • Some devices may need to boot up before showing picture.

SPECIFCAITONS

Type	TFT Active Matrix LCD
Resolution	1024 (RGB) (X3) x 600
Pixels	1,843,200
Operation Temperature	32 ~ 131° F (0 ~ 55° C)
Storage Temperature	-4 ~ 158° F (-20 ~ 70° C)
Backlit life	20,000 Hours
Video Display System	NTSC / PAL / AUTO
Video Output	1.0Vp-p @ 75 ohms
Power Source	12VDC
Dimension (L x W x H)	301mm x 271mm x 74mm 11.9in x 10.7in x 2.9in



LIMITED WARRANTY

Applies to VOXX Mobile Video Products

ADVP10 VODP10
ROSP10 INVP10

VOXX ELECTRONICS CORP. (the Company) warrants to the original retail purchaser of this product that, should this product or any part thereof (except game controllers), under normal use and conditions, be proven defective in material or workmanship within 36 months from the date of original purchase, such defect(s) will be repaired or replaced with reconditioned product (at the Company's option) without charge for parts and repair labor.

If your new vehicle's radio, CD/DVD player is covered by the manufacturer's warranty for a period of 48 months as set forth in the OEM Warranty Booklet, the company will extend the Advent Mobile Video product warranty for the same period of time. This is not applicable to extended warranty purchases beyond the original manufacturer's warranty. A game controller, if supplied, is similarly warranted for ninety (90) days.

To obtain repair or replacement within the terms of this Warranty, the product is to be delivered with proof of warranty coverage (e.g. dated bill of sale), specification of defect(s), transportation prepaid, to the Company at the address shown below.

This Warranty does not extend to the elimination of externally generated static or noise, to correction of antenna problems, to costs incurred for installation, removal or reinstallation of the product, or to damage to digital memory/media devices, gaming devices, discs, speakers, accessories, or vehicle electrical systems.

This Warranty does not apply to any product or part thereof which, in the opinion of the Company, has suffered or been damaged through alteration, improper installation, mishandling, misuse, neglect, accident, or by removal or defacement of the factory serial number/bar code label(s). **THE EXTENT OF THE COMPANY'S LIABILITY UNDER THIS WARRANTY IS LIMITED TO THE REPAIR OR REPLACEMENT PROVIDED ABOVE AND, IN NO EVENT, SHALL THE COMPANY'S LIABILITY EXCEED THE PURCHASE PRICE PAID BY PURCHASER FOR THE PRODUCT.**

This Warranty is in lieu of all other express warranties or liabilities. **ANY IMPLIED WARRANTIES, INCLUDING ANY IMPLIED WARRANTY OF MERCHANTABILITY, SHALL BE LIMITED TO THE DURATION OF THIS WRITTEN WARRANTY. ANY ACTION FOR BREACH OF ANY WARRANTY HEREUNDER INCLUDING ANY IMPLIED WARRANTY OF MERCHANTABILITY MUST BE BROUGHT WITHIN A PERIOD NOT EXCEEDING 12 MONTHS AFTER EXPIRATION OF THE WARRANTY. IN NO CASE SHALL THE COMPANY BE LIABLE FOR ANY CONSEQUENTIAL OR INCIDENTAL DAMAGES FOR BREACH OF THIS OR ANY OTHER WARRANTY, LOSS OF REVENUE OR LOSS OF ACTUAL OR ANTICIPATED PROFITS (INCLUDING LOSS OF PROFITS ON CONTRACTS).** No person or representative is authorized to assume for the Company any liability other than expressed herein in connection with the sale of this product.

Some states do not allow limitations on how long an implied warranty lasts or the exclusion or limitation of incidental or consequential damage so the above limitations or exclusions may not apply to you. This Warranty gives you specific legal rights and you may also have other rights which vary from state to state.

2020 VOXX ELECTRONICS CORPORATION, 2351 J Lawson Blvd., Orlando FL. 32824



For Customer Service
Visit Our Website At
www.voxxelectronics.com
Product Information, Photos,
FAQ's, Owner's Manuals

