

RCA

user **manual**

TH1401



It is important to read this instruction book prior to using your new product for the first time.

Table of Contents



Quick reference	3
Important Information	4
End User License Agreement	6
Before You Begin	8
Unpacking your player	8
Things to consider before you get started... ..	9
Computer system requirements	9
Warning	9
Caution	9
Caution while driving	9
Back up your data	9
Getting Started	10
Inserting the battery	10
Connecting to a computer	10
Removing the player from your computer	11
Powering on/off	12
Controls and Display	13
Controls	13
Display	14
Transferring Music	15
Install Windows Media Player	15
Adding Audio Files to your Library	16
Converting CD Tracks to mp3	17
Converting CD Tracks to wma	19
Transferring Audio Files to your Player	20
Editing Lyrics	21
Deleting files from the player	21
Using the Player as a Mass Storage Device	22
Performing a Backup	23
Creating Playlist Folders	24
Playback	25
Listening to your mp3/wma files	25
Volume	25
Locking your Player	25
Synchronizing Lyrics Display	26
File Browsing	27
Menu Structure	27
Navigation	27
Recording	29
Recording from the Built-in Microphone	29
Adjusting Recording Settings	29
Playback of Voice Recording	30
Settings	31
Adjusting Settings	31
Equalizer	31
Repeat Mode	31
Contrast	32
Backlight	32
Power Saving	32
Default Settings	33
Language	33
Information about the Player	33

Advanced Features	34
Upgrading your Player	34
Formatting the player	35
Additional Information	36
Troubleshooting	36
Specifications	37
Limited warranty	39

Quick reference

Backlight	32	Recording (playback)	30
Backup data	23	Recording (settings)	29
Battery (installing)	10	Recording	29
Computer system requirements	9	Removing the player from the computer	11
Connecting to the computer	10	Repeat mode	31
Contrast	32	Ripping CD	17
Converting CD tracks to WMA	19	Specifications	37
Default settings	33	Transfer audio files to the player	20
Deleting files	21	Upgrading player	34
Display	14	Volume control	25
Equalizer	31	Windows Media Player (adding audio files)	16
File browsing	27	Windows Media Player (Installing)	15
Formatting player	35		
General controls	13		
Information	33		
Language	33		
Locking the player	25		
Lyric (edit)	21		
Lyric (synchronizing)	26		
Mass storage device	22		
Menu navigation	27		
Menu structure	27		
Microphone	29		
Playback	25		
Playlist folders	24		
Power on/off	12		
Power saving	32		

Important Information

 THE LIGHTNING FLASH AND ARROW-HEAD WITHIN THE TRIANGLE IS A WARNING SIGN ALERTING YOU OF "DANGEROUS VOLTAGE" INSIDE THE PRODUCT.	CAUTION RISK OF ELECTRIC SHOCK DO NOT OPEN CAUTION: TO REDUCE THE RISK OF ELECTRIC SHOCK, DO NOT REMOVE COVER (OR BACK). NO USER-SERVICEABLE PARTS INSIDE. REFER SERVICING TO QUALIFIED SERVICE PERSONNEL.	 THE EXCLAMATION POINT WITHIN THE TRIANGLE IS A WARNING SIGN ALERTING YOU OF IMPORTANT INSTRUCTIONS ACCOMPANYING THE PRODUCT.
SEE MARKING ON BOTTOM / BACK OF PRODUCT		

WARNING: TO PREVENT FIRE OR ELECTRICAL SHOCK HAZARD, DO NOT EXPOSE THIS PRODUCT TO RAIN OR MOISTURE.

To reduce risk of injury, charge only rechargeable batteries recommended by the manufacturer for this player. Other types of batteries may burst causing damage and personal injury.

Technical specification

Product: RCA player

Brand: RCA

Model: TH1401

Electrical rating

DC : 1.5V AAA/LR03 battery

ESD Remark:

In case of malfunction due to electrostatic discharge just reset the product (disconnect and reconnect of the power source may be required) to resume normal operation.

Important Information

FCC Regulations state that unauthorized changes or modifications to this equipment may void the user's authority to operate it.

FEDERAL COMMUNICATIONS COMMISSION INFORMATION

This device complies with Part 15 of the FCC Rules. Operation is subject to the following two conditions: (1) This device may not cause harmful interference, and (2) this device must accept any interference received, including interference that may cause undesired operation.

This equipment has been tested and found to comply with the limits for a Class B digital device, pursuant to Part 15 of FCC Rules. These limits are designed to provide reasonable protection against harmful interference in a residential installation. This equipment generates, uses, and can radiate radio frequency energy and, if not installed and used in accordance with the instructions, may cause harmful interference to radio communications. However, there is no guarantee that interference will not occur in a particular installation. If this equipment does cause harmful interference to radio or television reception, which can be determined by turning the equipment off and on, the user is encouraged to try to correct the interference by one or more of the following measures

- Reorient or relocate the receiving antenna.
- Increase the separation between the equipment and receiver.
- Connect the equipment into an outlet on a circuit different from that to which the receiver is connected.
- Consult the dealer or an experienced radio/ TV technician for help.

In accordance with FCC requirements, changes or modifications not expressly approved by Thomson Inc. could void the user's authority to operate this product.

This Class B digital apparatus complies with Canadian ICES-003.
Cet appareil numérique de la class B est conforme à la norme du NMB-003 du Canada

Manufacturer/Responsible Party

Thomson, Inc.
P.O. Box 1976
Indianapolis, IN 46206-1976
(317) 587-3001

End User License Agreement

IMPORTANT: READ CAREFULLY BEFORE DOWNLOADING OR INSTALLING THIS SOFTWARE!

THIS END USER LICENSE AGREEMENT (THIS "EULA") IS A LEGAL AGREEMENT BETWEEN YOU AND THOMSON INC., OR ANY THOMSON GROUP ENTITY, AS DEFINED BELOW (COLLECTIVELY "THOMSON ENTITY"), FOR THE RCA OR THOMSON BRANDED PORTABLE DIGITAL AUDIO/VIDEO DEVICE APPLICATION/DRIVER SOFTWARE PROGRAM AND ASSOCIATED DOCUMENTATION, IF ANY (COLLECTIVELY, THE "PROGRAM"). THIS EULA CONTAINS IMPORTANT LEGAL LIMITATIONS, RESTRICTIONS AND DISCLAIMERS, AND ALSO SPECIFIES THE DURATION OF YOUR LICENSE.

BY INSTALLING THE PROGRAM OR CLICKING ON THE ACCEPTANCE BUTTON OF THE PROGRAM, COPYING OR OTHERWISE USING THE PROGRAM, YOU ACKNOWLEDGE AND AGREE THAT YOU HAVE READ THIS EULA, UNDERSTAND IT, AND AGREE TO BE BOUND BY ITS TERMS AND CONDITIONS. YOU MAY USE THE PROGRAM ONLY IN ACCORDANCE WITH THIS EULA, AND ANY SUCH USE IS HEREBY UNDERSTOOD TO BE CONDITIONAL UPON YOUR SPECIFIC AGREEMENT TO THE UNMODIFIED TERMS SET FORTH HEREIN. IF YOU DO NOT AGREE WITH ALL OF THE TERMS OF THIS EULA, CLICK ON THE REJECTION BUTTON AND/OR DO NOT INSTALL THE PROGRAM AND/OR DO NOT USE THE PROGRAM.

1. LICENSE

- (a) Under this EULA, you are granted a license (i) to use the Program on a single workstation, and (ii) to make one (1) copy of the Program into any machine-readable form for backup of the Program, provided the copy contains all of the original Program's proprietary notices.
- (b) You may transfer the Program and license to another party only as a part of the Thomson/RCA branded Portable Digital Audio/Video Device ("A/V Device"), and only if the other party agrees to accept the terms and conditions of this EULA. If you transfer the Program, you must at the same time either transfer all copies to the same party or destroy any copies not transferred.
- (c) The terms of this EULA will govern any software upgrades or updates provided by THOMSON Entity that replace and/or supplement the original Program, unless such upgrade or update is accompanied by separate license terms and conditions in which case the terms of that separate license will govern. You acknowledge and agree that THOMSON Entity may automatically download upgrades or updates to the Program software to your computer in order to update, enhance, and/or further develop the Program.

2. LICENSE RESTRICTIONS

- (a) Except for the licenses expressly granted to you in this EULA, no other licenses or rights are granted or implied.
- (b) You may not (i) make the Program available over a network where it could be used by multiple computers at the same time; (ii) modify, translate, reverse engineer, decompile, disassemble (except to the extent that this restriction is expressly prohibited by law), or create derivative works based upon the Program; or (iii) copy the Program, except as expressly permitted herein. You agree that you shall only use the Program in a manner that complies with all applicable laws in the jurisdictions in which you use the Program, including, but not limited to, applicable restrictions concerning copyright and other intellectual property rights.
- (c) The Program may contain pre-release code that does not perform at the level of a final code release. In such case, the

Program may not operate properly. Updated versions of the Program may be downloaded from www.rcaaudiovideo.com/digitalaudiosupport.

- (d) THOMSON Entity is not obligated to provide support services for the Program.
- (e) The Program is provided with "RESTRICTED RIGHTS". Use, duplication, or disclosure by the U.S. Government is subject to restrictions as set forth in subparagraph (c)(1)(ii) of DFARS 252.227-7013, or FAR 52.227-19, or in FAR 52.227-14 Alt. III, as applicable.

3. TERM AND TERMINATION

- (a) Your license is effective on the date you accept this EULA and remains in effect until this EULA is terminated by either party.
- (b) You may terminate this EULA and the associated license, without any notice or delay, by destroying or permanently erasing the Program and all copies thereof.
- (c) If you fail to comply with any of the terms of this EULA, in whole or part, your license will automatically terminate without notice from THOMSON Entity.
- (d) Upon termination of this EULA and your associated license, you shall cease all use of the Program and destroy or permanently erase the Program and all full or partial copies thereof.

4. WARRANTY DISCLAIMER

THE PROGRAM IS PROVIDED "AS IS" WITHOUT WARRANTY OF ANY KIND, EITHER EXPRESSED OR IMPLIED, INCLUDING, BUT NOT LIMITED TO THE IMPLIED WARRANTIES OF MERCHANTABILITY, FITNESS FOR A PARTICULAR PURPOSE, TITLE OR NON-INFRINGEMENT. THE ENTIRE RISK AS TO THE QUALITY AND PERFORMANCE OF THE PROGRAM IS WITH YOU. SHOULD THE PROGRAM PROVE DEFECTIVE, YOU (AND NOT THOMSON ENTITY, ITS SUPPLIERS, OR ITS DEALERS) ASSUME THE ENTIRE COST FOR ALL NECESSARY REPAIR OR CORRECTION.

This exclusion of warranty may not be allowed under some applicable laws. As a result, the above exclusion may not apply to you, and you may have other rights depending on the law that applies to you.

5. OWNERSHIP RIGHTS

All title and intellectual property rights in and to the Program and any copies thereof are owned by THOMSON Entity or its suppliers. All title and intellectual property rights in and to the content which may be accessed through use of the Program is the property of the respective content owner and may be protected by applicable copyright or other intellectual property laws and treaties. This license grants you no rights to use such content.

6. LIMITATION OF LIABILITY

(a) TO THE MAXIMUM EXTENT PERMITTED BY APPLICABLE LAW, IN NO EVENT SHALL THOMSON ENTITY, OR ITS DEALERS BE LIABLE FOR ANY SPECIAL, INCIDENTAL, INDIRECT, OR CONSEQUENTIAL DAMAGES WHATSOEVER (INCLUDING, WITHOUT LIMITATION, DAMAGES FOR LOSS OF PROFITS, BUSINESS INTERRUPTION, CORRUPTION OF FILES, LOSS OF BUSINESS INFORMATION, OR ANY OTHER PECUNIARY LOSS) REGARDLESS OF CAUSE OR FORM OF ACTION, INCLUDING CONTRACT, TORT, OR NEGLIGENCE, ARISING OUT OF YOUR USE OF OR INABILITY TO USE THE PROGRAM, EVEN IF THOMSON ENTITY HAS BEEN ADVISED OF THE POSSIBILITY OF SUCH DAMAGES. BECAUSE SOME STATES AND JURISDICTIONS DO

End User License Agreement

NOT ALLOW THE EXCLUSION OR LIMITATION OF LIABILITY OF CONSEQUENTIAL OR INCIDENTAL DAMAGES, THE ABOVE LIMITATION MAY NOT APPLY TO YOU.

(b) YOU ASSUME RESPONSIBILITY FOR THE SELECTION OF THE APPROPRIATE PROGRAM TO ACHIEVE YOUR INTENDED RESULTS, AND FOR THE INSTALLATION, USE, AND RESULTS OBTAINED.

7. WINDOWS MEDIA

The software embedded within your A/V Device (the "Device Firmware") contains software licensed from Microsoft that enables you to play Windows Media Audio (WMA) files ("WMA Software"). The WMA Software is licensed to you for use with your A/V Device under the following conditions. By installing and using this version of the Device Firmware, you are agreeing to these conditions. IF YOU DO NOT AGREE TO THE END USER CONDITIONS OF THIS SECTION 7, DO NOT INSTALL OR USE THIS VERSION OF THE DEVICE FIRMWARE. The WMA Software is protected by copyright and other intellectual property laws. This protection also extends to documentation for the WMA Software, whether in written or electronic form.

GRANT OF LICENSE. The WMA Software is only licensed to you as follows:

You may use this version of the Device Firmware containing the WMA Software only as such use relates to your A/V Device. You may not reverse engineer, decompile, or disassemble the WMA Software, except and only to the extent that such activity is expressly permitted by applicable law.

You may transfer your right to use the Device Firmware only as part of a sale or transfer of your A/V Device, on the condition that the recipient agrees to the conditions set forth herein. If the version of the Device Firmware that you are transferring is an upgrade, you must also transfer all prior versions of the Device Firmware that you have which include the WMA Software.

MICROSOFT IS NOT PROVIDING ANY WARRANTY OF ANY KIND TO YOU FOR THE WMA SOFTWARE, AND MICROSOFT MAKES NO REPRESENTATION CONCERNING THE OPERABILITY OF THE WMA SOFTWARE.

The WMA Software is of U.S. origin. Any export of this version of the Device Firmware must comply with all applicable international and national laws, including the U.S. Export Administration Regulations, that apply to the WMA Software incorporated in the Device Firmware.

Content providers are using the digital rights management technology for Windows Media contained in your A/V Device ("WM-DRM") to protect the integrity of their content ("Secure Content") so that their intellectual property, including copyrights, in such content is not misappropriated. Your A/V Device uses WM-DRM software to play Secure Content ("WM-DRM Software"). If the security of the WM-DRM Software in your A/V Device has been compromised, owners of Secure Content ("Secure Content Owners") may request that Microsoft revoke the WM-DRM Software's right to acquire new licenses to copy, display, and/or play Secure Content. Revocation does not alter the WM-DRM Software's ability to play unprotected content. A list of revoked WM-DRM Software is sent to your A/V Device whenever you download a license for Secure Content from the Internet or from a computer. Microsoft may, in conjunction with such license, also download revocation lists onto your A/V Device on behalf of Secure Content Owners.

8. THIRD PARTY SOFTWARE

ANY THIRD PARTY SOFTWARE THAT MAY BE PROVIDED WITH THE PROGRAM IS INCLUDED FOR USE AT YOUR OPTION. IF YOU CHOOSE TO USE SUCH THIRD PARTY SOFTWARE, THEN SUCH USE SHALL BE GOVERNED BY SUCH THIRD PARTY'S LICENSE AGREEMENT, AN ELECTRONIC COPY OF WHICH WILL BE INSTALLED IN THE APPROPRIATE FOLDER ON YOUR COMPUTER UPON INSTALLATION OF THE SOFTWARE. THOMSON ENTITY IS NOT RESPONSIBLE FOR ANY THIRD PARTY'S SOFTWARE AND SHALL HAVE NO LIABILITY FOR YOUR USE OF THIRD PARTY SOFTWARE.

9. GOVERNING LAW

If you acquired this A/V Device in the United States, this EULA shall be governed and construed in accordance with the laws of the State of Indiana, U.S.A. without regard to its conflict of laws principles. If you acquired this A/V Device outside the United States or the European Union, then local law may apply.

10. GENERAL TERMS

This EULA can only be modified by a written agreement signed by you and THOMSON Entity, and changes from the terms and conditions of this EULA made in any other manner will be of no effect. If any portion of this EULA shall be held invalid, illegal, or unenforceable, the validity, legality, and enforceability of the remainder of the Agreement shall not in any way be affected or impaired thereby. This EULA is the complete and exclusive statement of the agreement between you and THOMSON Entity, which supersedes all proposals or prior agreements, oral or written, and all other communications between you and THOMSON Entity, relating to the subject matter of this hereof. "THOMSON Group Entity" when used in this EULA shall mean any person, corporation, or other organization, domestic or foreign, including but not limited to subsidiaries, that is directly or indirectly controlled by Thomson S.A. For purposes of this definition only, the term "control" means the possession of the power to direct or cause the direction of the management and policies of an entity, whether by ownership of voting stock or partnership interest, by contract, or otherwise, including direct or indirect ownership of more than fifty percent (50%) of the voting interest in the entity in question.

Before You Begin

Dear RCA Customer,

Thank you for purchasing the RCA Player. This player will play open mp3 and Windows Media™ audio (WMA) content as well as content purchased from most online music download services.

After purchasing and downloading music to your PC, you are now ready to move content to your player. To transfer the music to your player, you may use Windows Media Player or the application recommended by the online music download service.

(Note: Services and applications must be Windows Media audio-compliant and support Digital Rights Management. Windows® 2000 or Windows® XP (SP1 or higher) required.)

Unpacking your player

Your player came with everything you need to make music portable — all of the items shown below should have been packed in the box with your player.



- RCA Player



- 1 x AAA battery



- Quick Start Guide



- Earphones

- Registration card

- User Manual Softcopy

This document is stored inside the player and can be downloaded at <http://www.rcaaudiovideo.com/downloads>

Explore a world of accessories! Jump on the Internet and go to www.rcaaudiovideo.com to discover the additional accessories that are available for your player.

Illustrations contained within this publication are for representation only and subject to change.

Before You Begin

Things to consider before you get started...

Computer system requirements

- Pentium III 500MHz or higher recommended
- Microsoft Windows® XP or Windows® 2000
- Internet Explorer 6.0 or higher
- Internet access (broadband recommended)
- 250MB free hard disk space for the software
- 128MB RAM (256MB recommended)
- CD drive capable of digital audio extraction
- USB port (2.0 recommended)
- Sound card

Warning

Use of this player is for your personal use only. Unauthorized recording or duplication of copyrighted material may infringe upon the rights of third parties and may be contrary to copyright laws.

Caution

- Keep player out of direct sunlight. Exposure to direct sunlight or extreme heat (such as inside a parked car) may cause damage or malfunction.
- Do not expose to rain or moisture.

Caution while driving

Use of headphones while operating an automobile or moving vehicle is not recommended and is unlawful in some states and areas. Be careful and attentive on the road. Stop operation of the player if you find it disruptive or distracting while driving.

Back up your data

As with any portable device with internal memory or storage, you must back up the data regularly. RCA and Thomson are not responsible for lost data.

Getting Started

Installing the Battery



1. Remove the USB port cover.
2. Push and slide out the battery compartment cover.
3. Install the battery. Match the + and - signs on the battery to the signs on the battery compartment.
4. Re-install the battery compartment cover.

Connecting to the Computer



Caution: BEFORE YOU START

- Make sure that the player is off and disconnect the earphones.
- Make sure the player is not locked. If the player is locked while you power it on, the screen displays "Locked" and the player will automatically power off after a few seconds.



Getting Started

1. Remove the USB port cover and disconnect the earphones.
2. Connect the player to one of your computer's USB ports.
3. The screen displays "USB Connected", indicating that the player is in USB mode.
4. On your computer's desktop, right-click on the My Computer icon and select Explore. The player will be automatically recognized as a removable media device (Microsoft® Windows® 2000 and XP).



5. Transfer files to or from the player using Windows Explorer. To do so, drag and drop your files to the player as shown below:

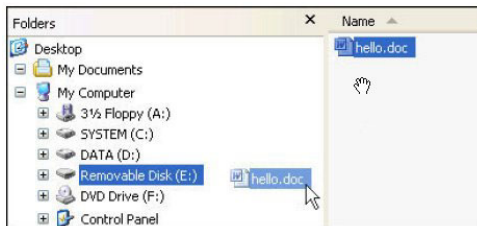

Note: You can also organize your music files into folders before transferring them to your player. – refer to page 24.

Removing the player from your computer

1. Right-click on the Safely Remove Hardware icon  in the taskbar (next to the clock).
2. Click on Safely Remove USB Mass Storage Device.
3. Wait until a Safe to Remove Hardware message is displayed.

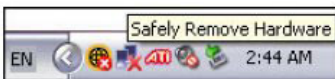

4. Remove the player.

Getting Started

Powering ON/OFF



Caution: Before turning on the player, make sure the player is not locked. If your player is locked when you power it on, the screen displays “Locked” and your player automatically turns off after a few seconds. To unlock it, simply slide the hold switch backwards.

- To power on your player, press ►|| briefly .
- To power off, press and hold ■ until the progress bar is full and the screen turns black.

Caution

- When storing the unit, be sure to remove the battery because it may leak and damage the unit.
- Battery may leak electrolyte if inserted incorrectly, if disposed of in fire, or if an attempt is made to charge a battery not intended to be recharged.
- Discard leaky batteries immediately. Leaking batteries may cause skin burns or other personal injury.
- Do not charge batteries which are not intended to be recharged.
- Dispose of batteries, according to federal, state and local regulations.



Caution:

- Risk of explosion if battery is replaced by an incorrect type.
- Dispose of used batteries according to the instructions.

Controls and Display

Controls

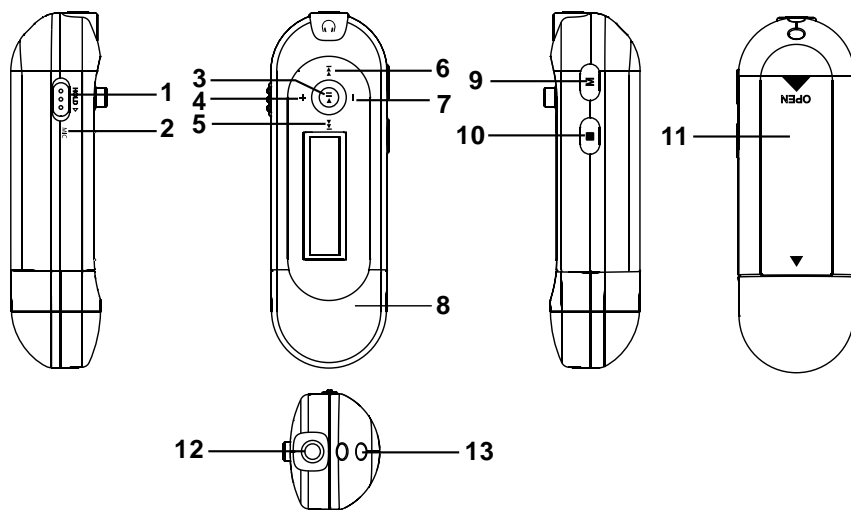

1. **HOLD** (hold switch)

- Slide to lock the controls and prevent any accidental operation while recording or playing.
- Slide backward to unlock.

2. **MIC** Microphone

3. **▶||** Play / Pause / Power On

- Press to turn the player on.
- In playback mode, press to play a track. During playback, press to pause and again to resume playback.
- In browsing mode, slide up/down/right/left to scroll.

4. **+** Volume up

- Slide the **▶||** button to **+** to increase the volume level.

5. **⏮** Skip backward / Fast rewind

- Slide the **▶||** button to **⏮** to go to the previous file/menu item; slide and hold to fast-rewind a file.

6. **⏭** Skip Next / Fast Forward

- Slide the **▶||** button to **⏭** to go to the next file/menu item; slide and hold to fast-forward a file.

Controls and Display

7. – Volume down

- Slide the ►| button to – to decrease the volume level.

8. USB Port Cover

9. **M** Menu button

- Press to access the Main Menu (Music, Record, Voice, Navigation, Settings).

10. ■ Stop / Power Off

- Press to stop playback. Press and hold to turn the player off.

11. Battery compartment

12. Headphone jack

13. Neck strap hole

Display

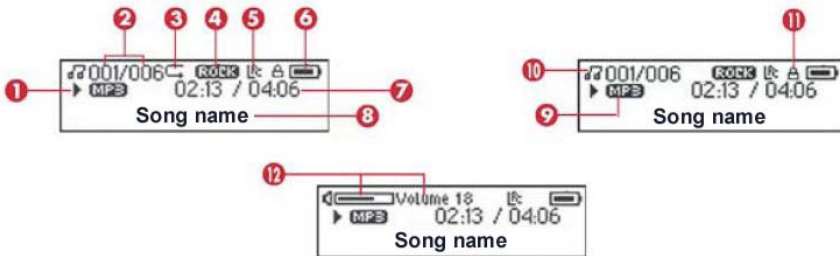

1. Play/Pause/Stop/Rec status

2. File number / Total files

3. Repeat mode

4. Equalizer mode

5. Synchronous lyric display

6. Battery indicator

7. Elapsed time / Total file time

8. ID3 Tag (track name/lyrics) display

9. Music type

10. Music mode/Voice mode

11. Hold icon

12. Volume

Transferring Music

Installing Windows Media Player

It is recommended that you install Windows Media Player to enjoy all the features of your player:
Download the appropriate version from Microsoft's website:

1. In "Select Download", choose Windows Media Player.
2. In "Select Version", select the appropriate version:
Player 10 (for Windows® XP)
Player 9 Series (for Windows® 2000)
3. Follow the instructions to finish the download.
4. Once the download is completed, double-click on the "exe" file to start the installation.

Windows Media Player 10 Overview



1. **Now Playing** Watch/listen to currently playing media.
2. **Library** Create playlists and manage your media files.
3. **Rip** Copy CD Audio tracks to WMA format.
4. **Burn** Copy MP3/WMA tracks to a recordable CD.
5. **Sync** Copy MP3 or WMA tracks to your player.
6. **Guide** Search for media (music, movies, etc.) online.

Transferring Music



Note: The instructions below apply to Windows Media Player 10. If you are using another version, please refer to the Help section on your program.

Adding Audio Files to your Media Library

Windows Media Player will automatically gather all mp3 and/or wma files on your computer into a media library, where they can be played, edited, burned to CD, or copied to your digital audio player.

1. On your computer, open Windows Media Player 10 and click on the small triangle in the upper right corner. Select Tools and then click on Search for Media Files. Alternatively, press the F3 key on your keyboard.

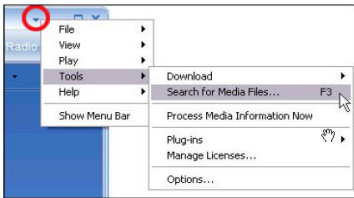

2. In the "Look in:" dialog box, browse to the drive and folder where your music files are stored.
3. Click on Search.



4. Windows Media Player will automatically add all files in the selected folder(s) to your library.
5. When searching is complete, click on *Close*.

Transferring Music

Converting CD tracks to MP3

Converting CD tracks to mp3 is often called “ripping a CD”. Use Windows Media Player to build your music library by encoding your audio CDs to music files.

1. On your computer, open Windows Media Player 10 and click on the small triangle in the upper right corner. From this menu, select *Tools* and then *Options...*

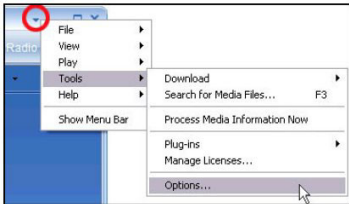

2. In the Options dialogue box, click on the *Rip Music* tab. Under Rip settings, set the Format to mp3. Under Audio quality, you can set the recording quality by dragging the slider. By default, it is set to smallest size. This quality will be sufficient for your mp3 player. You can set the quality to a higher setting, but then you can store fewer songs on your player.

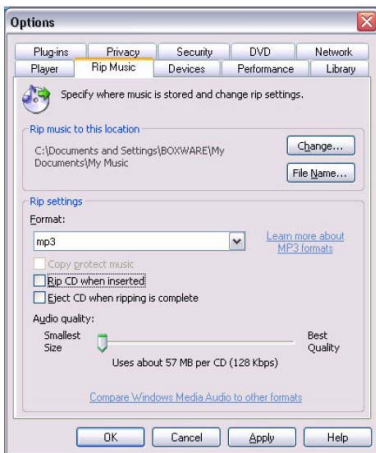

3. Click on *OK* to confirm.

Transferring Music



Note: WMP10 is now properly set up to convert audio tracks from CD to mp3 files. WMP10 can also retrieve the album, title, artist name and track names from the Internet. This kind of information, also called ID3 tag, will automatically be added if you have an active Internet connection, or you can add it manually. This information, which will be embedded in the mp3 or wma files, will be used to store the files in their own folders with clear names.

4. To start ripping your CD to mp3 audio files, insert an Audio CD into the CD or DVD drive on your computer. The following window should appear, allowing you to choose among several options:



5. Select *Rip music from CD using Windows Media Player*. WMP will automatically start ripping all audio tracks from the CD to your *My Music* folder. Inside this folder, it will automatically create a sub-folder for the artist name and a second folder with the album title.
6. In case you do not get this screen, perform the following steps to start the process:
 - Start Windows Media Player 10 and click on the *Rip* tab in the top button bar. The contents of the CD will be displayed. By default, all tracks are checked. Uncheck any track you do not want to encode into a music file.
 - Click on the *Rip Music* button to begin encoding the selected tracks.

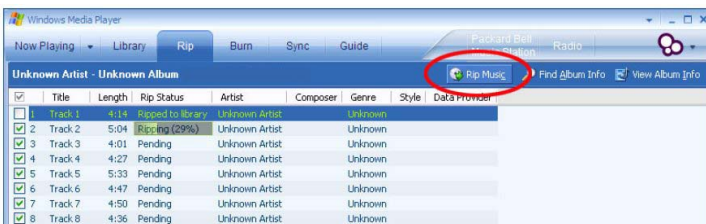

Transferring Music

7. Once all the tracks are “Ripped to library”, the CD can safely be taken out from your drive.
8. When finished, Windows Media Player will automatically add the new tracks to your library.



You can change your track encoding options by selecting **Tools > Options > Rip Music**.

Converting CD tracks to WMA

By default, Windows Media Player 10 will convert your audio tracks to WMA file format (Windows Media Audio).

WMA is very similar to MP3 and the MP3 player described here supports WMA-playback.

The process to convert an audio CD to WMA tracks is almost identical to Windows Media Player 10, except for the names used. The option “Rip Music” is called “Copy from CD”. The option to start ripping directly after inserting a CD is not available on Windows® 2000.

If you encounter problems to playback WMA files on the player, try the following setting and then transfer the WMA files to the player again.

1. Connect the player to your computer.
2. In the Windows Media Player, select *Tools* and then *Options*.
3. Select the *Device* tab.
4. Highlight this player “RCA_MPCF2488_US” in the device list and then click *Properties*.



5. Select the *Quality* tab.
6. Uncheck the option “Convert music, pictures, videos and TV shows as required by this device (recommended)”.



7. Click *Apply*.

Transferring Music

Transfer Audio Files to your Player



Caution: BEFORE YOU START:

- Make sure that your player is off and disconnect the earphones.
- Make sure the player is not locked. If the player is locked when you power it on, the screen displays "locked" and the player will automatically power off after a few seconds.
- The instructions below apply to Windows Media Player 10. If you are using another version, please refer to the Help section on your program.

1. Connect the player to one of your computer's USB ports.



2. The screen displays "USB Connected", indicating that the player is in USB mode.



3. On your computer, open Windows Media Player 10 and click on the *Sync* tab in the top button bar.
4. Click on *Edit Playlist* to add the tracks to be transferred to your player. Click on *OK* once all the desired tracks have been added.
5. You should now see the tracks you wish to transfer to your player listed and checked on the left side of the Windows Media Player screen under "Sync List". If you wish not to transfer any of the listed tracks, uncheck them.
6. Click on *Start Sync*. The selected track(s) are copied to the player.



Alternatively, use Windows Explorer to drag-and-drop audio files to the player (refer to page 22 for details).

7. After the files have been copied, unplug the player from your computer using the "Safely remove hardware" icon in the Notification Area (next to the clock). You can now listen to your music or transfer your data to another computer.



Transferring Music

Lyrics Edit

The player supports lyric files in LRC format.

1. Prepare the mp3 or wma music file you want to edit, for example "happymusic.mp3".
2. Download the corresponding lyric file from the Internet. The file must be in the LRC format, for example "happymusic-2004.lrc".

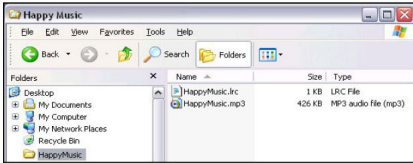

3. Rename the lyric file in its original mp3 name ("happymusic.lrc") and copy both files and lyrics to the player.

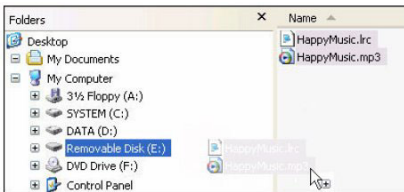

4. When lyrics are available for music files, the lyrics display synchronously on the screen while the music is playing.



Caution: Make sure the music and lyric files are saved in the same directory and under the same file name. If not, the player will not recognize the lyric file and only the ID3 tag information such as Artist, Album or Track name will be displayed.

Note: Your player only supports *.lrc files. If the lyrics do not synchronize with the music, please download another music file from the Internet and try again.

Deleting files from the player

For any files you have transferred to the player, you may delete them while you have connected the player with your computer. Highlight the unwanted file in the player's file directory on your computer and press the delete key on your computer to delete the file.

Alternatively, you may also delete the file from player, refer to the section *Navigation* on page 27 for details.

Using your Player as Mass Storage Device

Instead of using Windows Media Player, you can simply drag and drop files to the player, which appears as a removable hard drive on your computer. Using this method, any type of file (homework, presentations, pictures, etc.) can be placed on the player as if it were a portable drive. However, only mp3 and wma files will playback while stored on the player.

1. Connect the player to your computer.
2. Double-click on the My Computer icon on your Windows desktop. Windows® XP users may need to click on the Start button and select My Computer from the menu.
3. Your player has been recognized as a Mass Storage Device and automatically displays as a new device letter in the My Computer window.

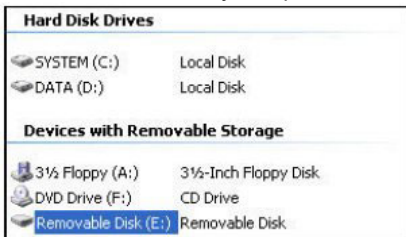

4. You can now drag and drop your files from your computer to the player. You can also copy and paste files to the player using any standard Windows method.

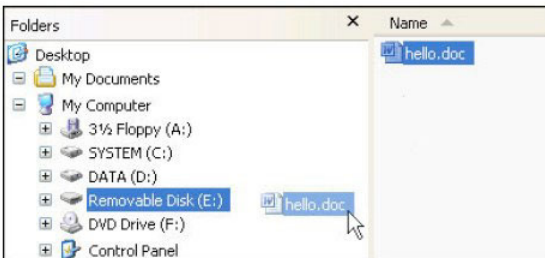

5. After the files have been copied, unplug the player from your computer (refer to page 20 for proper disconnection procedures).

Using your Player as Mass Storage Device

Performing a backup

It is recommended that you regularly backup your player's contents to a different location (on your computer, CDs, DVDs...). In that way, you will be able to use the backup copies of your files if you lose them accidentally, format your player or perform a firmware upgrade.

1. Repeat steps 1 to 3 in the previous section.
2. Drag and drop the files stored on your player to the disk or drive where you want to store the duplicate copy.
3. After the files have been copied, unplug your player from your computer.
4. If you accidentally lose or damage the files stored on your player, you will then be able to copy them back to your player.

Creating Playlist Folders

Before transferring your music files to your player you can organize them into folders and create your own playlists.

1. In *My Computer*, click on *File*. Point to *New* and click on *Folder*.



You can also create a new folder by clicking a blank area in the window, pointing to *New*, and then clicking *Folder*.

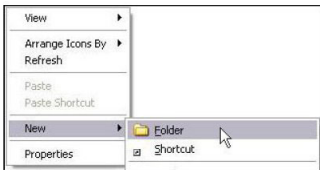

2. Type a folder name and press *Enter*.
3. Copy your music files to the folder. Repeat these steps to create folders and sub-folders.
4. After the files have been copied, unplug the player.
5. You can now use the Navigation folder to browse your music on your player.



Note: You can create up to 50 directories organized in up to 19 sub-folders, and store up to **300** music files on your player. If you create or store more files and folders, the extra items will be ignored.

You can store up to 254 files in one directory. If you store more than 254 files in one directory, you will only be able to view the first 254 in navigation mode. However, you will still be able to play the extra files in Music mode.

Playback

Listening to your mp3/wma Music Files

1. Follow the instructions for the transfer of data to and from the player to copy your music files to your player.
2. Install the supplied battery into the battery compartment and connect the supplied earphone(s) to the earphone jack.
3. Press **▶|** to power on the player and press again to start the playback.



4. Slide to **⏮** or **⏭** to skip to the previous or next file. Slide and hold during playback to fast rewind or forward a file. Slide to **⏮** within the beginning 5 seconds of the current file to skip to previous file. Otherwise, you will return to the beginning of the current file.
5. Press **■** to stop the playback.

Volume

During playback, simply slide to **+** or **-** to increase or decrease the volume. The volume indicator on the screen changes accordingly.

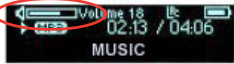

Locking your player

To ensure no button is pressed accidentally while recording or playing, you can use the Hold function to lock your player:

- To activate the hold function and lock your player, slide the Hold Switch. The hold indicator will appear on the screen.



- To unlock it, simply slide it backwards.



Note: If the player is locked when you power it on, the screen displays "Locked" and the player will automatically power off after a few seconds.

Playback

Synchronizing Lyrics Display

The player supports lyric files in LRC format. Refer to page 21 for more information.

When lyrics are available for music files, the LRC icon displays and the lyrics display synchronously on the screen while the music is playing.







Note: Make sure the music and lyric files are saved in the same directory and under the same file name. If not, the player will not recognize the lyric file and only the ID3 tag information such as Artist, Album or Track name will be displayed.

File Browsing

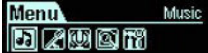
- To enter the Menu, press **M**.
- To browse the menu items, slide to **◀** or **▶**.
- To enter a menu or apply a choice, press **▶**.
- Press and hold **M** briefly and release it to return to the normal playback screen.

Menu Structure

Menu	Screen display	For details:
Music		page 24
Record		page 28
Voice		page 30
Navigation		page 27
Settings		page 31-33

Navigation

The navigation menu allows you to browse and manage the folders and files stored in your player.

1. Press **M** and select Navigation from the Menu.
2. Slide to **◀** or **▶** to select a file or folder and press **▶** to play the music or enter the folder.
3. In navigation mode, press **◀** to go back to the previous screen.



1. Return to the previous level
2. Selected folder
3. Music files
4. More files for selection
5. Selected folder name

When a folder is selected in navigation mode, press **M**. A sub-menu will show:

- To enter the folder, select *Enter*.

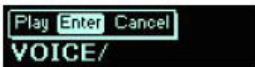

- To play the music stored in the folder, select *Play*.



- To erase the selected file, select *Delete*. Slide to **◀** or **▶** to select between *Yes* and *No* and press **▶** to confirm.



File Browsing



Warning: Erased files cannot be recovered. Make sure you have a backup before you proceed.

Note: You can create up to 50 directories organized in up to 19 sub-folders, and store up to **300** music files on your player. If you create or store more files and folders, the extra items will be ignored.

You can store up to 254 files in one directory. If you store more than 254 files in one directory, you will only be able to view the first 254 in navigation mode. However, you will still be able to play the extra files in Music mode.

Recording

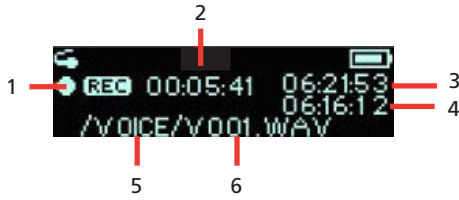

1. Recording status
2. Elapsed time
3. Total time
4. Remaining time
5. Folder name
6. File name

Recording from the Built-in Microphone

The player allows you to record from the built-in microphone. Note the location of the built-in microphone.

1. Press **M** and select *Record* from the Menu.



2. Slide to **◀** or **▶** to highlight Yes and press **▶** to confirm. The recording starts automatically.



3. Press **■** or **M** to stop recording and enter the voice mode. Your voice recording will be automatically renamed as a Vxxx.wav file and stored in the Voice folder.

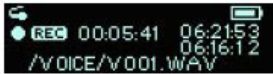

Note: The display will show "MEMORY FULL" when all available memory has been used.

Adjusting Recording Settings

This option allows you to adjust the settings for the recordings.

1. Select *Record* from the settings menu and press **M**.



2. Select the file format of your recording.



Note: The recording formats are only slightly different. It is not recommended to change this setting.

Recording

3. Select the sampling frequency of your recording. A higher recording sampling frequency brings better recording quality but will use more storage space.



Sampling Frequency	Maximum recording time	Maximum recording time
8000 Hz	TH1401	TH1402
11025 Hz	64 hours	128 hours
16000 Hz	46.4 hours	92.8 hours
22050 Hz	32 hours	64 hours
32000 Hz	23.2 hours	46.4 hours
	16 hours	32 hours

Playback of Microphone Recordings

1. Select *Navigation* from the menu and browse for the *VOICE* folder. Press ►| to enter.



2. Slide to ◀◀ or ▶▶ to find the Vxxx.WAV file you want to listen to.
3. Press ►| to play the recording.

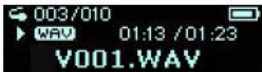

Settings

Adjust Settings

To navigate in the Settings menu:

1. Press **M** to enter the menu.
2. Select settings from the menu and press ►|.



3. Slide to ◀◀ or ▶▶ to select the setting you wish to adjust and press ►| to confirm.
4. Press and hold **M** briefly and release it to return to the normal playback screen.

Equalizer

The Equalizer (EQ) setting is used to adjust the music playback effect.

1. To change the equalizer setting, select *Equalizer* from the settings menu. To navigate, follow the steps described above.



2. Slide to ◀◀ or ▶▶ to choose among the six EQ presets available: Normal (no logo displayed), XBass, Rock, Jazz, Classical and Pop.



3. Press ►| to apply.

Repeat Mode

Five repeat modes are available: Normal, Repeat One, Repeat All, Random, Random All.

1. Select *Repeat* from the settings menu. To navigate, follow the steps described above.



2. Slide to ◀◀ or ▶▶ to select one of the repeat modes and press ►| to apply.



- Random and Random All modes are available for music playback only.

Settings

Contrast

To adjust the display contrast:

1. Select *Contrast* from the settings menu. To navigate, follow the steps described above.



2. Slide to ◀ or ▶ to adjust the level. Press ▶ to apply and return to the settings menu.



Backlight - Timer Adjustment

After being idle for a few seconds, the device can automatically turn off the backlight to save power. To wake the backlight up, just press any button.

1. Select *Backlight* from the settings menu. To navigate, follow the steps described on page 31.



2. Select *Timer* from the Backlight menu.



3. Slide to ◀ or ▶ to adjust the delay before backlight is switched off. Choose among the options: 3, 5, 10, 15 seconds and Always on (backlight will always be turned on).
4. Press ▶ to apply.

Power Savings

You can use the power savings function to automatically turn off the player after a predetermined period of inactivity.

1. Select *PowerSavings* from the settings menu. To navigate, follow the steps on page 31.



2. Slide to ◀ or ▶ to select amongst the options (Off, 1, 2, 5, 10, 15 minutes) and press ▶ to apply.



Note: If you choose "Off", the player will not power off until the battery is completely exhausted.

Settings

Default Settings

You can reset all settings to factory default settings.

1. Select *Default* from the settings menu. To navigate, follow the steps described on page 31.



2. Press ► or M to load the default settings to your player.

Language

You can display the interface of your player in several languages.

1. Select *Language* from the settings menu. To navigate, follow the steps described on page 31.



2. Slide to ◀ or ▶ to select among the options: English (default), Français (French), Español (Spanish), Deutsch (German), Italiano (Italian) and Nederlands (Dutch) and press ► to apply.



Information About your Player

Information is available regarding the firmware version, built-in memory size and free memory size.

1. Select *About* from the settings menu. To navigate, follow the steps described on page 31.
2. The firmware version and the total memory capacity display. Slide to ◀ or ▶ to view the free memory space
3. Press M to exit this screen and return to the settings menu.



Note: To learn more information on your player, check out the Specifications section in this user manual.

Advanced Features

Upgrading your Player (Firmware update)

Should you encounter problems with your player, you may be able to repair it yourself by updating its firmware. Firmware updates can fix bugs in the player and improve its performance. You should regularly check the RCA Website www.rcaaudiovideo.com for the latest Firmware updates available. Downloading the upgrade and installing it on your player is easy and will only take a few minutes.



Note: The 'firmware' is an embedded program that displays the interface and responds to instructions. Firmware updates may be available to improve performance or add features.

You can download the firmware from <http://www.rcaaudiovideo.com/downloads>.

For best performance, we recommend that you select the Format Data Area option to format both the firmware and the storage space. When not selected, only the firmware will be updated. When finished, please format the player.

If you upgrade your firmware, some of the instructions in the supplied documentation may no longer be applicable.

Warning: Formatting will erase all files on your player. Make sure you have a backup before you proceed.

Advanced Features

Formatting the Player

1. Connect the player to the computer.
2. Right-click on the player icon in My Computer and select Format.

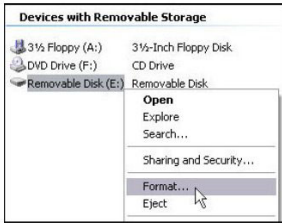

3. Click on Start in the format window, and then click on OK to start formatting the mp3 flash memory.



Warning: Formatting will erase all files on your player. Make sure you have a backup before you proceed.

Make sure "NTFS" under File System drop-down menu is not selected! If you select this option the "RCA player" will display an error message before powering off and you will have to format it again. Check out the Troubleshooting section for more details.

Additional Information

Troubleshooting

- The display shows nothing after turning on the player.
 - Check to see if the battery has been inserted.
 - Check to see if the battery needs replacement: Try reinserting the battery correctly or replace it. If it still does not work, put the player in recovery mode:
 1. Take out the battery from the battery compartment.
 2. Press and hold ►||. Do not release it until step 4.
 3. Plug the player into the USB port of your computer.
 4. Hold for 5 seconds and release ►|| once the computer has detected the player.
 5. Leave the player in the USB port for the next step (Upgrading the Firmware + Formatting the player).



Note: If the Firmware Upgrade utility does not recognise your player after searching for several minutes, click on Cancel and repeat steps 1 to 5 to make sure the player is in recovery mode.

- The player displays an error message before powering off.

Incorrect format
Reformat the player!

- If you have formatted your player to NTFS format, the above message will display and your player will power off automatically. You must reformat it to FAT or FAT32 format.
- Why can't I play files in the player?
 - WMA files may be DRM protected and you do not have the proper rights (license) to play the files.
 - Check the website and/or application help system of the music download service provider from where the content was purchased for license acquisition details. For more information on how license acquisition works, go to www.microsoft.com/windowsmedia/drm
- Problem: Cannot delete files on the player.
 - Refer to page 27 (Navigation) for details.
- Why can't I play subscribed secure music files that are downloaded from internet?
 - Subscribed secure music files are not supported in this player.
- Why can't I play WMA files in the player?
 - You may need to refine your settings in the Windows Media Player, please refer to page 19 for details.

Additional Information

Specifications

Hardware

- Dimensions: 82mm H, 27 mm W, 20 mm D / 3.3 (H), 1.1 (W), 0.8 (D) inches
- Unit Weight: 24 g / 0.85 oz
- Battery Operated: 1 x AAA battery.

Flash

- TH1401: 1024MB (6 MB reserved for firmware and system management)

Power

- 1 x AAA battery
- Battery continuous playing time: up to 15 hours

Equalizer

- Normal, XBass, Rock, Jazz, Classical, Pop

Display

- 128 x 32 Dot-matrix OLED
- ID3 Tag display (album, artist, title)
- Synchronous lyric display

Controls

- Power On / Play / Pause / Select
- Stop / Power Off
- Skip Next / Fast Forward
- Skip Previous / Fast Rewind
- Menu button
- Volume +
- Volume –
- Hold Switch

Audio Playback

- Windows Media Audio (WMA)
- MPEG Audio Layer 3 (MP3)
- WAV

Voice Recording

- 8 KHz to 32 KHz sampling rate
- about 64 hours recording (at default setting, i.e. 8 KHz)
- Recording via on-board microphone

Additional Information

Signal to Noise Ratio

- >85 dB, A-weighted

Frequency Response

- 20 Hz ~ 20 kHz

Total Harmonic Distortion Output

- => THD (<0.1%)

Check for updates

Visit <http://www.rcaaudiovideo.com> for the latest news and firmware upgrades for our digital media player.

Additional Information

Limited warranty (US)

What your warranty covers:

- Defects in materials or workmanship.

For how long after your purchase:

- One year from date of purchase.
The warranty period for rental units begins with the first rental or 45 days from date of shipment to the rental firm, whichever comes first.

What we will do:

- Provide you with a new, or at our option, a refurbished unit. The exchange unit is under warranty for the remainder of the original product's warranty period.
- Proof of purchase in the form of a bill of sale or receipted invoice which is evidence that the product is within the warranty period must be presented to obtain warranty service. For rental firms, proof of first rental is also required.

How to make a warranty claim:

- Properly pack your unit. Include any cables, etc., which were originally provided with the product. We recommend using the original carton and packing materials.
- Include evidence of purchase date such as the bill of sale. Also print your name and address and a description of the defect. Send via standard UPS or its equivalent to:

Thomson Inc.
Product Exchange Center
11721 B Alameda Avenue
Socorro, Texas 79927

- Insure your shipment for loss or damage. Thomson accepts no liability in case of damage or loss en route to Thomson.
- Pay any charges billed to you by the Exchange Center for service not covered by the warranty.
- A new or refurbished unit will be shipped to you freight prepaid.

What your warranty does not cover:

- Customer instruction. (Your Owner's Manual provides information regarding operating Instructions and user controls. For additional information, ask your dealer.)
- Installation and set-up service adjustments.
- Batteries.
- Damage from misuse or neglect.
- Products which have been modified or incorporated into other products.

- Products purchased or serviced outside the USA.
- Acts of nature, such as but not limited to lightning damage.

Product Registration:

- Please complete and mail the Product registration Card packed with your unit. It will make it easier to contact you should it ever be necessary. The return of the card is not required for warranty coverage.

Limitation of Warranty:

- THE WARRANTY STATED ABOVE IS THE ONLY WARRANTY APPLICABLE TO THIS PRODUCT. ALL OTHER WARRANTIES, EXPRESS OR IMPLIED (INCLUDING ALL IMPLIED WARRANTIES OF MERCHANTABILITY OR FITNESS FOR A PARTICULAR PURPOSE) ARE HEREBY DISCLAIMED. NO VERBAL OR WRITTEN INFORMATION GIVEN BY THOMSON INC., ITS AGENTS OR EMPLOYEES SHALL CREATE A WARRANTY OR IN ANY WAY INCREASE THE SCOPE OF THIS WARRANTY.
- REPAIR OR REPLACEMENT AS PROVIDED UNDER THIS WARRANTY IS THE EXCLUSIVE REMEDY OF THE CONSUMER. THOMSON INC. SHALL NOT BE LIABLE FOR INCIDENTAL OR CONSEQUENTIAL DAMAGES RESULTING FROM THE USE OF THIS PRODUCT OR ARISING OUT OF ANY BREACH OF ANY EXPRESS OR IMPLIED WARRANTY ON THIS PRODUCT. THIS DISCLAIMER OF WARRANTIES AND LIMITED WARRANTY ARE GOVERNED BY THE LAWS OF THE STATE OF INDIANA. EXCEPT TO THE EXTENT PROHIBITED BY APPLICABLE LAW, ANY IMPLIED WARRANTY OF MERCHANTABILITY OR FITNESS FOR A PARTICULAR PURPOSE ON THIS PRODUCT IS LIMITED TO THE APPLICABLE WARRANTY PERIOD SET FORTH ABOVE.

How state law relates to this warranty:

- Some states do not allow the exclusion nor limitation of incidental or consequential damages, or limitations on how long an implied warranty lasts, so the above limitations or exclusions may not apply to you.
- This warranty gives you specific legal rights, and you also may have other rights that vary from state to state.

If you purchased your product outside the USA:

- This warranty does not apply. Contact your dealer for warranty information.

Thomson Inc.
P.O. Box 1976
Indianapolis, IN 46206-1976
© 2007 Thomson Inc.
Trademark(s) ® Registered
Marca(s) ® Registrada(s)
Marque(s) ® Déposée(s)
www.rcaudiovideo.com

v2.0

40