



# QuickStartGuide



TH17 series

www.rcaaudiovideo.com

## Congratulations on purchasing your new RCA Player.

Please read these instructions for quick tips on using the player.

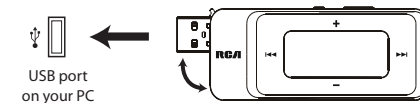
## Getting started

1. Install the battery into the player:
  - Apply thumb pressure to slide the battery compartment cover in the direction of the arrow, then remove the cover.
  - Insert the supplied AAA battery, following the polarity marks in the battery compartment.
  - Replace the cover.
2. Rotate the USB plug out of the player body and connect the player to your PC as shown.
 
3. The RCA easyRip™ Media Software installer (stored in the player\*) will launch automatically. Click **NEXT** to begin the installation and follow the instructions to install the software on your PC.
  - RCA easyRip is currently not compatible with DRM files and Audiobooks.
  - If the installer does not auto-launch, go to **MyComputer** in the Start menu, find and open the drive letter associated with the player (i.e. PEARL) and then double-click the **rcaeasyrip\_setup** file to launch the installer.
4. Transfer audio files to your player using either of the two methods below:
  - a) **RCA easyRip:** Helps to rip CD's, create playlists, load content and manage your library with an intuitive and modular design. Click the easyRip icon (  ) on your PC desktop to launch the software.
  - For details in using RCA easyRip, click the **Help** icon (  ) on the module dock.

v2.0 (EN/E)

- b) **Windows Explorer:** Simply drag and drop media files onto the drive letter associated with the player.
  - Your RCA Player is also compatible with most PC music management softwares.

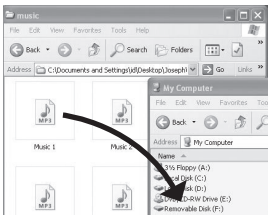

5. Disconnect the player from your PC by clicking the **Safely Remove Hardware** icon (  ) in the system tray (located in the lower right corner of your screen) and selecting the player from the list of devices, then unplug the player from the PC.

## Installing the belt clip

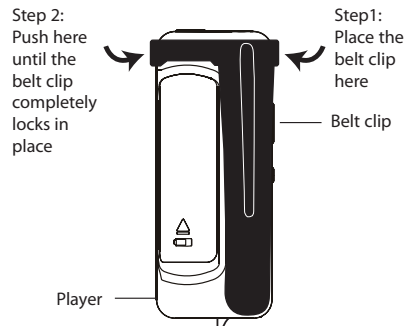

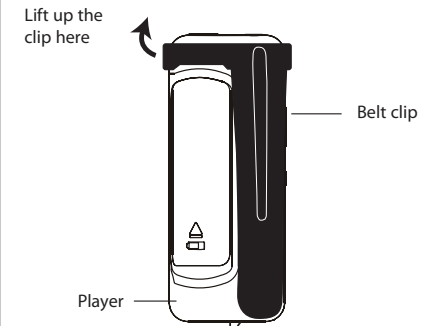

\* The latest software can be downloaded from [www.rcaaudiovideo.com](http://www.rcaaudiovideo.com).  
Windows is a registered trademark of Microsoft Corporation in the United States and other countries.

## Removing the belt clip



## Learn more about the player

- **To view the user manual directly from the player:**
  - Step 1: Click **Start**.
  - Step 2: Click **My Computer** (XP users) / Click **Computer** (Vista users).
  - Step 3: Right-click the associated drive letter (i.e. PEARL) to show the option menu.
  - Step 4: From the option menu, select the user manual in your preferred language for more information on the player's features, safety and warranty information, and answers to Frequently Asked Questions (FAQ's).
- **To view the user manual on your PC:**

If opted-in during installation, the user manual will also be available by clicking on the Start menu (  in XP or  in Vista ), clicking on All Programs, clicking on the RCA directory, and then clicking on the appropriate manual.
- **Keep player out of direct sunlight. Exposure to direct sunlight or extreme heat (such as inside a parked car) may cause damage or malfunction.**

## Need more help? Do not return this product to the store.

Visit [www.rcaaudiovideo.com](http://www.rcaaudiovideo.com) for the latest firmware, RCA easyRip Media Software, user manual and FAQ's.

## General controls

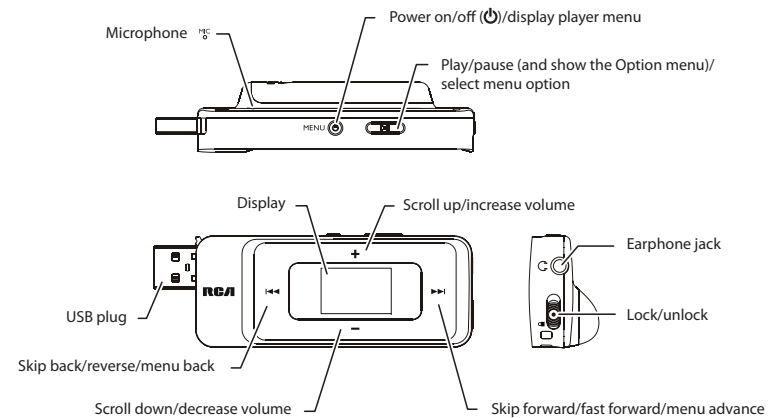



Turn the player on/off

Navigate to an audio file

Press and hold **MENU**.

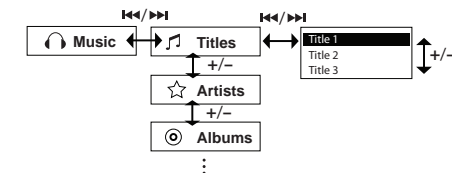
In the Home menu, press **⏪** or **⏩** to go back or advance in the player menu and press **+** or **-** to scroll up or down to the desired file



Play an audio file	Press <b>▶▶</b> or <b>▶▶▶</b>
Pause playback and show the Option menu	Press <b>⏸</b> at the playback (Now playing) screen, press again to resume
Adjust the volume	Press <b>+</b> or <b>-</b> at the playback (Now playing) screen
Skip to the next file (or section of audiobooks*)	Press <b>▶▶▶</b>
Skip to the previous file (or section of audiobooks*)	Press <b>⏪⏪</b> within the first 4 seconds of the current audio file
Reverse or fast forward an audio file	Press and hold <b>⏪⏪</b> or <b>▶▶▶</b> during playback
Go to the Home menu (to access Music, Audiobooks, Radio, Voice Memo, Favorites and Settings)	Press <b>MENU</b>
Lock the keys	Slide "Lock/unlock" towards the (  ) icon
Delete files from the player	Refer to page 14-18 of the user manual
Reset the player	Remove and replace the battery

\* Refer to the user manual for information on section skipping for audiobooks.

For information on new and upcoming products and to register your new player, visit [www.rcaaudiovideo.com](http://www.rcaaudiovideo.com).

Audiovox Electronics Corp.,  
150 Marcus Blvd., Hauppauge, NY 11788  
© 2009 Audiovox Electronics Corp.  
Trademark Registered  
[www.rcaaudiovideo.com](http://www.rcaaudiovideo.com)  
Printed in China

