

VOD85
8.5" OVERHEAD LCD
MONITOR WITH
DVD PLAYER

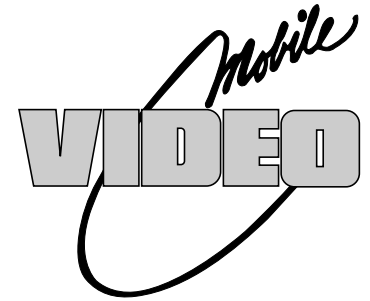

**OPERATION
MANUAL**

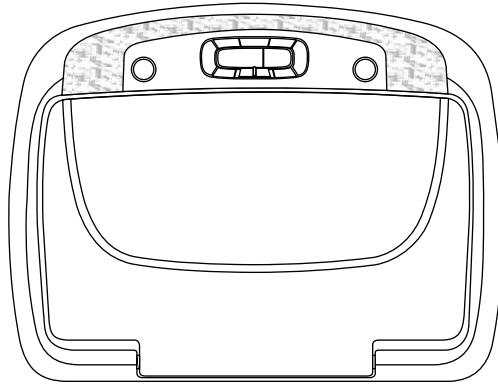

128-7636

Important Notice

An LCD panel and/or video monitor may be installed in a motor vehicle and visible to the driver if the LCD panel or video monitor is used for vehicle information, system control, rear or side observation or navigation. If the LCD panel or video monitor is used for television reception, video or DVD play, the LCD panel or video monitor must be installed so that these features will only function when the vehicle is in “park” or when the vehicle’s parking brake is applied.

An LCD panel or video monitor used for television reception, video or DVD play that operates when the vehicle is in gear or when the parking brake is not applied must be installed to the rear of the driver’s seat where it will not be visible, directly or indirectly, to the operator of the motor vehicle.

Warnings

- Do not use any solvents or cleaning materials when cleaning the video monitor.
- Do not use any abrasive cleaners, they may scratch the screen.
- Use only a lightly dampened lint free cloth to wipe the screen if it is dirty.
- Lock the LCD screen in the fully closed position when not in use.
- Before putting on headphones always adjust the volume setting to the lowest position.
- Remember to leave the dome light switch in the off or auto positions when the vehicle is unattended, as the dome lights, if left on, can drain the vehicle’s battery.
- Do not put pressure on the screen.
- Caution children to avoid touching or scratching the screen, as it may become dirty or damaged.

Television Reception

This entertainment system is designed primarily for viewing prerecorded movies or playing video games. If this system has the optional TV Tuner (PODVT2) installed: Television reception in a moving vehicle will be limited and in some areas will not be possible due to weak and variable signal strength. Television viewing in a stationary vehicle will result in an improvement, but may still be marginal due to signal strength. The quality of the picture will not be consistent with home TV reception. Reception may be affected by weather and distance from TV station. A weak signal may cause the picture to roll, be snowy, or cause some color loss.

Licensed under one or more of the following patents,
Patent NOS. 5,775,762 and 5,927,784

Congratulations on your purchase of the AUDIOVOX VOD85 DVD Player with Drop-Down Video / Monitor. The VOD85 has been designed to give you and your family many years of video entertainment in the mobile environment. Please read the directions that follow to familiarize yourself with the product to ensure that you obtain the best results from your equipment.

Please note: Installation options vary, see the individual owner's manuals for each component in your system to obtain a full understanding of each component's operation.

Safety Precaution

For safety reasons, when changing video media it is recommended that the vehicle is not in motion, and that you do not allow children to unfasten seat-belts to change video media or make any adjustments to the system. System adjustments can be accomplished using the remote control, while seat-belts remain fastened. Enjoy your AUDIOVOX entertainment system but remember the safety of all passengers remains the number one priority.

FEATURES

- 8.5" TFT (Thin Film Transistor) Active Matrix LCD (Liquid Crystal Display) Monitor
- Built-in DVD Player
- * Auto On with Disc insertion
- Selectable (M1 and M2) IR Receive and Transmit Codes
- Multi-Lingual OSD (On Screen Display) for Control of Picture Quality and Functions
- Switchable Channel Infrared Transmitter for use with IR Wireless Headphones
- Four Audio / Video Source Inputs (DVD, AUX/Game, AV1, AV2/TV*)
- Dome Lights with Built-in Three Way Switch
- Built-in Five Frequency Wireless FM Modulator
- Last Position Memory for DVD
- Headphone Jack
- Screen Mode Selection (16:9, 4:3)
- Wireless Game Controller
- Full Function Remote Control
- Backlit Controls
- Day / Night Picture Modes
- AV Output
- * Optional TV tuner (P/N PODTVT2)

CONTROLS AND INDICATORS DIAGRAM (FRONT VIEW)

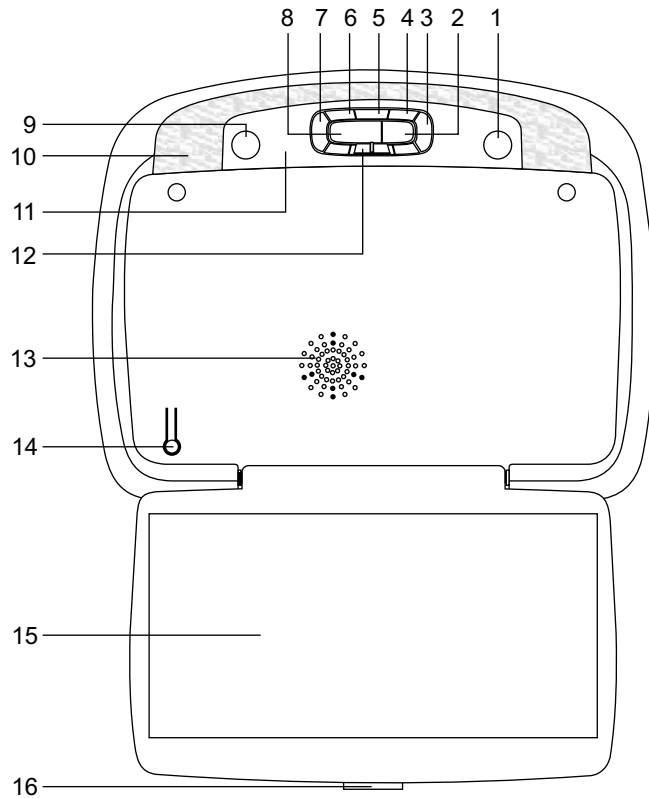

1. EJECT (▲) Button

This Button is used for ejecting discs from the disc Compartment. (**Note:** Disc can be ejected with the unit turned Off. Vehicle has to running or in ACC position). After the Disc is removed the unit will turn Off after 15-20 seconds.

2. STOP (■) Button

This button is used to stop playback.

3. Source Select

Use to select one of the four sources: DVD, AV1, AUX / GAME, AV2 / *TV (Optional).

4. Volume (+)

To increase the volume of wired headphones and increase the level of selected picture controls.

5. Picture Select Button

Allows the user to enter the picture adjustment mode.

6. Volume (-)

To decrease the volume of wired headphones and decrease the level of selected picture controls.

7. FMM Source Select Switch

Used to select the frequency in sequence rotation: FM OFF, 88.3MHz, 88.7MHz, 89.1MHz, 89.5MHz or 89.9MHz.

8. PLAY (▶) Button

This button is used to start playback of a disc.

CONTROL FUNCTION DESCRIPTION (FRONT VIEW)

9. POWER (Ⓜ) Button

Used to turn the system on/off. Bright red when the system is on, dim when off.

10. Dome Lights

Provide additional interior illumination.

11. Infrared Transmitter and Sensor

Use to transmit audio the wireless headphone. Also allows the remote control to operate the VOD85 and to control other accessories in the system.

12. Three Position Dome Light Switch

ON – Turns on the dome lights.

OFF – The dome lights will not turn on in this position.

AUTO – Automatically switches on the dome lights in conjunction with the vehicle's interior illumination.

13. Ventilation Openings

14. LCD Cut Off Switch

Used to turn off the LCD panel monitor when in the closed position.

15. LCD Panel

16. Screen Release

Press to release the screen.

The VOD85 has an option that allows the user to select from two IR transmit and receive codes (M1 or M2). This feature can be used when using two VOD85s in the same installation or if the vehicle has an RSA (Rear Seat Audio) that uses an "A" channel headset. The VOD85 comes factory set to M1. When in the M1 mode the unit will respond to remote commands when M1 is selected on the remote and will transmit audio on the A channel. When in the M2 mode the unit will respond to remote commands when M2 is selected on the remote and will transmit audio on the B channel.

Note: 2-channel IR headphones will need to be used when monitor is set to M2 mode.

Note:

OSD will appear on the screen for 4~5 seconds

Selecting a Monitor Code (M1 or M2)

1. Press and hold the **SOURCE** and **FMM** buttons on the unit for 3 seconds and the unit will switch from M1 to M2 or M2 to M1.
2. The selected mode (M1 or M2) will be retained in memory until changed by the user.

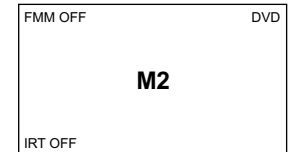
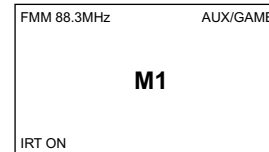

CONTROL FUNCTION DESCRIPTION (SIDE VIEW & BACK VIEW)

Side View

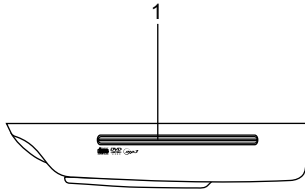

1. DVD Disc insertion Slot

For loading and removing discs. Unit will turn On and load disc when disc is inserted.

Note: Disc slot will be lit when unit is turned Off for easy loading at night.

Back View

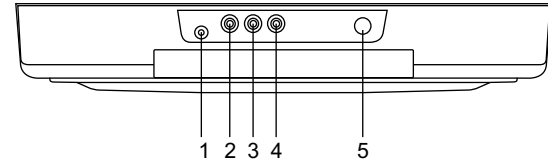

1. Headphone Jack

Allow the use of wired headphones with a 1/8" (3.5mm) plug for listening to the video program audio.

2. Auxiliary Video Input

3. Auxiliary Audio Left Input

4. Auxiliary Audio Right Input

5. PAUSE (||) Button

Allows the front seat passenger to pause the playback. Pressing PAUSE again or pressing the PLAY button will resume normal playback.

REMOTE CONTROL OPERATION

Back View

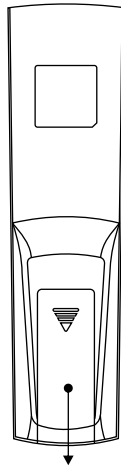

Battery Cover

Battery Installation

Before attempting to operate your Remote Control, install the batteries as described below.

- 1) Turn the Remote Control face down. Using your finger, slide the battery cover off in the direction of the arrow.
- 2) Install Two "AAA" batteries. Make sure that proper polarity (+ or -) is observed.
- 3) Align the cover tabs with the remote control and slide the cover until it locks.

The remote control will operate the VOD85. It is not a universal remote control and will not control equipment from other manufacturers.

MAIN FUNCTION DESCRIPTION

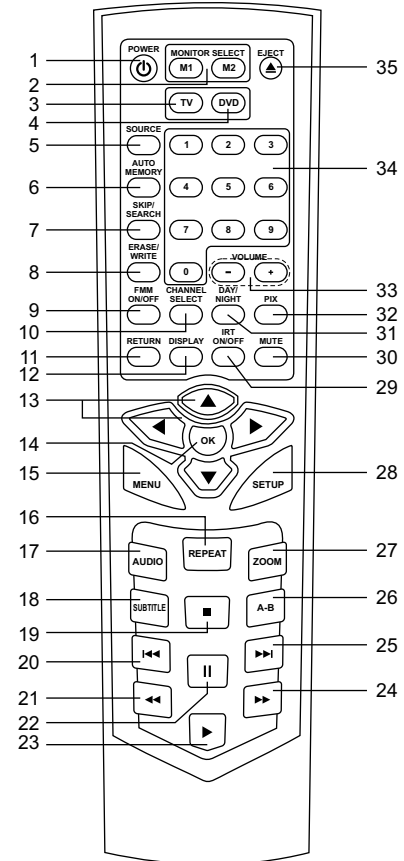

* Function control is available on the unit and the remote control.

** The TV Option will only be displayed and the TV control functions are only available if the optional TV Tuner (P/N PODTVT2) is installed.

1. POWER Button*

Press this button to turn the VOD85 ON and OFF.

2. MONITOR SELECT

M1 Button – Change the remote control code to enable to control of the VOD85 when set to the M1 mode.

M2 Button – Change the remote control code to enable to control of the VOD85 when set to the M2 mode.

3. TV Mode Select Button**

Switches certain function keys on the remote control for TV functions.

4. DVD Mode Select Button

Switches certain function keys on the remote control for DVD functions.

5. SOURCE Button*

Each time the button is pressed, the audio / video source will change in the following sequence: DVD > AUX/GAME > AV1 > AV2/TV**.

6. AUTO MEMORY Button (AUTO PROGRAM Button)**

When the AUTO MEMORY button is pressed, all channels are searched and channels that are detected with signals of sufficient levels are automatically stored in memory.

7. SKIP / SEARCH Button**

This button selects between SKIP and SEARCH mode. In "SKIP mode" the TV tuner will tune and stop on channels that are programmed into memory when the CHANNEL UP / DOWN buttons are used. When the SKIP mode is disable, the TV will stop on all active channels.

8. ERASE / WRITE Button**

While tuned to a channel, pressing this button will alternately store or erase the channel from memory.

9. FMM ON / OFF Button*

Turns the wireless FM Modulator on or off.

10. CHANNEL SELECT Button*

Selects the wireless FM Modulator Frequency (Frequency 1: 88.3MHz, Frequency 2: 88.7MHz, Frequency 3: 89.1MHz, Frequency 4: 89.5MHz, Frequency 5: 89.9MHz)

11. RETURN Button

Not used on this model.

12. DISPLAY Button

Press to display the current disc information while the disc is playing. Press the cursor (▲▼◀▶) buttons to highlight the desired option. For title and chapter selection use the number buttons to enter the desired title or chapter number. For angle, audio, and subtitle, press the ENTER button repeatedly to change the selected item.

Title
Chapter
Angle
Audio
Subtitle

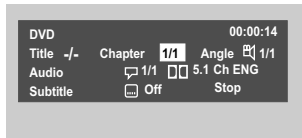

13. CURSOR / CHANNEL UP DOWN (▲▼◀▶) **

Use these buttons to navigate the menu selections on the screen.

Use the CH▲ to increase the channel number and use CH▼ to decrease the channel number. **

14. OK Button (ENTER)

Used to implement a selected setting or menu option.

15. MENU Button

Allows the user to access the DVD (DVD MODE) root menu and system menu (TV mode).

16. REPEAT Button

Allows the user to repeat a selected title, chapter, or track.

17. AUDIO Button

Press to display and select the available AUDIO languages in DVD mode. Each time you press the button, the language changes.

Note: *The languages for audio vary from disc to disc.*

18. SUBTITLE Button

Press to display and select the available subtitle language in DVD mode. Each time you press the button, the subtitle language changes.

Note: *The type and number of languages for subtitle vary from disc to disc.*

19. STOP (■) Button*

Press to stop playback.

20. PREVIOUS (⏮) Button

Press to return to the previous chapter or track.

21. SCAN BACKWARD (⏪) Button

Press to search in a backward direction. Press repeatedly to change the search speed from 2, 4, 8, and 20 times the normal speed.

22. PAUSE (⏸) Button*

Allows the user to pause the playback.

Pressing pause again or pressing the Play Button will resume normal playback.

23. PLAY Button*

Press to activate the play mode when a disc is loaded in the disc compartment.

24. SCAN FORWARD (⏩) Button

Press to search in a forward direction. Press repeatedly to change the search speed from 2, 4, 8, and 20 times the normal speed.

25. NEXT (») Button

Press to skip to the next chapter or track.

26. A-B Button

Allow user to repeat the playback from point A to point B.

<u>Press A-B button</u>	<u>On-Screen Display</u>	<u>DVD player</u>
Once	Repeat A-	Mark the beginning of the section to repeat (Set point A)
Twice	Repeat AB	Mark the end of the section to repeat (Set point B)
3 times	AB Off	Cancel the A-B repeat function

27. ZOOM Button

Press this button to enlarge the picture when playing a DVD disc.

<u>Press ZOOM button</u>	<u>DVD player perform</u>
Once	Enlarge the picture 2 times of the original size
Twice	Enlarge the picture 3 times of the original size
3 times	Enlarge the picture 4 times of the original size
4 times	Picture is returned to original size

28. SETUP Button

Press to display the Setup Menu which allows the user to change the DVD player options such as TV DISPLAY, OSD LANGUAGE, PARENTAL CONTROL etc.

Refer to the settings and Adjustments section for more information.

29. IRT ON/OFF Button

Turns the Infrared Transmitter IRT ON or OFF for IR Wireless Headphones. Pressing M1 then IRT ON/OFF will control the IR Transmitter for M1. Pressing M2 then IRT ON/OFF will control the IR Transmitter for M2.

30. MUTE Button

Press this button to mute the audio for wireless FMM and wired headphone.

Pressing the button again restores the sound to the previously set level.

31. DAY / NIGHT Mode Button

This control toggles the unit between “Day” and “Night” LCD illumination modes. In the “Day” mode, the LCD backlit intensity is at maximum. In “Night” mode, the LCD backlit is dimmed to a preset level that is more suitable for low light operation.

32. PIX Button (Picture Select)*

Each time this button is pressed, the on screen picture adjustment displays the “adjustment bar” for BRIGHTNESS, CONTRAST, COLOR, TINT or RESET. Once the desired adjustment bar is displayed, use the VOLUME(+)/ VOLUME(–) button to adjust the setting. The display will automatically turn off if no adjustments are made within 6 seconds, or if any other button is pressed.

33. VOLUME DOWN (–) or UP (+)*

Press to decrease or increase the volume level of the wired headphone jack. It is also used to make picture adjustments in the picture select mode.

Note: *The volume control will not affect the volume of wireless headphones or the FM modulator. When using these devices, the volume must be adjusted with the wireless headphone volume control or with your radio’s volume control.*

34. NUMBER Buttons

Allow the user to enter numbers 0 to 9 for selection of selection of CD tracks, DVD chapters, password setting and direct access of TV channels if the optional TV tuner (P/N PODTVT2) is installed.

35. EJECT (▲) Button*

This button is used to eject the disc.

SETTINGS AND ADJUSTMENTS

PICTURE ADJUSTMENTS

When watching a program, the picture quality can be adjusted to suit your taste.

PIX (P) Button

- 1) Each time this button is pressed, the on screen picture adjustment displays the “adjustment bar” for BRIGHTNESS, CONTRAST, COLOR, TINT or RESET.
- 2) Once the desired adjustment bar is displayed, use the VOLUME(+)/ VOLUME(-) button to adjust the setting.
The display will automatically turn off if no adjustments are made within 6 seconds, or is any other button is pressed.



- 3) Press the PIX button five times to select **RESET**, then press either Volume (-) or the Volume (+) button on the remote or the main unit and all of the picture settings (BRIGHTNESS, CONTRAST, COLOR and TINT) will return to the factory setting.



VOLUME

Use the Volume (-) or Volume (+) button on the unit or the remote control to decrease or increase the volume level of the wired headphones.

MENU ADJUSTMENT

SYSTEM (MAIN) MENU and On Screen Display (OSD)

- 1) In TV mode, Press the MENU button on the remote, the main page of the system menu will appear on screen.
- 2) Use the cursor buttons ▲ or ▼ to select the desired item in the main page and press the OK button to select.
- 3) The sub menu will appear on screen.
- 4) Use the cursor buttons ▲ or ▼ to select an item in the sub menu and then press the OK button to select.
- 5) Press the Menu button to exit System Menu.

Note: System Menu can be control via Remote Control only.
(Items selected in the menu will have a green background)

SCREEN MODE SELECT

This allows the user to change the screen format (aspect ratio 16:9, 4:3).

- 1) To select the screen aspect ratio format highlight SCREEN MODE and then press the OK button to enter the sub menu. Then use the cursor buttons ▲ or ▼ to select from either 4:3 or 16:9. Press the OK button to confirm the setting.

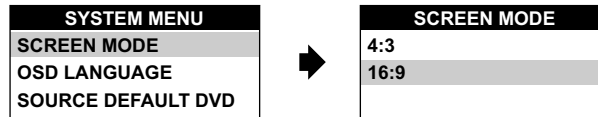

OSD LANGUAGE

This allows the user to select the language for the on-screen display. The user can either select English, Spanish, French or German for the OSD language.

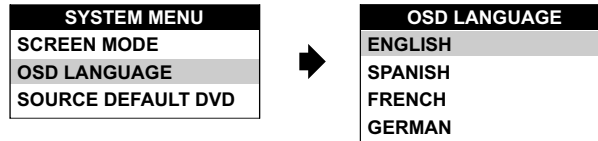

SOURCE DEFAULT DVD

This allows the user to select from:

DVD default on- When ever the unit is turned on it will return to DVD mode.

DVD default off- When ever the unit is turned on it will return to the last source selected.

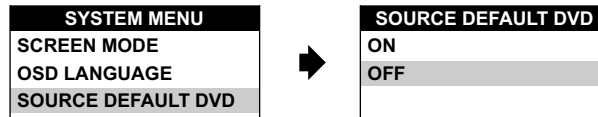

DVD SETUP MENU

The Setup Menu contains features and options that let you customize your DVD player. For example, you can set a language for the on-screen display, limit playback for children.

Using the Setup Menu

1. Press the SETUP button on the remote. The Setup Menu appears on the screen as shown per diagram.

Language	Language Setup
Video	Video Setup
Rating	Rating Setup



2. In order to Go to the desired page, move the highlight using the cursor button ◀ or ▶ to the icon indicated.
3. After entering the desired page, highlight the desired item using the cursor button ▲ or ▼.
4. Press ▶ to move the highlight to the different options for the selected item.
Press ▲ or ▼ to select the desired options, and then press ENTER to confirm the selection.
5. Repeat steps 3~4 to continue setting the items in the same Setup Page.
6. To change to another Setup page, press ◀ until the highlight moves back to the icon on the top part of the Setup Menu. Then, repeat steps 2~5.

Exiting the Setup Menu

Press the SETUP button again to exit the setup menu.

LANGUAGE SETUP

Language for On-Screen Display

OSD MENU: The OSD MENU setup allows you to select the language for the on-screen display. The user can either select English, French, Spanish, German or Italian for the OSD language.

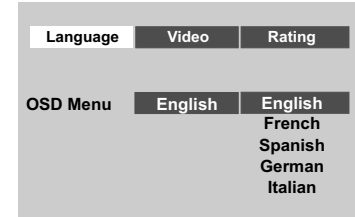

VIDEO SETUP

TV Display

The TV DISPLAY setup allows you to adjust screen setting (aspect ratio).

4:3 PS

This displays the wide picture on the screen with a portion of the left & right side removed.

4:3 LB

This displays the wide picture with black bands on the upper and lower portions of the screen.

16:9

This displays a wide picture with black bands on the upper and lower portion of the screen.

The bandwidth will vary, depending on the aspect ratio of the disc.

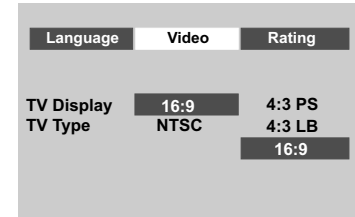

TV Type

The TV TYPE setup allows you to select the system to fit to the color system of the TV to be connected.

NTSC - Select this type for NTSC TV

PAL - Select this type for PAL TV

AUTO - Select this type for multi-system TV

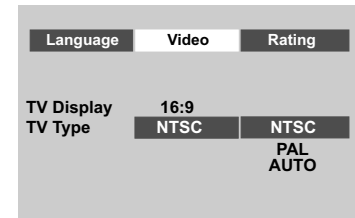

RATING SETUP

Rating

This item allows you to limit the content of movie playback from G to Adult. The lower the value, the more strict the control.

G
PG
PG – 13
R
NC – 17
Adult

The rating level can only be changed when the displayed lock is open. For first time use, key in the default password (3308) and press enter. To set a new password, key in a new four-digit password and press enter

Load Factory

The Load Factory — Reset allows you to reset all options to factory settings.

* This function will not affect the Rating control settings.

Note: *The Default Password is 3308. This password is always effective even after you have selected your own password and changed it. To avoid the possibility of others using the default password to set the parental level and change the password, you can record this default password in another area and delete it from this manual. Some discs can be limited depending on the age of users while some discs cannot.*

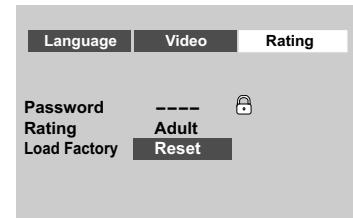
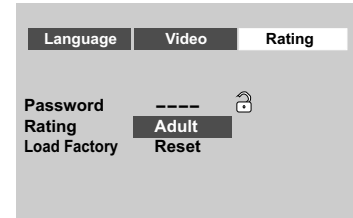
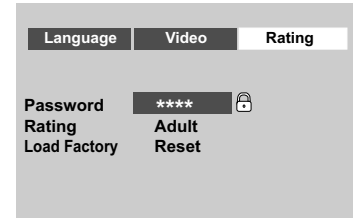

Playing Audio DVDs

1. When playing an audio CD, the DISPLAY banner appears automatically. It displays the track and amount of time for the track playing, the total amount of time on the disc and the elapsed time of the disc.

2. Selecting a Track

You can skip to a specific track by using the numbers keys. After choosing the track, press ENTER to implement the selection.

3. Using the REPEAT feature

The default mode for the Repeat feature is OFF. Pressing REPEAT consecutively changes the repeat options:

- SINGLE – repeat the track that is playing.
- ALL – repeat the entire disc that is playing.

As you toggle through the options, the repeat option changes at that time. The track, for example, repeats once that track has ended. The selected repeat option loops repeatedly until you turn it off.

Playing MP3 Discs

MP3 is a format for storing digital audio. An audio CD-quality song can be compressed into the MP3 format with very little loss of quality, while taking up much less space. CD-R discs that have been encoded in MP3 format can be played on your DVD player. The DVD player plays the songs in the order they were burned on to the disc.

Press DISPLAY button on the remote to display the time counter display elapsed only.

- Time elapsed is the time that the song has played
- Time remaining is the amount of time left for the song being played.

Selecting Folders and Songs

When an MP3 is loaded in the player, the navigation menu appears automatically.

1. Press ▲ or ▼ to move the highlight to the desired folder and press ENTER to display the songs in the folder.
2. Press ▲ or ▼ to move the highlight to the desired song and press ENTER to begin playback of the highlighted song.

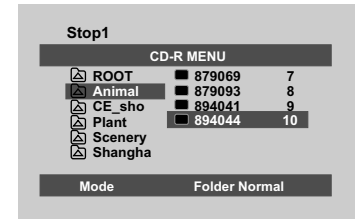

Skipping Songs

Use the Next (⏭) button on the remote control to move to the next song. Use the Previous (⏮) button to move to the previous song.

Selecting a Play Mode

You can choose what order the songs will play on a disc temporarily. The default play mode is FOLDER. Press REPEAT consecutively to choose the desired play mode. The play mode options are:

- FOLDER Plays the songs in a folder in the order they were recorded.
- SHUFFLE Plays the songs in a folder in random order (from within the selected folder).
- RANDOM Plays the songs in a folder in random order.
- SINGLE Plays a selected song.
- REPEAT ONE Repeat the song that is playing.
- REPEAT FOLDER Repeat the folder that is playing.

TURNING THE UNIT ON OR OFF

1. Pushing in the screen release button will unlock the LCD screen and it will drop down slightly. Pivot the screen downward until a comfortable viewing angle is reached. The hinge friction will hold the screen in position while the system is in use.
2. Pressing the power button* on the unit or the remote control will turn the system on or off alternately. When in use the internal backlighting will illuminate the controls.
3. After the unit has been turned on and is displaying a picture, adjust the viewing angle, by pivoting the screen to optimize the picture quality.
4. Remember to turn the unit off and pivot the LCD to the locked position when not in use.

***Note:** Unit will turn On when a Disc is inserted

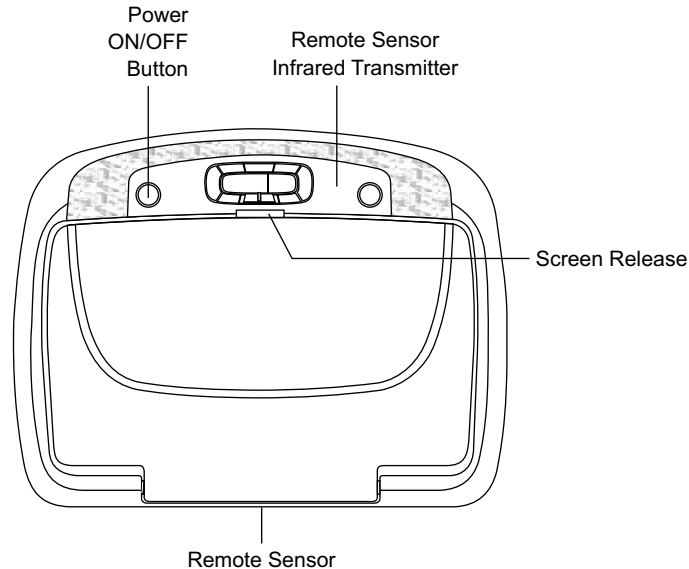

OVERHEAD DOME LIGHTS

The Dome Lights integrated into the VOD85 are controlled by a three position slide switch. Sliding the switch to the ON position will turn the lights ON. The OFF position will prevent the lights from turning ON with the vehicle's interior lighting, and the auto position will allow the lights to turn ON and OFF with the vehicle's interior lighting. Refer to the installation Guide for wire connections. Do not leave the vehicle unattended with the dome light switch in the ON position, as this could result in a discharged battery.

REMOTE SENSOR

The VOD85 incorporates two infrared remote sensors which relay signals from the remote control to allow the unit to be controlled simply by pointing its remote control at the remote sensor. The infrared sensor can relay signals from most manufacturer's remote control to its respective component connected to the AV1 input (optional accessory cable part number 8010730 required). In this case you must use the remote control supplied with the component.

ACCESSORIES

WIRELESS HEADPHONES

The VOD85 includes a built-in infrared transmitter for use with the supplied wireless headphones. The volume can then be adjusted using the controls on each headset. Any number of wireless headphones may be used but they must be used within a line of sight from the transmitter, as infrared transmissions, like visible light travel only in a straight line. See the documentation accompanying your wireless headphones.

Note: *If the monitor is set to M2 mode, the headphones supplied with this unit will not work, as these headphones are single channel. Only two-channel wireless headphones (Audiovox Model IR2CHS) will work with this unit when set to M2 mode. The only time it is necessary to set this unit to M2 mode is if there is an RSA (Rear Seat Audio) installed in the vehicle or if two of these monitors are installed in one vehicle.*

WIRED HEADPHONES (OPTIONAL)

There is one 1/8" headphone jack on the VOD85 that can be used with any standard wired stereo headphones with a 1/8" plug. This jack is controlled by the volume up/down buttons on the VOD85 remote control.

SOURCE FEATURE

AV1

The video input may be connected to a Video Cassette Player (VCP), video game system, or other audio / video devices. To access the A/V inputs, turn the VOD85 on and press the source button on the VOD85 or the Source button on the remote control until "AV1" is displayed on the screen. Turn the video source component on with its power button or remote control. The VOD85 is now ready to play the audio and video signals from the source connected to AV1 input (optional accessory cable part number 8010730 required).

AUX / Game Source

The VOD85 will accept an audio / video input through the 3 RCA jacks located on the rear of the unit. The audio / video device could be a video game system, video camera, or other input device.

Note: *The AUX/Game input is a shared input (Priority AUX) when an AUX input is connected it will automatically disable the game input.*

AV2 or TV (Optional)

The video input may be connected to a Video Cassette Player (VCP), Video game system, on other audio / video device. To access the A/V inputs, turn the VOD85 on and press the source button on the VOD85 or the source button on the remote control until AV2 is displayed on the screen.

Note: *If the optional TV tuner (PODTV2) is installed, the AV2 input becomes inactive.*

Video Out

The VOD85 provides a video output for optional video monitor(s). This output will provide a video signal that duplicates the signal displayed by the VOD85 to an additional monitor or video display. Please see your installer for more information.

USING THE WIRELESS GAME CONTROLLER

The Game Controller transmits to the VOD85 with two infrared transmitters located on the front of the Game Controller. The Game Controller must be pointed toward the VOD85 for correct operation.

Press the source button on the remote control or the unit until AUX/GAME* is displayed.

GAME CONTROLLER FUNCTIONAL DESCRIPTION

1. Install two AAA batteries in the Game Controller. Observe the correct polarity.
2. Use the ON/OFF selector switch to turn on the Game Controller. A list of ten games will be displayed.
3. Use the A button (page up) or B button (page down) to display the three pages of games (1-10, 10-20, 21-30). Then use the direction buttons to move the arrow to the desired game. Press Start to select the game.
4. Press Start to begin the game. Press Start again at any time to pause the game.
5. Press RESET to return to the game list.
6. Use the ON/OFF selector switch to turn off the Game Controller after use.

***Note:** The AUX/GAME input is a shared input. For game operation remove all plugs from the AUX input.

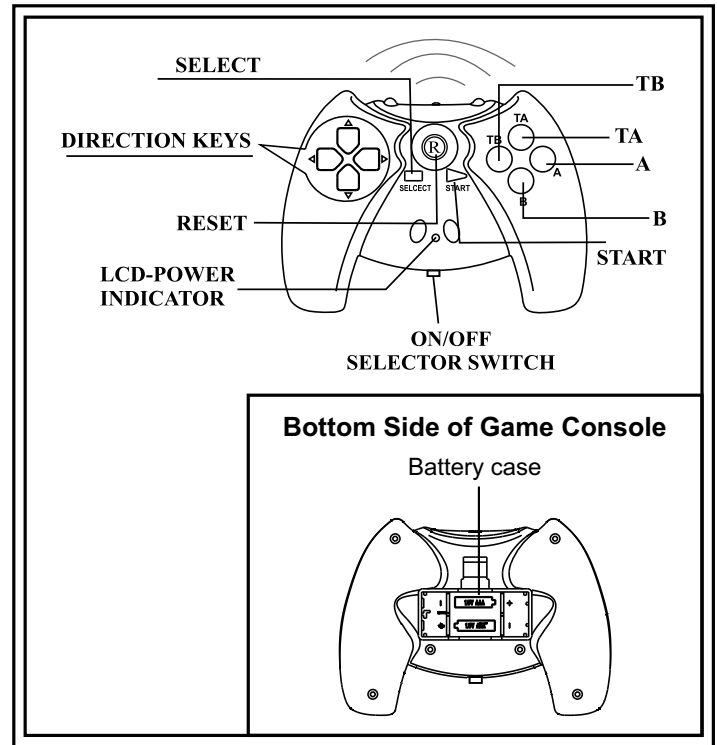

TROUBLESHOOTING

PROBLEM	SOLUTION
IR remote inoperative	<ul style="list-style-type: none">• Verify that the batteries in the remote are fresh.• Verify that the remote sensor eye is not obstructed.• If monitor is set to M1, press M1 button on remote; If monitor is set to M2, press M2 on remote.
Disc won't play	<ul style="list-style-type: none">• Insert a disc with the label side facing up.• Check the type of disc you put into disc tray. This DVD only plays DVDs, audio CDs and MP3s.• Both the unit and the disc are coded by region. If the regional codes don't match, the disc can't be played. This DVD player is set to Region Number 1.
Play starts, but then stops immediately	<ul style="list-style-type: none">• The disc is dirty. Clean it.• Condensation has formed. Allow player to dry out.
No sound or distorted sound	<ul style="list-style-type: none">• Make sure your DVD is connected properly. Make sure all cables are securely inserted into the appropriate jacks.• If you are using the 2-channel IR headphones, make sure you turn on the IR headphone power, make sure the correct channel (A-B) is selected.• Make sure the Modulator is ON and the proper Frequency has been selected.• Make sure that unit is set to M1 when using Single Channel Headphones.
Can't advance through a movie	<ul style="list-style-type: none">• You can't advance through the opening credits and warning information that appears at the beginning of movies because the disc is programmed to prohibit that action.

PROBLEM	SOLUTION
The icon (⏮) appears on screen	<ul style="list-style-type: none"> • The feature or action cannot be completed at this time because: <ol style="list-style-type: none"> 1. The disc's software restricts it. 2. The disc's software doesn't support the feature (e.g., angles) 3. The feature is not available at the moment. 4. You've requested a title or chapter number that is out of range.
Picture is distorted	<ul style="list-style-type: none"> • The disc might be damaged. Try another disc. • It is normal for some distortion to appear during forward or reverse scan.
No forward or reverse scan	<ul style="list-style-type: none"> • Some discs have sections that prohibit rapid scanning or title and chapter skip. • If you try to skip through the warning information and credits at the beginning of a movie, you won't be able to. This part of the movie is often programmed to prohibit skipping through it.

REPLACEMENT PARTS

SPECIFICATIONS

Remote Control

136-4196

LCD Backlighting

Edge Light Tube

Resolution

1440 x 234

Pixels

336, 960

Operation Temperature

32 ~131° F (0 ~ 55° C)

Storage Temperature

-4 ~ 158° F (-20 ~ 70° C)

Backlit life

10,000 Hours

Video Display System

NTSC / PAL

Headphone Audio Output

0.03W @ 32 ohms

Video Output

1.0Vp-p @ 75 ohms

Power Source

12V DC

Dimension

L x W x H

11.0" x 9.5" x 1.7"

289mm x 243mm x 44mm

Specifications subject to change without notice.



12 MONTH LIMITED WARRANTY

Applies to Audiovox Mobile Video Products

AUDIOVOX ELECTRONICS CORP. (the Company) warrants to the original retail purchaser of this product that should this product or any part thereof, under normal use and conditions, be proven defective in material or workmanship within 12 months from the date of original purchase, such defect(s) will be repaired or replaced with reconditioned product (at the Company's option) without charge for parts and repair labor. A game controller, if supplied, is similarly warranted for ninety days.

To obtain repair or replacement within the terms of this Warranty, the product is to be delivered with proof of warranty coverage (e.g. dated bill of sale), specification of defect(s), transportation prepaid, to the Company at the address shown below.

This Warranty does not extend to the elimination of externally generated static or noise, to correction of antenna problems, to costs incurred for installation, removal or reinstallation of the product, or to damage to digital memory cards, discs, speakers, accessories, or vehicle electrical systems.

This Warranty does not apply to any product or part thereof which, in the opinion of the Company, has suffered or been damaged through alteration, improper installation, mishandling, misuse, neglect, accident, or by removal or defacement of the factory serial number/bar code label(s). THE EXTENT OF THE COMPANY'S LIABILITY UNDER THIS WARRANTY IS LIMITED TO THE REPAIR OR REPLACEMENT PROVIDED ABOVE AND, IN NO EVENT, SHALL THE COMPANY'S LIABILITY EXCEED THE PURCHASE PRICE PAID BY PURCHASER FOR THE PRODUCT.

This Warranty is in lieu of all other express warranties or liabilities. ANY IMPLIED WARRANTIES, INCLUDING ANY IMPLIED WARRANTY OF MERCHANTABILITY, SHALL BE LIMITED TO THE DURATION OF THIS WRITTEN WARRANTY. ANY ACTION FOR BREACH OF ANY WARRANTY HEREUNDER INCLUDING ANY IMPLIED WARRANTY OF MERCHANTABILITY MUST BE BROUGHT WITHIN A PERIOD OF 24 MONTHS FROM DATE OF ORIGINAL PURCHASE. IN NO CASE SHALL THE COMPANY BE LIABLE FOR ANY CONSEQUENTIAL OR INCIDENTAL DAMAGES FOR BREACH OF THIS OR ANY OTHER WARRANTY, EXPRESS OR IMPLIED, WHATSOEVER. No person or representative is authorized to assume for the Company any liability other than expressed herein in connection with the sale of this product.

Some states do not allow limitations on how long an implied warranty lasts or the exclusion or limitation of incidental or consequential damage so the above limitations or exclusions may not apply to you. This Warranty gives you specific legal rights and you may also have other rights which vary from state to state.

U.S.A. : AEC 150 MARCUS BLVD., HAUPPAUGE, NEW YORK 11788 • 1-800-645-4994

CANADA: CALL 1-800-645-4994 FOR LOCATION OF WARRANTY STATION SERVING YOUR AREA

© 2006 Audiovox Electronics Corporation

128-5495E



For Customer Service
Visit Our Website At

www.audiovox.com

Product Information, Photos,
FAQ's Owner's Manuals